

# ILCD handbook

International Reference Life Cycle Data System



EUR 24708 EN - 2010

## General guide for Life Cycle Assessment - Detailed guidance

First edition

The mission of the JRC-IES is to provide scientific-technical support to the European Union's Policies for the protection and sustainable development of the European and global environment.

**Citation:** European Commission - Joint Research Centre - Institute for Environment and Sustainability: International Reference Life Cycle Data System (ILCD) Handbook - General guide for Life Cycle Assessment - Detailed guidance. First edition March 2010. EUR 24708 EN. Luxembourg. Publications Office of the European Union; 2010

European Commission  
Joint Research Centre  
Institute for Environment and Sustainability

#### Contact information

Address: Via E. Fermi, 2749 – 21027 Ispra (VA) Italy  
E-mail: [lca@jrc.ec.europa.eu](mailto:lca@jrc.ec.europa.eu)  
Fax: +39-0332-786645  
<http://lct.jrc.ec.europa.eu/>  
<http://ies.jrc.ec.europa.eu/>  
<http://www.jrc.europa.eu/>

#### Legal Notice

Neither the European Commission nor any person acting on behalf of the Commission is responsible for the use which might be made of this publication.

***Europe Direct is a service to help you find answers  
to your questions about the European Union***

**Freephone number (\*):  
00 800 6 7 8 9 10 11**

(\*) Certain mobile telephone operators do not allow access to 00 800 numbers or these calls may be billed.

A great deal of additional information on the European Union is available on the Internet. It can be accessed through the Europa server <http://europa.eu/>

JRC 48157

EUR 24708  
ISBN 978-92-79-19092-6  
ISSN 1018-5593  
doi:10.2788/38479

Luxembourg: Publications Office of the European Union

© European Union, 2010

Reproduction is authorised provided the source is acknowledged

*Printed in Italy*

## Preface

To achieve more sustainable production and consumption patterns, we must consider the environmental implications of the whole supply-chain of products, both goods and services, their use, and waste management, i.e. their entire life cycle from “cradle to grave”.

In the Communication on Integrated Product Policy (IPP), the European Commission committed to produce a handbook on best practice in Life Cycle Assessment (LCA). The Sustainable Consumption and Production Action Plan (SCP) confirmed that “(...) *consistent and reliable data and methods are required to assess the overall environmental performance of products (...)*”. The International Reference Life Cycle Data System (ILCD) Handbook provides governments and businesses with a basis for assuring quality and consistency of life cycle data, methods and assessments.

This document provides technical guidance for detailed Life Cycle Assessment (LCA) studies and provides the technical basis to derive product-specific criteria, guides, and simplified tools. The principle target audience for this guide is the LCA practitioner as well as technical experts in the public and private sector dealing with environmental decision support related to products, resources, and waste management.



## Executive summary

### Overview

Life Cycle Thinking (LCT) and Life Cycle Assessment (LCA) are the scientific approaches behind modern environmental policies and business decision support related to Sustainable Consumption and Production (SCP).

The International Reference Life Cycle Data System (ILCD) provides a common basis for consistent, robust and quality-assured life cycle data and studies. Such data and studies support coherent SCP instruments, such as Ecolabelling, Ecodesign, Carbon footprinting, and Green Public Procurement.

This guide is a component of the International Reference Life Cycle Data System (ILCD) Handbook. It provides technical guidance for detailed Life Cycle Assessment (LCA) studies and provides the technical basis to derive product-specific criteria, guides, and simplified tools. It is based on and conforms to the ISO 14040 and 14044 standards on LCA.

The principle target audience for this guide is the LCA practitioner as well as technical experts in the public and private sector dealing with environmental decision support related to products, resources, and waste management.

### About Life Cycle Assessment (LCA)

Life Cycle Assessment (LCA) is a structured, comprehensive and internationally standardised method. It quantifies all relevant emissions and resources consumed and the related environmental and health impacts and resource depletion issues that are associated with any goods or services ("products").

Life Cycle Assessment takes into account a product's full life cycle: from the extraction of resources, through production, use, and recycling, up to the disposal of remaining waste. Critically, LCA studies thereby help to avoid resolving one environmental problem while creating others: This unwanted "shifting of burdens" is where you reduce the environmental impact at one point in the life cycle, only to increase it at another point. Therefore, LCA helps to avoid, for example, causing waste-related issues while improving production technologies, increasing land use or acid rain while reducing greenhouse gases, or increasing emissions in one country while reducing them in another.

Life Cycle Assessment is therefore a vital and powerful decision support tool, complementing other methods, which are equally necessary to help effectively and efficiently make consumption and production more sustainable.

### About the International Reference Life Cycle Data System (ILCD)

The ISO 14040 and 14044 standards provide the indispensable framework for Life Cycle Assessment (LCA). This framework, however, leaves the individual practitioner with a range of choices, which can affect the legitimacy of the results of an LCA study.

While flexibility is essential in responding to the large variety of questions addressed, further guidance is needed to support consistency and quality assurance. The International Reference Life Cycle Data System (ILCD) has therefore been developed to provide guidance for consistent and quality assured Life Cycle Assessment data and studies.

The ILCD consists primarily of the ILCD Handbook and the ILCD Data Network. This document you are reading is part of the ILCD Handbook: The ILCD Handbook is a series of technical documents providing guidance for good practice in Life Cycle Assessment in business and government. It is supported by templates, tools, and other components.

The ILCD Handbook equally serves as a "parent" document for developing sector and product-group specific guidance documents, criteria, and simplified ecodesign-type tools.

Such are seen as the most appropriate solutions for enabling the efficient use of reliable and robust life cycle approaches in Small and Medium Enterprises (SME).

The development of the ILCD has been coordinated by the European Commission and has been carried out through a broad international consultation process with experts, stakeholders, and the public.

### Role of this document within the ILCD Handbook

This document provides detailed guidance for planning, developing, and reporting both life cycle emission and resource consumption inventory (LCI) data sets and Life Cycle Assessment studies. The exact provisions are given at the end of the chapters. These "Provisions" are also available in a separate 'cook-book' style guide for daily reference for the more experienced practitioners and reviewers.

This document also serves as an introduction to the main principles and concepts of Life Cycle Assessment. It is not intended, however, to be a comprehensive and detailed introduction or training manual for beginners.

Within the ILCD Handbook, this document has the role of providing the general, overarching guidance for detailed Life Cycle Assessment (see figure).

It is complemented by specific guides on the development of Life Cycle Inventory (LCI) data sets, the development of Life Cycle Impact Assessment models & indicators, as well as on performing reviews of LCI data sets, LCA studies, and of specific guides and simplified approaches.

This guide is further supported with an LCA study report template, an LCI data set documentation format, a document on nomenclature and other conventions, and a terminology. These supporting documents and applications are available separately.

### Approach taken and key issues addressed in this document

This document further details the ISO 14044 provisions and differentiates them for the three main types of questions that are addressed with LCA studies:

- **"Micro-level decision support"**: Life cycle based decision support on micro-level, i.e. typically for questions related to specific products. "Micro-level decisions" are assumed to have limited and no structural consequences outside the decision-context, i.e. they are supposed not to change available production capacity.
- **"Meso/macro-level decision support"**: Life cycle based decision support at a strategic level (e.g. raw materials strategies, technology scenarios, policy options). "Meso/macro-level decisions" are assumed to have structural consequences outside the decision-context, i.e. they are supposed to change available production capacity.
- **"Accounting"**: Purely descriptive documentation of the system's life cycle under analysis (e.g. a product, sector, or country), without being interested in any potential additional consequences on other parts of the economy.

Focus is given to methodological issues that result in relevant differences in current practice of developing Life Cycle Inventory data sets and performing LCA studies.

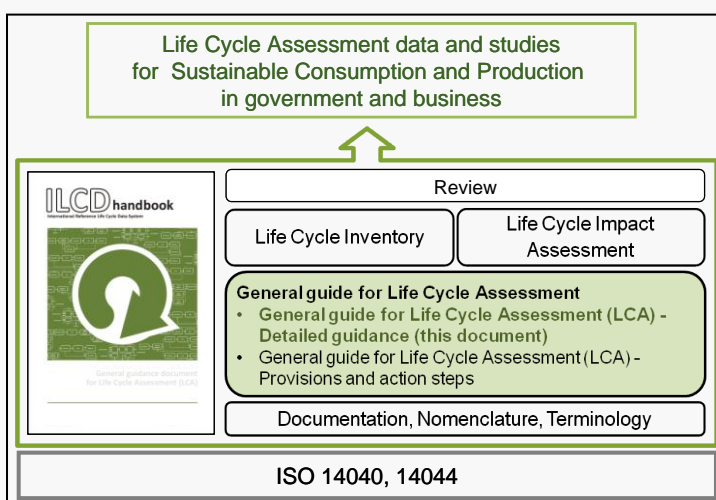

## CONTENTS

EXECUTIVE SUMMARY.....	.IV
<b>1 INTRODUCTION AND OVERVIEW .....</b>	<b>1</b>
<b>2 HOW TO USE THIS DOCUMENT .....</b>	<b>5</b>
<b>2.1 Structure of the document .....</b>	<b>5</b>
<b>2.2 How to work with this document .....</b>	<b>7</b>
2.2.1 Overview .....	7
2.2.2 Theoretical approaches and simplifications .....	7
2.2.3 Overview of differences in the provisions for the Situations A, B, and C .....	8
2.2.4 How to perform an LCI or LCA study in accordance with this document .....	10
<b>2.3 ILCD compliance and the "Provisions" within this document.....</b>	<b>16</b>
<b>2.4 Dealing with potential omissions and contradictions in the ILCD Handbook... 17</b>	<b>17</b>
<b>Provisions: 2 How to use this document.....</b>	<b>18</b>
<b>3 KEY DEFINITIONS .....</b>	<b>21</b>
<b>4 THE ITERATIVE APPROACH TO LCA.....</b>	<b>25</b>
<b>Provisions: 4 The iterative approach to LCA .....</b>	<b>28</b>
<b>5 GOAL DEFINITION – IDENTIFYING PURPOSE AND TARGET AUDIENCE.....</b>	<b>29</b>
<b>5.1 Introduction and overview.....</b>	<b>29</b>
<b>5.2 Six aspects of the goal definition .....</b>	<b>30</b>
5.2.1 Intended application(s).....	30
5.2.2 Method, assumption and impact limitations (e.g. Carbon footprint) .....	32
5.2.3 Reasons for carrying out the study, and decision-context .....	33
5.2.4 Target audience .....	34
5.2.5 Comparisons intended to be disclosed to the public.....	34
5.2.6 Commissioner of the study and other influential actors .....	35
<b>Provisions: 5.2 Six aspects of goal definition.....</b>	<b>35</b>
<b>5.3 Classifying the decision-context as Situation A, B, or C .....</b>	<b>36</b>
5.3.1 Possible decision-context situations .....	36
5.3.2 Studies on decisions .....	37
5.3.3 Studies of descriptive character .....	37
5.3.4 Situation A.....	38
5.3.5 Situation B.....	40
5.3.6 Guidance for clearly differentiating between Situation A and B .....	41
5.3.7 Situation C .....	43
5.3.8 Guidance for clearly differentiating between Situation C and A / B.....	45
<b>Provisions: 5.3 Classifying the decision-context .....</b>	<b>46</b>
<b>5.4 Need for flexibility versus strictness.....</b>	<b>49</b>
<b>Provisions: 5.4 Need for flexibility versus strictness.....</b>	<b>49</b>
<b>5.5 Optionally extending the goal.....</b>	<b>50</b>
<b>Provisions: 5.5 Optionally extending the goal .....</b>	<b>50</b>
<b>6 SCOPE DEFINITION - WHAT TO ANALYSE AND HOW .....</b>	<b>51</b>
<b>6.1 Introduction and overview.....</b>	<b>51</b>
<b>6.2 Overview and basic requirements .....</b>	<b>52</b>

6.2.1	Consistency of methods, assumptions, and data.....	52
	<b>Provisions: 6.2.1 Consistency of methods, assumptions and data.....</b>	<b>52</b>
6.2.2	Reproducibility.....	53
	<b>Provisions: 6.2.2 Reproducibility .....</b>	<b>54</b>
<b>6.3</b>	<b>Types of LCI and LCA deliverables and intended applications.....</b>	<b>54</b>
	<b>Provisions: 6.3 Types of LCA deliverables and intended applications .....</b>	<b>59</b>
<b>6.4</b>	<b>Function, functional unit, and reference flow.....</b>	<b>59</b>
6.4.1	Detailed identification of the process(es) or system(s) to be analysed .....	59
6.4.2	Quantitative aspects of the functional unit .....	61
6.4.3	Qualitative aspects of the functional unit.....	62
6.4.4	Working with obligatory and positioning properties.....	63
6.4.5	Using technical standards for defining function and functional unit .....	64
6.4.6	Functional unit and/or reference flow? .....	65
6.4.7	Comparisons of systems and the functional unit.....	67
	<b>Provisions: 6.4 Function, functional unit, and reference flow.....</b>	<b>68</b>
<b>6.5</b>	<b>Life Cycle Inventory (LCI) modelling framework.....</b>	<b>70</b>
6.5.1	Introduction and overview .....	70
6.5.2	The two main LCI modelling principles .....	70
6.5.3	LCI method approaches for solving multifunctionality .....	72
6.5.3.1	Introduction .....	72
6.5.3.2	The ISO hierarchy for solving multifunctionality .....	74
6.5.4	LCI modelling provisions for Situations A, B, and C.....	81
6.5.4.1	Introduction and overview.....	81
6.5.4.2	Situation A: "Micro-level decision support" .....	81
6.5.4.2.1	Overview.....	81
6.5.4.2.2	LCI modelling provisions.....	82
6.5.4.3	Situation B: "Meso/macro-level decision support" .....	85
6.5.4.3.1	Overview.....	85
6.5.4.3.2	LCI modelling provisions.....	85
6.5.4.4	Situation C: "Accounting" .....	86
	<b>Provisions: 6.5.4 LCI modelling provisions for Situations A, B, and C .....</b>	<b>87</b>
<b>6.6</b>	<b>Deriving system boundaries and cut-off criteria (completeness) .....</b>	<b>93</b>
6.6.1	Introduction and overview .....	93
6.6.2	Qualitative definition of system boundaries.....	100
6.6.3	Quantitative definition of system boundaries – the cut-off criteria.....	102
	<b>Provisions: 6.6 Deriving system boundaries and cut-off criteria (completeness).....</b>	<b>105</b>
<b>6.7</b>	<b>Preparing the basis for the impact assessment.....</b>	<b>108</b>
6.7.1	Introduction and overview .....	108
6.7.2	Identifying LCIA methods to be applied .....	109
6.7.3	Carbon footprint and other selected indicators .....	111
6.7.4	Inclusion of non-standard impacts and of non-standard elementary flows .....	111
6.7.5	Spatial and other differentiation / modification of impact factors .....	112
6.7.6	Selection of normalisation basis and weighting set.....	113
6.7.7	Documentation of decision on LCIA methods, impact level, normalisation basis, and weighting factors .....	115
	<b>Provisions: 6.7 Preparing the basis for the impact assessment.....</b>	<b>116</b>



<b>6.8 Representativeness and appropriateness of LCI data .....</b>	<b>122</b>
6.8.1 Introduction and overview .....	122
6.8.2 Technological representativeness.....	123
<b>Provisions: 6.8.2 Technological representativeness.....</b>	<b>126</b>
6.8.3 Geographical representativeness .....	128
<b>Provisions: 6.8.3 Geographical representativeness .....</b>	<b>131</b>
6.8.4 Time-related representativeness.....	132
<b>Provisions: 6.8.4 Time-related representativeness .....</b>	<b>134</b>
<b>6.9 Types, quality and sources of required data and information.....</b>	<b>135</b>
6.9.1 Introduction and overview .....	135
6.9.2 Data quality needs in light of the intended applications .....	136
6.9.3 Inventory data needs and sources .....	137
6.9.4 Other inventory-related data and information needs and sources .....	138
6.9.5 Impact assessment models and factors, normalisation basis, and weighting set needs	138
<b>Provisions: 6.9 Types, quality and sources of required data and information .....</b>	<b>139</b>
<b>6.10 Comparisons between systems.....</b>	<b>140</b>
6.10.1 Introduction and overview .....	140
6.10.2 Strengthening affected stakeholders in non-assertive comparisons and multi system type studies.....	140
6.10.3 Considered alternatives, the functional unit, and assumptions .....	142
6.10.4 Methodological, assumptions and data consistency .....	143
6.10.5 Data quality requirements .....	144
6.10.6 Identical parts of the compared systems.....	144
6.10.7 Scenarios in support of comparisons .....	144
6.10.8 Carbon footprint studies and other selected comparisons .....	145
<b>Provisions: 6.10 Comparisons between systems.....</b>	<b>145</b>
<b>6.11 Identifying critical review needs.....</b>	<b>148</b>
<b>Provisions: 6.11 Identifying critical review needs .....</b>	<b>149</b>
<b>6.12 Planning reporting .....</b>	<b>149</b>
<b>Provisions: 6.12 Planning reporting.....</b>	<b>151</b>
<b>7 LIFE CYCLE INVENTORY ANALYSIS - COLLECTING DATA, MODELLING THE SYSTEM, CALCULATING RESULTS .....</b>	<b>153</b>
<b>7.1 Introduction and overview.....</b>	<b>153</b>
<b>7.2 Identifying processes within the system boundaries.....</b>	<b>154</b>
7.2.1 Introduction and overview .....	154
7.2.2 Part-system and system-system relationships.....	155
7.2.3 Identifying processes in attributional modelling.....	158
7.2.3.1 Introduction and overview.....	158
7.2.3.2 Processes to be attributed to the analysed system.....	159
7.2.3.3 Initial description of identified processes .....	162
<b>Provisions: 7.2.3 Identifying processes in attributional modelling.....</b>	<b>162</b>
7.2.4 Identifying processes in consequential modelling .....	164
7.2.4.1 Introduction and overview.....	164
7.2.4.2 Consequences to be considered.....	166
7.2.4.3 Constraints and other market imperfections to be considered .....	169

7.2.4.4	Identifying the processes of the consequential model.....	169
7.2.4.5	Further aspects, recommendations, and observations .....	172
7.2.4.6	Solving multifunctionality of processes in consequential modelling .....	174
7.2.4.7	Initial description of identified processes .....	175
	<b>Provisions: 7.2.4 Identifying processes in consequential modelling .....</b>	<b>175</b>
<b>7.3</b>	<b>Planning data collection .....</b>	<b>183</b>
7.3.1	Overview .....	183
7.3.2	Foreground system data - specific, average, or generic .....	184
7.3.3	Background data for attributional and consequential models .....	185
7.3.4	Need for multi-annual average data or generic data.....	186
7.3.5	Primary and secondary data sources.....	187
7.3.6	Focus on most relevant data and information .....	187
	<b>Provisions: 7.3 Planning data collection .....</b>	<b>188</b>
<b>7.4</b>	<b>Collecting unit process LCI data .....</b>	<b>190</b>
7.4.1	Introduction and overview .....	190
7.4.2	Basic data collection towards unit processes.....	191
7.4.2.1	Introduction and overview.....	191
7.4.2.2	Avoiding black box unit processes by subdivision and virtual subdivision .....	192
	<b>Provisions: 7.4.2.2 Avoiding black box unit processes by subdivision and virtual subdivision .....</b>	<b>194</b>
7.4.2.3	Describing what the modelled unit process represents.....	195
	<b>Provisions: 7.4.2.3 Describing what the unit process represents.....</b>	<b>195</b>
7.4.2.4	Types of input and output flows to collect.....	196
	<b>Provisions: 7.4.2.4 Types of input and output flows to collect .....</b>	<b>196</b>
7.4.2.5	Data and information types for specific, future and generic data sets .....	197
	<b>Provisions: 7.4.2.5 Data and information types for specific, future and generic data sets.....</b>	<b>199</b>
7.4.2.6	Reference amount of the reference flow .....	200
	<b>Provisions: 7.4.2.6 Reference amount of the reference flow .....</b>	<b>200</b>
7.4.2.7	Representativeness regarding operation conditions .....	201
	<b>Provisions: 7.4.2.7 Representativeness regarding operation conditions .....</b>	<b>201</b>
7.4.2.8	Checking legal limits .....	202
	<b>Provisions: 7.4.2.8 Checking legal limits.....</b>	<b>202</b>
7.4.2.9	From raw data to unit process inventory .....	203
	<b>Provisions: 7.4.2.9 From raw data to unit process inventory .....</b>	<b>204</b>
7.4.2.10	Solving confidentiality issues .....	204
	<b>Provisions: 7.4.2.10 Solving confidentiality issues .....</b>	<b>204</b>
7.4.2.11	Interim quality control for improving data quality .....	205
7.4.2.11.1	<i>General approach.....</i>	205
7.4.2.11.2	<i>Obtaining better unit process data.....</i>	206
7.4.2.11.3	<i>Dealing with remaining unit process data gaps / missing data .....</i>	209
7.4.2.11.4	<i>Documentation .....</i>	210
	<b>Provisions: 7.4.2.11 Interim quality control.....</b>	<b>211</b>
7.4.3	Overarching method provisions for specific elementary flow types .....	214
7.4.3.1	Introduction and overview.....	214
7.4.3.2	Emission of measurement indicators and elementary flow groups .....	215
	<b>Provisions: 7.4.3.2 Emission of measurement indicators and elementary flow groups.....</b>	<b>216</b>
7.4.3.3	Emission of ionic compounds .....	218
	<b>Provisions: 7.4.3.3 Emission of ionic compounds .....</b>	<b>218</b>

7.4.3.4	Emission of particles to air.....	218
	<b>Provisions: 7.4.3.4 Emission of particles to air.....</b>	<b>220</b>
7.4.3.5	Emission of substances of complementary, alternative action schemes .....	220
7.4.3.6	Resource elementary flows .....	220
7.4.3.6.1	<i>Energy resources</i> .....	220
7.4.3.6.2	<i>Ores for winning metals or other elemental constituents</i> .....	221
7.4.3.6.3	<i>Land use</i> .....	221
7.4.3.6.4	<i>Fossil and biological CO<sub>2</sub> uptake and release of CO<sub>2</sub> and CH<sub>4</sub></i> .....	222
7.4.3.6.5	<i>Water use</i> .....	222
	<b>Provisions: 7.4.3.6 Resource elementary flows .....</b>	<b>223</b>
7.4.3.7	Future processes and elementary flows.....	225
7.4.3.7.1	<i>Introduction and overview</i> .....	225
7.4.3.7.2	<i>Differentiating the inventory of interventions in the more remote future (long-term emissions beyond 100 years)</i> .....	225
7.4.3.7.3	<i>Temporary carbon storage, delayed greenhouse gas emissions, delayed credits for solving multifunctionality</i> .....	226
7.4.3.7.4	<i>Long-term storage of potential emissions beyond 100 years</i> .....	229
	<b>Provisions: 7.4.3.7 Future processes and elementary flows .....</b>	<b>229</b>
7.4.3.8	Reminder flows .....	232
	<b>Provisions: 7.4.3.8 Reminder flows .....</b>	<b>232</b>
7.4.4	Overarching method provisions for specific process types .....	233
7.4.4.1	Modelling agro- and forestry systems.....	233
	<b>Provisions: 7.4.4.1 Modelling agro- and forestry systems.....</b>	<b>238</b>
7.4.4.2	Modelling waste treatment.....	242
	<b>Provisions: 7.4.4.2 Modelling waste treatment .....</b>	<b>244</b>
7.4.5	Naming and other conventions .....	244
	<b>Provisions: 7.4.5 Naming and other conventions.....</b>	<b>245</b>
<b>7.5</b>	<b>Developing generic LCI data.....</b>	<b>246</b>
<b>7.6</b>	<b>Selecting secondary LCI data sets .....</b>	<b>247</b>
	<b>Provisions: 7.6 Selecting secondary LCI data sets .....</b>	<b>248</b>
<b>7.7</b>	<b>Averaging LCI data.....</b>	<b>248</b>
<b>7.8</b>	<b>Modelling the system.....</b>	<b>251</b>
	<b>Provisions: 7.8 Modelling the system .....</b>	<b>253</b>
<b>7.9</b>	<b>Solving multifunctionality of processes in attributional modelling .....</b>	<b>254</b>
7.9.1	Introduction and overview .....	254
7.9.2	Avoiding allocation by subdivision of virtual subdivision .....	255
	<b>Provisions: 7.9.2 Avoiding allocation by subdivision or virtual subdivision .....</b>	<b>256</b>
7.9.3	Solving multifunctionality by allocation.....	257
7.9.3.1	Overview .....	257
7.9.3.2	First criterion “Determining physical causality” .....	257
7.9.3.3	Second (general) criterion “Economic value” or QFD .....	263
	<b>Provisions: 7.9.3 Solving multifunctionality by allocation.....</b>	<b>266</b>
<b>7.10</b>	<b>Calculating LCI results .....</b>	<b>273</b>
	<b>Provisions: 7.10 Calculating LCI results.....</b>	<b>273</b>
<b>8</b>	<b>LIFE CYCLE IMPACT ASSESSMENT - CALCULATING LCIA RESULTS.....</b>	<b>275</b>
<b>8.1</b>	<b>Introduction and overview.....</b>	<b>275</b>
<b>8.2</b>	<b>Calculation of LCIA results .....</b>	<b>276</b>
	<b>Provisions: 8.2 Calculation of LCIA results.....</b>	<b>280</b>
<b>8.3</b>	<b>Normalisation .....</b>	<b>281</b>

	<b>Provisions: 8.3 Normalisation</b> .....	<b>282</b>
<b>8.4</b>	<b>Weighting</b> .....	<b>282</b>
	<b>Provisions: 8.4 Weighting</b> .....	<b>283</b>
<b>9</b>	<b>LIFE CYCLE INTERPRETATION</b> .....	<b>285</b>
<b>9.1</b>	<b>Introduction and overview</b> .....	<b>285</b>
<b>9.2</b>	<b>Identification of significant issues</b> .....	<b>286</b>
	<b>Provisions: 9.2 Identification of significant issues</b> .....	<b>287</b>
<b>9.3</b>	<b>Evaluation</b> .....	<b>288</b>
9.3.1	Introduction and overview .....	288
9.3.2	Completeness check.....	289
	<b>Provisions: 9.3.2 Completeness check</b> .....	<b>293</b>
9.3.3	Sensitivity check (of achieved accuracy and precision) .....	295
	<b>Provisions: 9.3.3 Sensitivity check (of accuracy and precision)</b> .....	<b>298</b>
9.3.4	Consistency check .....	299
	<b>Provisions: 9.3.4 Consistency check</b> .....	<b>300</b>
<b>9.4</b>	<b>Conclusions, limitations, and recommendations</b> .....	<b>300</b>
	<b>Provisions: 9.4 Conclusions, limitations, and recommendations</b> .....	<b>304</b>
<b>10</b>	<b>REPORTING</b> .....	<b>307</b>
<b>10.1</b>	<b>Introduction and overview</b> .....	<b>307</b>
<b>10.2</b>	<b>Reporting principles</b> .....	<b>307</b>
	<b>Provisions: 10.2 Reporting principles</b> .....	<b>308</b>
<b>10.3</b>	<b>Three levels of reporting requirements</b> .....	<b>309</b>
10.3.1	Report for internal use.....	309
10.3.2	Third party report.....	309
10.3.3	Report on comparative studies to be disclosed to the public .....	310
10.3.4	Reporting elements .....	310
	<b>Provisions: 10.3 Three levels of reporting requirements</b> .....	<b>314</b>
<b>11</b>	<b>CRITICAL REVIEW</b> .....	<b>321</b>
	<b>Provisions: 11 Critical review</b> .....	<b>321</b>
<b>12</b>	<b>ANNEX A: DATA QUALITY CONCEPT AND APPROACH</b> .....	<b>323</b>
<b>12.1</b>	<b>Introduction and overview</b> .....	<b>323</b>
<b>12.2</b>	<b>Data quality aspects</b> .....	<b>324</b>
<b>12.3</b>	<b>Data quality indicators</b> .....	<b>329</b>
<b>12.4</b>	<b>ILCD Handbook compliance criteria</b> .....	<b>333</b>
<b>13</b>	<b>ANNEX B: CALCULATION OF CO<sub>2</sub> EMISSIONS FROM LAND TRANSFORMATION</b> .....	<b>337</b>
<b>14</b>	<b>ANNEX C: MODELLING REUSE, RECYCLING, AND ENERGY RECOVERY</b> .....	<b>343</b>
<b>14.1</b>	<b>Introduction and overview</b> .....	<b>343</b>
<b>14.2</b>	<b>True joint process and true co-product</b> .....	<b>345</b>
<b>14.3</b>	<b>Concepts: Closed-loop and open-loop recycling</b> .....	<b>346</b>
14.3.1	Closed-loop recycling.....	346
14.3.2	Open-loop recycling .....	347
14.3.2.1	Open loop - same primary route .....	348
14.3.2.2	Open loop - different primary route.....	348
<b>14.4</b>	<b>Recycling in attributional modelling</b> .....	<b>349</b>
14.4.1	Detailed aspects of attributional modelling of recycling .....	349

14.4.1.1 Introduction .....	349
14.4.1.2 Market value of waste / end-of-life product is above zero, i.e. it is a co-product.....	350
14.4.1.3 Market value of waste / end-of-life product is negative (i.e. a waste treatment fee is to be paid) 352	
<b>14.5 Recycling in consequential modelling .....</b>	<b>354</b>
14.5.1 Introduction and overview .....	354
14.5.2 Recyclability substitution approach .....	354
14.5.3 Detailed aspects of using the recyclability substitution approach of consequential modelling .....	358
14.5.3.1 Introduction .....	358
14.5.3.2 Determining recyclability .....	358
14.5.3.3 Changes of inherent technical properties of the secondary good .....	359
14.5.3.4 Identifying superseded processes in line with market consequences to consider ...	360
14.5.3.5 Time aspects in “delayed” recycling of long-living products .....	363
<b>15 ANNEX D: AVOIDING MISLEADING GOAL AND SCOPE DEFINITION AND RESULTS INTERPRETATION.....</b>	<b>365</b>
<b>15.1 Introduction and overview.....</b>	<b>365</b>
<b>15.2 Misleading goal definition and scoping .....</b>	<b>365</b>
15.2.1 Functional unit.....	366
15.2.2 Modelling principle .....	367
15.2.3 Drawing of system boundaries.....	367
15.2.4 Choice of LCIA impact categories, LCIA methods, normalisation and weighting sets 368	
15.2.5 Representativeness of data .....	369
15.2.5.1 Technological representativeness .....	369
15.2.5.2 Geographical representativeness.....	370
15.2.5.3 Time-related representativeness .....	370
15.2.6 Consistency in comparison of systems and products .....	371
<b>15.3 Misleading interpretation.....</b>	<b>371</b>
<b>15.4 Misleading reporting and communication .....</b>	<b>372</b>
<b>15.5 Integrated example of misleading goal and scope definition and interpretation: cups for hot drinks .....</b>	<b>373</b>
<b>16 ANNEX E: ADDRESSING UNCERTAINTIES IN LCA.....</b>	<b>377</b>
<b>16.1 Introduction and overview.....</b>	<b>377</b>
<b>16.2 Types and sources of uncertainty in LCA .....</b>	<b>377</b>
<b>16.3 Aggregating uncertainties over the life cycle.....</b>	<b>379</b>
<b>17 ANNEX F: SYSTEM BOUNDARY TEMPLATE .....</b>	<b>381</b>
<b>18 ANNEX G: DEVELOPMENT OF THIS DOCUMENT .....</b>	<b>383</b>

## PROVISIONS

<b>PROVISIONS: 2 HOW TO USE THIS DOCUMENT .....</b>	<b>18</b>
<b>PROVISIONS: 4 THE ITERATIVE APPROACH TO LCA .....</b>	<b>28</b>
<b>PROVISIONS: 5.2 SIX ASPECTS OF GOAL DEFINITION .....</b>	<b>35</b>
<b>PROVISIONS: 5.3 CLASSIFYING THE DECISION-CONTEXT .....</b>	<b>46</b>
<b>PROVISIONS: 5.4 NEED FOR FLEXIBILITY VERSUS STRICTNESS.....</b>	<b>49</b>
<b>PROVISIONS: 5.5 OPTIONALLY EXTENDING THE GOAL .....</b>	<b>50</b>
<b>PROVISIONS: 6.2.1 CONSISTENCY OF METHODS, ASSUMPTIONS AND DATA .....</b>	<b>52</b>
<b>PROVISIONS: 6.2.2 REPRODUCIBILITY .....</b>	<b>54</b>
<b>PROVISIONS: 6.3 TYPES OF LCA DELIVERABLES AND INTENDED APPLICATIONS .....</b>	<b>59</b>
<b>PROVISIONS: 6.4 FUNCTION, FUNCTIONAL UNIT, AND REFERENCE FLOW .....</b>	<b>68</b>
<b>PROVISIONS: 6.5.4 LCI MODELLING PROVISIONS FOR SITUATIONS A, B, AND C.....</b>	<b>87</b>
<b>PROVISIONS: 6.6 DERIVING SYSTEM BOUNDARIES AND CUT-OFF CRITERIA (COMPLETENESS) .....</b>	<b>105</b>
<b>PROVISIONS: 6.7 PREPARING THE BASIS FOR THE IMPACT ASSESSMENT .....</b>	<b>116</b>
<b>PROVISIONS: 6.8.2 TECHNOLOGICAL REPRESENTATIVENESS .....</b>	<b>126</b>
<b>PROVISIONS: 6.8.3 GEOGRAPHICAL REPRESENTATIVENESS.....</b>	<b>131</b>
<b>PROVISIONS: 6.8.4 TIME-RELATED REPRESENTATIVENESS.....</b>	<b>134</b>
<b>PROVISIONS: 6.9 TYPES, QUALITY AND SOURCES OF REQUIRED DATA AND INFORMATION</b>	<b>139</b>
<b>PROVISIONS: 6.10 COMPARISONS BETWEEN SYSTEMS.....</b>	<b>145</b>
<b>PROVISIONS: 6.11 IDENTIFYING CRITICAL REVIEW NEEDS .....</b>	<b>149</b>
<b>PROVISIONS: 6.12 PLANNING REPORTING.....</b>	<b>151</b>
<b>PROVISIONS: 7.2.3 IDENTIFYING PROCESSES IN ATTRIBUTIONAL MODELLING .....</b>	<b>162</b>
<b>PROVISIONS: 7.2.4 IDENTIFYING PROCESSES IN CONSEQUENTIAL MODELLING .....</b>	<b>175</b>
<b>PROVISIONS: 7.3 PLANNING DATA COLLECTION.....</b>	<b>188</b>
<b>PROVISIONS: 7.4.2.2 AVOIDING BLACK BOX UNIT PROCESSES BY SUBDIVISION AND VIRTUAL SUBDIVISION .....</b>	<b>194</b>
<b>PROVISIONS: 7.4.2.3 DESCRIBING WHAT THE UNIT PROCESS REPRESENTS.....</b>	<b>195</b>
<b>PROVISIONS: 7.4.2.4 TYPES OF INPUT AND OUTPUT FLOWS TO COLLECT.....</b>	<b>196</b>
<b>PROVISIONS: 7.4.2.5 DATA AND INFORMATION TYPES FOR SPECIFIC, FUTURE AND GENERIC DATA SETS .....</b>	<b>199</b>
<b>PROVISIONS: 7.4.2.6 REFERENCE AMOUNT OF THE REFERENCE FLOW .....</b>	<b>200</b>
<b>PROVISIONS: 7.4.2.7 REPRESENTATIVENESS REGARDING OPERATION CONDITIONS.....</b>	<b>201</b>
<b>PROVISIONS: 7.4.2.8 CHECKING LEGAL LIMITS.....</b>	<b>202</b>
<b>PROVISIONS: 7.4.2.9 FROM RAW DATA TO UNIT PROCESS INVENTORY.....</b>	<b>204</b>
<b>PROVISIONS: 7.4.2.10 SOLVING CONFIDENTIALITY ISSUES .....</b>	<b>204</b>
<b>PROVISIONS: 7.4.2.11 INTERIM QUALITY CONTROL .....</b>	<b>211</b>
<b>PROVISIONS: 7.4.3.3 EMISSION OF MEASUREMENT INDICATORS AND ELEMENTARY FLOW GROUPS .....</b>	<b>216</b>
<b>PROVISIONS: 7.4.3.3 EMISSION OF IONIC COMPOUNDS .....</b>	<b>218</b>
<b>PROVISIONS: 7.4.3.4 EMISSION OF PARTICLES TO AIR .....</b>	<b>220</b>

<b>PROVISIONS: 7.4.3.6 RESOURCE ELEMENTARY FLOWS</b> .....	<b>223</b>
<b>PROVISIONS: 7.4.3.7 FUTURE PROCESSES AND ELEMENTARY FLOWS</b> .....	<b>229</b>
<b>PROVISIONS: 7.4.3.8 REMINDER FLOWS</b> .....	<b>232</b>
<b>PROVISIONS: 7.4.4.1 MODELLING AGRO- AND FORESTRY SYSTEMS</b> .....	<b>238</b>
<b>PROVISIONS: 7.4.4.2 MODELLING WASTE TREATMENT</b> .....	<b>244</b>
<b>PROVISIONS: 7.4.5 NAMING AND OTHER CONVENTIONS</b> .....	<b>245</b>
<b>PROVISIONS: 7.6 SELECTING SECONDARY LCI DATA SETS</b> .....	<b>248</b>
<b>PROVISIONS: 7.8 MODELLING THE SYSTEM</b> .....	<b>253</b>
<b>PROVISIONS: 7.9.2 AVOIDING ALLOCATION BY SUBDIVISION OR VIRTUAL SUBDIVISION</b> ....	<b>256</b>
<b>PROVISIONS: 7.9.3 SOLVING MULTIFUNCTIONALITY BY ALLOCATION</b> .....	<b>266</b>
<b>PROVISIONS: 7.10 CALCULATING LCI RESULTS</b> .....	<b>273</b>
<b>PROVISIONS: 8.2 CALCULATION OF LCIA RESULTS</b> .....	<b>280</b>
<b>PROVISIONS: 8.3 NORMALISATION</b> .....	<b>282</b>
<b>PROVISIONS: 8.4 WEIGHTING</b> .....	<b>283</b>
<b>PROVISIONS: 9.2 IDENTIFICATION OF SIGNIFICANT ISSUES</b> .....	<b>287</b>
<b>PROVISIONS: 9.3.2 COMPLETENESS CHECK</b> .....	<b>293</b>
<b>PROVISIONS: 9.3.3 SENSITIVITY CHECK (OF ACCURACY AND PRECISION)</b> .....	<b>298</b>
<b>PROVISIONS: 9.3.4 CONSISTENCY CHECK</b> .....	<b>300</b>
<b>PROVISIONS: 9.4 CONCLUSIONS, LIMITATIONS, AND RECOMMENDATIONS</b> .....	<b>304</b>
<b>PROVISIONS: 10.2 REPORTING PRINCIPLES</b> .....	<b>308</b>
<b>PROVISIONS: 10.3 THREE LEVELS OF REPORTING REQUIREMENTS</b> .....	<b>314</b>
<b>PROVISIONS: 11 CRITICAL REVIEW</b> .....	<b>321</b>

## FIGURES

Figure 1	Framework for life cycle assessment (from ISO 14040:2006; modified) .....	1
Figure 2	ILCD Handbook approach of harmonising existing practice in line with ISO 14040 and 14044:2006.....	2
Figure 3	Main differentiation of the document for the three goal situations A, B, and C.....	10
Figure 4	The iterative nature of LCA (schematic).....	25
Figure 5	Details of the iterative approach to LCA, with focus on inventory data collection and modelling (from ISO 14044:2006, modified).....	27
Figure 6	Multifunctional process.....	73
Figure 7	Black box unit process and single operation unit process.....	75
Figure 8	Solving the multifunctionality problem by subdivision of the black box unit process.....	76
Figure 9	Solving the multifunctionality problem by substitution of the not required co-functions, schematic.....	78
Figure 10	Equivalence of additive and subtractive ("substitution") system expansion .....	79
Figure 11	Solving the multifunctionality problem by allocation of the inventory to the co-functions (illustrative).....	80
Figure 12	Cradle to grave, cradle to gate and gate to gate data sets as parts of the complete life cycle; schematic.....	96
Figure 13	Foreground system and background system in the specificity perspective (see box); (illustrative).....	99
Figure 14	Flow chart of the foreground system (schematic).....	101
Figure 15	Life cycle impact assessment (schematic).....	108
Figure 16	Limited or non-scalability of supplies in a market. The example of hydropower; illustrative.....	125
Figure 17	Part-system relationships: example of car starter battery (illustrative).....	156
Figure 18	System-system relationships: example of an electricity using product .....	158
Figure 19	Schematic and simplified supply-chain life cycle model of a product. . .....	158
Figure 20	Identifying processes within system boundary, starting from the central process or analysed system. Example of a window, illustrative.....	161
Figure 21	Decision tree for consequential modelling. Terms, concepts, and explanations see text.....	166
Figure 22	Processes averaging ("horizontal averaging", top) and systems averaging ("vertical averaging", bottom); schematic.....	249
Figure 23	Illustration of the trade-relations between countries, as basis for calculating the production, consumption and supply mixes of products.....	250



Figure 24	Quality Function Deployment (QFD) of complex products as an approach for obtaining as allocations factors the relative relevance of functions for the product users.....	264
Figure 25	The elements of the interpretation phase and their relations to other phases of the LCA and within the interpretation phase (from ISO 14044:2006, modified) .....	286
Figure 26	Focussing efforts on key data.....	298
Figure 27	The four quality aspects completeness and technological, geographical and time-related representativeness (illustrative).....	325
Figure 28	Illustration of the concepts of precision (i.e. uncertainty) and accuracy (i.e. representativeness and methodological consistency) .....	326
Figure 29	True joint process and true co-product .....	345
Figure 30	"Closed loop" recycling (schematic).. .....	347
Figure 31	"Open loop - same primary route" recycling (schematic):.....	348
Figure 32	"Open loop - different primary route" recycling. (schematic).....	349
Figure 33	Allocation of waste / end-of-life products if the management / treatment processes result in any valuable product (schematic).. .....	353
Figure 34	Recyclability substitution approach (schematic).....	357
Figure 35	System boundary diagram template for technical audience.. .....	382

## TABLES

Table 1	Key terms and definitions .....	21
Table 2	Combination of two main aspects of the decision-context: decision orientation and kind of consequences in background system or other systems. ....	38
Table 3	Most common types of LCI/LCA study deliverables required for specific LCA applications (indicative overview). ....	56
Table 4	Example for function, functional unit and reference flows in a comparative case: Outdoor wall paints comparison (illustrative) .....	64
Table 5	Overall inventory data quality (validity) and its main 6 aspects .....	329
Table 6	Quality levels and quality rating for the data quality indicators. ....	330
Table 7	Overall quality level of a data set.....	332
Table 8	Illustrative example for determining the data quality rating.....	332
Table 9	ILCD compliance of LCI and LCA studies and data sets, direct applications, and derived more specific guidance documents / Product Category Rules (PCR)..	335
Table 10	Native soil carbon stocks under native vegetation .....	338
Table 11	Land use factors .....	338
Table 12	Land management and input level factors for cropland .....	339
Table 13	Land management and input level factors for grassland .....	340

## TERMS AND CONCEPTS

Situation A ("Micro-level decision support") .....	38
Situation B ("Meso/macro-level decision support") .....	40
Situation C ("Accounting") .....	43
Function, functional unit, and reference flow .....	60
Attributional modelling .....	71
Consequential modelling .....	71
Subdivision of multifunctional processes.....	75
System expansion / substitution.....	77
Allocation.....	79
Technosphere and ecosphere – clearer defining the boundary .....	94
Foreground system and background system .....	96
Cut-off criteria.....	102
Technological representativeness of process and product .....	123
Market .....	128
“Comparison” vs. “comparative assertion disclosed to the public” .....	140
Part-system relationships including energy related products .....	155
System-system relationships.....	156
Secondary consequences .....	168
Specific, average and generic data sets .....	246
Reuse/recycling/recovery and secondary good .....	343
Recycling in ISO 14044:2006.....	344
Recyclability substitution approach .....	354

## FREQUENT ERRORS

Comparisons not based on the relevant functional unit .....	62
Using inappropriate technical standards to quantify the functional unit .....	65
Subjective or unsystematic choice of LCI modelling principles and method approaches .....	70
Incompatible LCIA methods, normalisation basis, and weighting set .....	113
Use of LCI data with another geographical scope.....	130
Misleading/wrong use of "time representativeness" .....	133
General or un-reflected exclusion of activity-types.....	162
Wrong focus of data collection .....	187
Misleading description beyond what is represented by the actual data .....	195
Un-reflected use of machine specifications .....	203
Unit conversion errors .....	203
Incomplete modelling of waste management .....	243
Insufficient methodological consistency of background data .....	247
Wrong type/reference of market value .....	265
Incomplete LCIA factor assignment to elementary flows .....	277
Inappropriate results interpretation in case of insignificant differences.....	303
Overly reliance on stochastic data uncertainty calculations .....	328
Omission or double counting/modelling of recycling .....	344

# 1 Introduction and overview

## Overview

This guide is a component of the International Reference Life Cycle Data System (ILCD) Handbook. It provides a detailed technical guidance to the ISO 14040 and 14044:2006 standards on Life Cycle Assessment (LCA).

The overall objective of the ILCD Handbook is to provide a common basis for consistent and quality-assured life cycle data and robust studies. These support coherent and reliable Sustainable Consumption and Production (SCP) policies and solid decision support in the public and private sectors related to products, resources and waste management.

## Scope of this document

This general guide provides comprehensive and detailed method provisions for Life Cycle Inventory (LCI) and Life Cycle Assessment (LCA) studies as covered by the ISO 14040 and 14044:2006 standards.

The outcome of LCI and LCA studies is the basis for all types of applications of LCA. Figure 1 shows the Life Cycle Assessment framework.

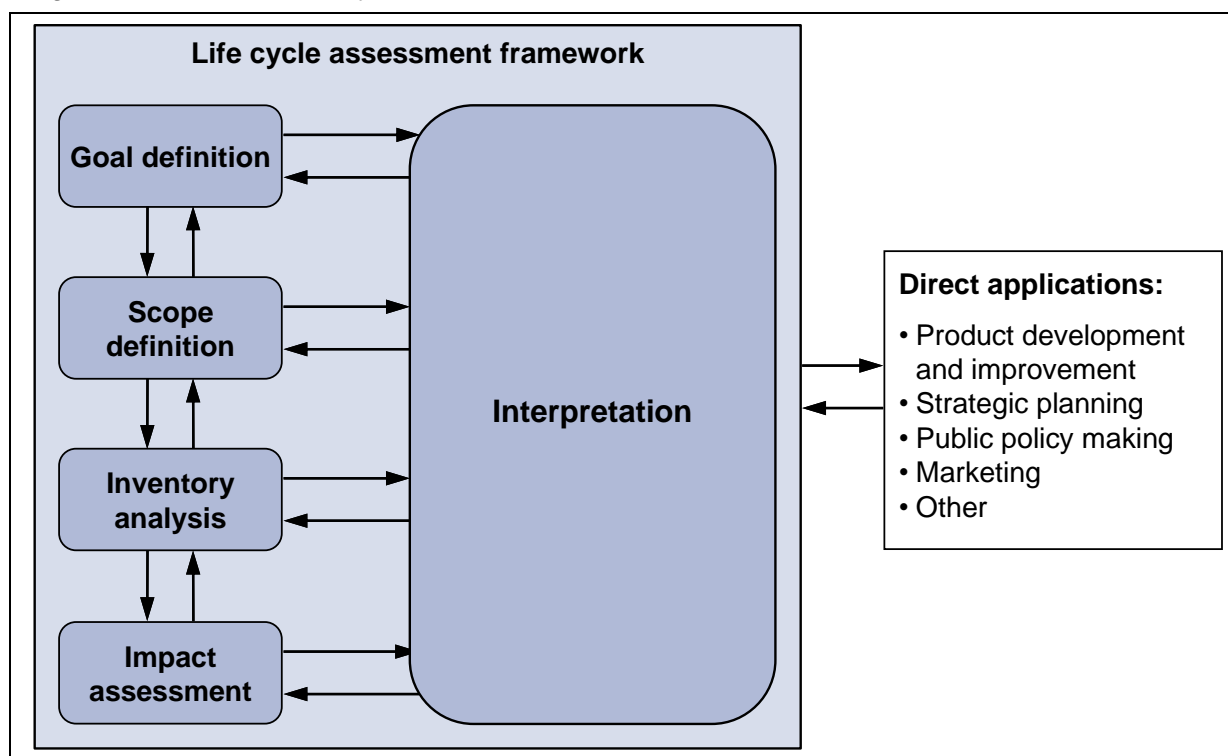

Figure 1 Framework for life cycle assessment (from ISO 14040:2006; modified)

Table 3 lists the most widely used LCA applications and their relationship to the guidance provided in this document. The subsequent use of the LCI data and LCA studies in other LCA applications is not within the scope of this document; this is analogous to ISO 14044:2006.

Since this general guidance document is applicable to a wide range of different decision-contexts and sectors, it cannot directly provide tailor-made, specific provisions, such as product-group specific guidance. It can however serve as “parent” document for specific guidance documents, such as for Product Category Rules (PCR) and other product-group specific guidance documents and for simplified yet reliable tools, such as ecodesign type tools.

Screening or streamlined Life Cycle Assessment studies are typically not compliant with ISO 14044:2006 and therefore not explicitly addressed as a separate approach in this document. They are only implicitly addressed in this document as the first iterative step of an LCA.

Purely methodological LCA studies may not be able to comply with the ILCD Handbook and the ISO 14040 and 14044:2006, since the analysed methodological options may deviate from the ILCD provisions. Such studies may draw on the ILCD Handbook, but compliance cannot be claimed and the impression shall be avoided that such would exist.

### Approach of this document and added value compared to ISO 14044

Until today, no commonly accepted guidance exists that would complement the general framework provided by ISO 14040 and 14044:2006. The ILCD has been developed to fill this gap as decision makers in government, public administration and business rely on consistent and quality-assured life cycle data and robust assessments in context of Sustainable Consumption and Production.

The relevant ISO 14040 and 14044:2006 standards, a range of Life Cycle Assessment manuals, and the general LCA literature have been analysed to identify the “needs for guidance” and to obtain input in the form of good practice approaches and arguments. Together with the extensive and detailed input and feedback received in the invited and public consultations, workshops, and other meetings, this analysis provides the evidence base for this guide. Figure 2 illustrates this approach.

The contributors and the sources consulted are documented in annex 18. An Explanatory Memorandum is separately available.

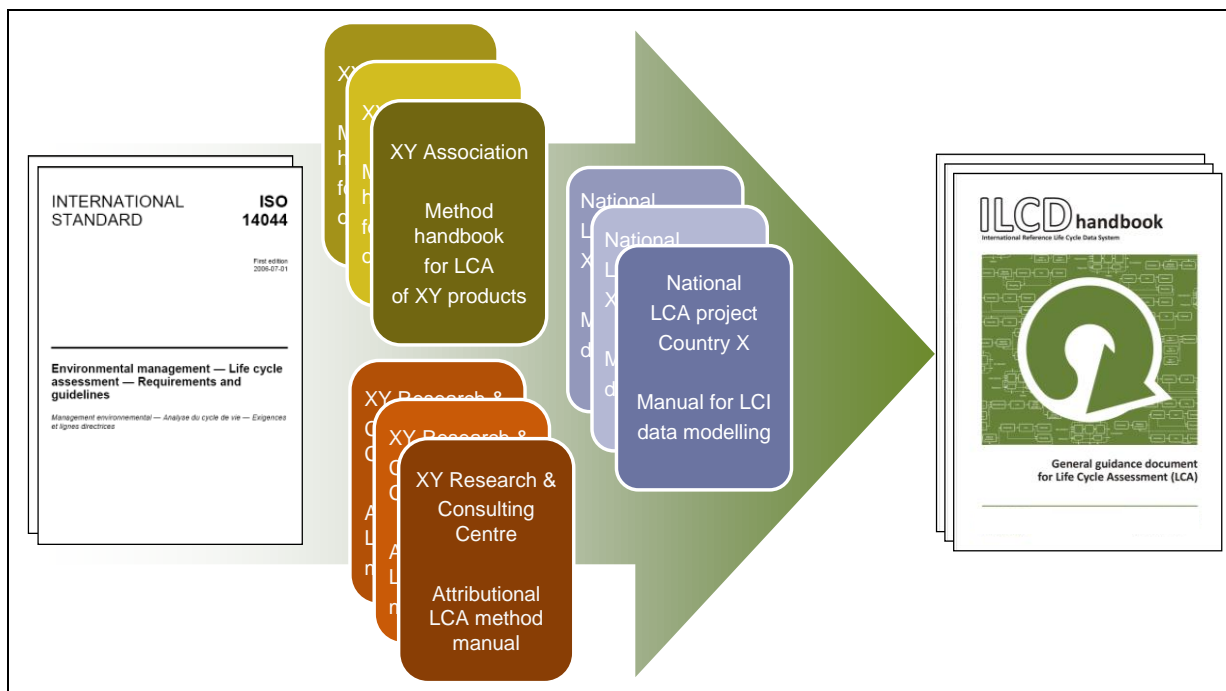

**Figure 2** ILCD Handbook approach of harmonising existing practice in line with ISO 14040 and 14044:2006

### Principles followed in developing the provisions of this document

The following principles were applied:

- **ISO compliance:** being in line with the requirements of ISO 14040 and 14044:2006

- **Best practice:** representing or building on current best practice in LCA in industry, government, research, and consultancy.
- **Reliability:** forming a reliable basis for robust life cycle based decision support, for improving reproducibility and quality of LCI studies and data sets, and for coherent, ILCD-compliant product-group specific guides and simplified approaches and tools.
- **Efficiency:** balancing theory with practicality and cost-efficiency.
- **Flexibility:** permitting exceptions of provisions as and where needed for different questions addressed with LCA and for different processes, products and other systems that are analysed. Deviations need to be documented and explicitly be considered in the results interpretation.
- **Fairness and acceptance:** providing a level playing field across competing products, processes and industries. Exceptions must not relatively disfavour competitors. The role of interested parties and of review is strengthened for achieving broad stakeholder acceptance. Protecting confidential and proprietary information in confidential reports that are available exclusively to the critical reviewers.
- **Transparency and reproducibility:** request comprehensive documentation and mechanisms that allow reviewers to verify/review all data, calculations, and assumptions.
- **Assured quality:** require qualified and independent and/or external review as indicated by the type of study and target audience (detailed provisions given in separate document)

### Differentiated guidance for main goal situations encountered in LCA practice

Building on the state-of-the-art analysis of best practice, this document has been developed to provide comprehensive and generally applicable yet practical guidance. This involves adding substantial detail and further specifying and clarifying the ISO provisions from the perspective of the three main goal situations encountered in LCA studies:

- **Situation A ("Micro-level decision support"):** Decision support on micro-level, typically for product-related questions. "Micro-level decisions" are assumed to have only limited and no structural consequences outside the decision-context, i.e. do not change available production capacity. The effects are too small to overcome the threshold to be able to cause so called large-scale consequences in the background system or other parts of the technosphere
- **Situation B ("Meso/macro-level decision support"):** Decision support at a strategic level (e.g. raw materials strategies, technology scenarios, policy options, etc). "Meso/macro-level decisions" are assumed to have also structural consequences outside the decision-context, i.e. they do change available production capacity. The analysed decision alone results in large-scale consequences in the background system or other parts of the technosphere
- **Situation C ("Accounting"):** Purely descriptive documentation of the system under analysis (e.g. a product, sector or country), without being interested in any potential consequences on other parts of the economy. Situation C has two sub-types: **Situation C1** that includes existing benefits outside the analysed system (e.g. credits existing recycling benefits) and **Situation C2** that does not do so.

## Main methodological issues addressed in this document

The key issues in LCA within the scope of ISO14044:2006 and hence of this document are generally understood to be the questions:

- **Which LCI modelling principle to follow** (i.e. attributional or consequential)?
- **Which LCI method approaches to employ for solving multifunctionality** of processes (i.e. allocation or system expansion/substitution)?

These issues are those where the three goal situations differ most in terms of LCI method provisions.

In addition, the following main issues need guidance and are hence addressed in detail:

- **System boundaries:** the definition and application of system boundaries and of quantitative cut-off criteria (including the question which kind of activities to include in LCA);
- **Avoiding misleading LCA studies:** how to avoid misleading goal and scope definition, results interpretation, and reporting (what relates to a number of more specific issues);
- **Transparency:** how to meet the principle of transparency in the context of potentially sensitive or proprietary process data and information;
- **Reproducibility and robustness:** how to improve reproducibility in data collection and modelling and the documentation of LCI data sets, and the robustness of conclusions and recommendations of LCA studies;
- **Primary and secondary data:** when to use primary data and when secondary data can be used (and what is a suitable concept for the foreground and the background system);
- **Quality:** how to capture the various quality aspects of LCI data and of LCA results.

## Further topics in focus

Product group and sector specific guidance is outside the scope of this document and will need product-group specific guides to be developed. However, for certain types of processes the application of LCA is less straightforward and divergent approaches have been developed in practice. These types are mainly agricultural and similar processes, waste deposition, the use stage of consumer products, and services (as opposed to goods). The first two are addressed in own chapters. The use stage of consumer products is covered as a smaller sub-chapter. Services are generally addressed throughout the document, explicitly or in examples; however, more guidance is seen beneficial for services.

One of the methodologically more difficult topics is often understood to be the modelling of reuse, recycling and recovery of secondary goods from end-of-life products and production waste. While methodologically these are all cases of multifunctionality, this topic has a longer dedicated chapter in the annex.

"Time in LCA", finally, is one of the topics that recently gain more attention with various approaches emerging in LCA practice. Issues such as long-term emissions, temporary and permanent carbon storage, and delayed emissions of greenhouse gases are hence addressed in some detail.



## 2 How to use this document

### 2.1 Structure of the document

#### Building on scope and structure of ISO 14044

This document follows the main structure of ISO 14044:2006. In the ILCD Handbook, the five main phases of Life Cycle Assessment (goal definition, scope definition, inventory analysis, impact assessment, and interpretation) each have their own chapter<sup>1</sup>; see Figure 1. As in ISO 14044:2006, additional principal chapters address reporting and critical review.

A number of issues that are not addressed in ISO 14044:2006 - or to only a limited extent - have been added or expanded on, typically in the form of individual chapters, such as on the selection of the appropriate LCI modelling frame. A few key issues that are addressed as parts of several chapters throughout ISO 14044:2006, such as on the iterative nature of LCA and how it best implemented, have been combined into individual chapters.

Several key concepts of LCA are explored in more detail, especially where different meanings or terms are used. Frequently made errors in LCA practice are identified within the respective chapters, to help avoid and overcoming them.

The special relevance of the scope definition phase of a LCI or LCA study is often neglected in today's practice. In the scope phase, crucial decisions are made for the entire LCI or LCA study; these are derived from the goal definitions. These decisions include the already named identification of the LCI modelling frame, the selection of Life Cycle Impact Assessment (LCIA) methods and - if included - the normalisation basis and weighting set, as well as identifying review and reporting requirements. Actual LCI data collection and modelling are then addressed in the LCI phase. The LCIA phase serves to calculate LCIA results and - if included - normalised and weighted results.

Compared to ISO 14044:2006, the structure of this guidance document has been adjusted to better reflect the workflow steps when performing an LCA. References to the corresponding chapter in the ISO 14044:2006 standard are given in each chapter.

#### Formatting elements

Five formatting elements have been used throughout the document to address different aspects:

**Main text body:** gives the detailed explanations to the guidance. The brief in-line examples are set in a grey font so as to minimise the disturbance of the reading flow.

#### 6.7.3 Geographical representativeness

(Refers to aspect of ISO 14044:2006 chapter 4.2.3.6.2)

##### Introduction

The geographical representativeness of a process or system identifies how well the inventory data represents it regarding the location (e.g. market, site(s), region, country, etc.) that is documented in the descriptive information of the data set or report and where it is operated, produced, or consumed.

##### Identifying the appropriate geographical scope of LCI data

The level and type of technology that is applied, and the conditions under which it runs (e.g. in terms of surrounding climate or national legal requirements on emission limits), are influenced by the geographical location of the process. Also to identify the mix of marginal processes (for consequential modelling) and the background data (for both attributional and consequential modelling) a correct identification of the geographical scope is required.

<sup>1</sup> ISO 14044 joins goal and scope into one phase. It is argued here to better reflect the different nature and purpose of these two steps to treat them as separate phases. In addition to the resulting five phases, also reporting and review could be considered own phases; while this is not done here, they have own main chapters.

Provisions: 5.2 Six aspects of the goal definition	
I)	SHALL - <b>Intended applications:</b> Identify the intended applications of the deliverable of the LCI or LCA study (5.2.1).
II)	SHALL - <b>Limitations:</b> Identify and detail any initially set limitations for the use of the LCI/LCA study due to (5.2.2):
II.a)	<b>Impact coverage limitations</b> such as in Carbon footprint calculations.
II.b)	<b>Methodological limitations</b> of LCA in general or of specific method approaches applied, and/or
II.c)	<b>Assumption limitations:</b> Specific or uncommon assumptions / scenarios modelled for the analysed system. (ISO+)

**Provisions:** Set within a dashed-dotted green border, the "Provisions" outline the provisions for ILCD-compliant studies, as comprehensive yet concise checklists for daily reference. The combined "Provisions" are also available as a separate document.

**Terms and concepts:** In highlighted blue boxes, the more complex terms and concepts of often diverging use in LCA practice are explained and illustrated; often supported with graphics.

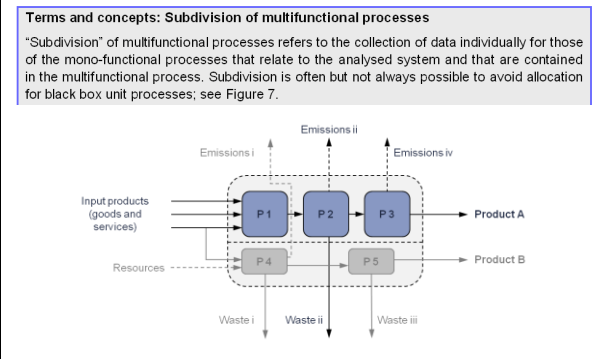

**Frequent errors: General or un-reflected exclusion of activity-types**

As already addressed in chapter 6.5.2, in LCA practice it can still often be found that certain types of activities that should be attributed to the analysed system are omitted without sufficient justification. Among these processes, services and investment goods are the most common ones. While it might be justified to e.g. ignore the construction and demolishing of the power plant itself when modelling electricity production (depending on the cut-off criteria set), the limited relevance of investment goods certainly does not apply in general. Similarly, are many services in many cases of no quantitative relevance, but also this can clearly not be generalised. A good example is the wind-power plant, where the plant production and maintenance obviously makes up the vast majority of impacts.

**Frequent errors:** Frequently made errors in LCA practice are addressed in highlighted purple boxes, to help avoiding and overcoming them.

**Annexes:** The annexes provide detail on broader issues that are relevant but which would disturb the reading flow if kept within the main text. Annexes are provided e.g. on the data quality concept of the ILCD, modelling of waste & end-of-life product reuse, recycling and energy recovery, and on how to avoid misleading LCA studies.

### Related topics addressed in other ILCD Handbook components

A number of nomenclature and other conventions help to improve compatibility of data sets developed throughout this document, and aid an understanding of LCA study reports developed by different experts. (Further detail is provided in the separate document "Nomenclature and other conventions").

An electronic LCA report template supports effective and compatible reporting of LCA studies. The electronic LCI data set format supports effective and compatible reporting of LCI data sets. It is supported by a data set editor application and a complete set of reference elementary flows, flow properties and units. Both the report template and the data set format are referenced from chapters 6.12 and 10.

Guidance for developers of Life Cycle Impact Assessment (LCIA) models, methods and indicators is given in the separate document "Framework and requirements for Life Cycle Impact Assessment (LCIA) models and indicators". In this guide, chapter 6.7 points to that document. This topic is supported by the background document "Analysis of existing Environmental Impact Assessment methodologies for use in Life Cycle Assessment (LCA)".

The detailed provisions for reviewing LCI and LCA studies and data sets are given in the separate guidance documents on "Review schemes for Life Cycle Assessment (LCA)",

"Reviewer qualification", and "Review scope, methods, and documentation". In this document, chapters 6.11 and 11 refer to these documents.

### **General applicability of guidance**

The deliverables of an LCA can range in complexity and extent from a single operation unit process to a comparative assertion of two or more products or strategies (for a complete list see chapter 6.3). A number of provisions apply only to the more complex deliverables, while they are inapplicable to the more basic deliverables. This is highlighted at the beginning of the respective "Provisions". However, this general guide needs to be applicable (as with ISO 14044) for a wide range of deliverables, for different study objects (e.g. process step, product, country, etc.), and for a huge variety of questions addressed in the study. This makes it unavoidable to formulate the provisions in a fairly generic manner. It would be impractical to approach all the specific kinds of cases specifically. For key types of deliverables, however, specific guidance documents are seen as beneficial. Such a separate document is provided for the "Development of Life Cycle Inventory (LCI) data sets".

### **LCA as an iterative process**

The work on an LCA is a systematic process, which involves iterations: Some issues cannot be addressed initially, or only touched on. However, they will be addressed, improved, or revised in the typically 2 to 3 iterations of almost any LCI or LCA study. Chapter 4 has more on this. To ease the workflow, it is generally explicitly stated in the "Provisions" what should be done in the initial round and what in the later iterations. The iterations thereby draw on steps that have been performed earlier in the study. For example, the iteration of collecting better data draws on the identification of significant issues carried out in the preceding iteration based on the preceding LCI model. However, the respective provisions e.g. on identification of significant issues are necessarily found later in the document. The need to understand and consider later steps when performing the preceding steps can make it difficult for less experienced practitioners to find an efficient way to perform an LCA study. Therefore, cross-references are put in many cases.

## **2.2 How to work with this document**

### **2.2.1 Overview**

The concept of this document is to help practitioners to conduct LCI and LCA studies in line with the three main goal situations that are encountered in LCA practice.

This chapter aims to support an efficient and effective workflow and focuses on those steps that are needed for a given study. It provides "guidance to the guide", by giving an overview of the key provisions, informing which parts of the document differ among the three archetypal goal situations, and explains how to efficiently work through the "Provisions".

To enable easier identification of the chapters required for a given case, notes at the beginning of the respective "Provisions" and cross-references are put.

### **2.2.2 Theoretical approaches and simplifications**

In most cases, it is quite straightforward to develop an ILCD compliant LCI data set or LCA study using this document.

This is because some simplifications are put in place that avoid the need for applying some of the more complicated procedures, such as those for identifying processes in consequential modelling including secondary consequences and market constraints. These

slightly simplified provisions substantially reduce the effort, while not relevantly harming the accuracy or robustness of the results. They even further increase the general reproducibility and better reflect established practice in industry.

These simplifications draw on the detailed and differentiated method provisions that are therefore necessary and that are to be fully applied in a few cases. For these cases they are essential; hence the detailed provisions need to be kept as well.

Most aspects of doing an LCA are the same for all goal Situations. Among these aspects are those that are always to be followed or checked. Conversely there are some, often very specific aspects that apply in only few cases. As an LCA may include many processes, some of the specific provisions are typically required for each study, but only for selected processes.

It is also noted that the unit process inventories are basically the same for all Situations, while some specific, additional information is required when using them in the context of the specific 'Situation' (e.g. on the amount of products involved and the size of the respective market). The main difference between Situation A, B and C lies hence in the selection of the processes that are included in the system boundary and how the life cycle is modelled by connecting them.

## 2.2.3 Overview of differences in the provisions for the Situations A, B, and C

### Overview

This chapter provides a very condensed orientation of the differences in the provisions that apply to the three goal Situations A, B, and C.

The overview graphic of Figure 3 identifies the chapters which have substantially different provisions for the individual goal situations A, B, and C. Note that a few other chapters that apply to all situations have single aspects that are differentiated for the three goal situations.

The detailed method provisions for the differentiated archetypal goal situations A, B, and C as well as explanations and illustrations are given in the respective chapters.

### Orientation for experts: the differentiated LCI modelling provisions for Situations A, B, and C

The main differences between the archetypal goal Situations A, B, and C lie in the LCI modelling. In a condensed form for overview, this document makes the following specific provisions. Effectively, there are only a few but very relevant and necessary differences in which the provisions for these Situations differ. (NB: If you are not familiar with the used terms and concepts, please see the later chapters):

**Situation A:** This comprises micro-level, product or process-related decision support studies. The life cycle is modelled by depicting the existing supply-chain, i.e. attributionally. The foreground system should aim at using primary data from the producer / operator and secondary data from suppliers and downstream users/customers. Background processes should represent the average market consumption mix. Generic data from third-party data providers can be used for the background system. They can also be used for the foreground system if they are of better overall quality for the given case than available primary or secondary data from direct suppliers or downstream operators. Cases of general multifunctionality, of recycling, and of reuse and recovery are preferably solved via subdivision or virtual subdivision. If this is not possible or feasible, then a substitution of the market mix of the not required co-functions should be performed as second alternative

(excluding the substituted co-function from this mix). If also this is not possible or feasible, then allocation is the third, alternative solution. Detailed guidance is given for these three options. If the second or third alternative is used, the resulting lack in accuracy shall be explicitly reported and considered in the results interpretation. "Assumption scenarios" of data, parameters, and method assumptions shall be performed for comparative LCA studies; exclusively the "shall" provisions cannot be rejected in these scenarios. Uncertainty calculation can support the analysis of the robustness of the results.

**Situation B:** This comprises meso-level and macro-level, strategic ("policy") decision support studies. The analysed systems shall be modelled as in Situation A, except for those processes in the background system that are affected by large-scale consequences of the analysed decision. These are modelled with the mix of the long-term marginal processes / systems. Contrary to Situation A, the assumption scenarios can also vary the "shall" provisions; the assumption scenarios and uncertainty calculation shall be defined via a best attainable consensus among the interested parties.

**Situation C:** Most monitoring type studies fall into Situation C1; Situation C2 studies are less common. For Situation C1, the life cycle and all cases of multifunctionality are modelled as in Situation A. In contrast to Situation A, this also applies to macro-level monitoring studies under Situation C1, i.e. independent from the absolute size of the system (e.g. 1 t or 1 Mio t material X consumed). This means that the data and models of studies performed under Situation A can be directly used for deriving monitoring indicators under Situation C1. For Situation C2, the life cycle is equally modelled as in Situation A, but multifunctionality shall always be solved via allocation, through application of the detailed allocation guidance provided.

Note that across all goal Situations the same life cycle model can chiefly be used, except for cases of multifunctionality that need to be switched between substitution and allocation, depending on the applicable Situation. Additionally, the very few processes that are typically affected by large-scale consequences under Situation B, need to be modelled differently: These processes need to be the long-term marginal mixes (note that for these processes the upstream or downstream life cycles will be different as well).

### **Other differences in the guidance for Situations A, B, and C**

A few more differences exist in the provisions for Situations A, B, and C. The more relevance ones are:

The general **critical review** requirements of ISO 14040 and 14044 are specified in the separate documents "Review schemes for Life Cycle Assessment (LCA)", "Reviewer qualification", and "Review scope, methods and documentation". This includes the provisions on the applicable type of review for different types of studies and audiences, on the qualification of the reviewer, and regarding what and how to review.

Finally, as another key item of further specification, the ISO 14044 provisions for "**comparative assertions** disclosed to the public" are extended also to most non-assertive but comparative LCA studies.

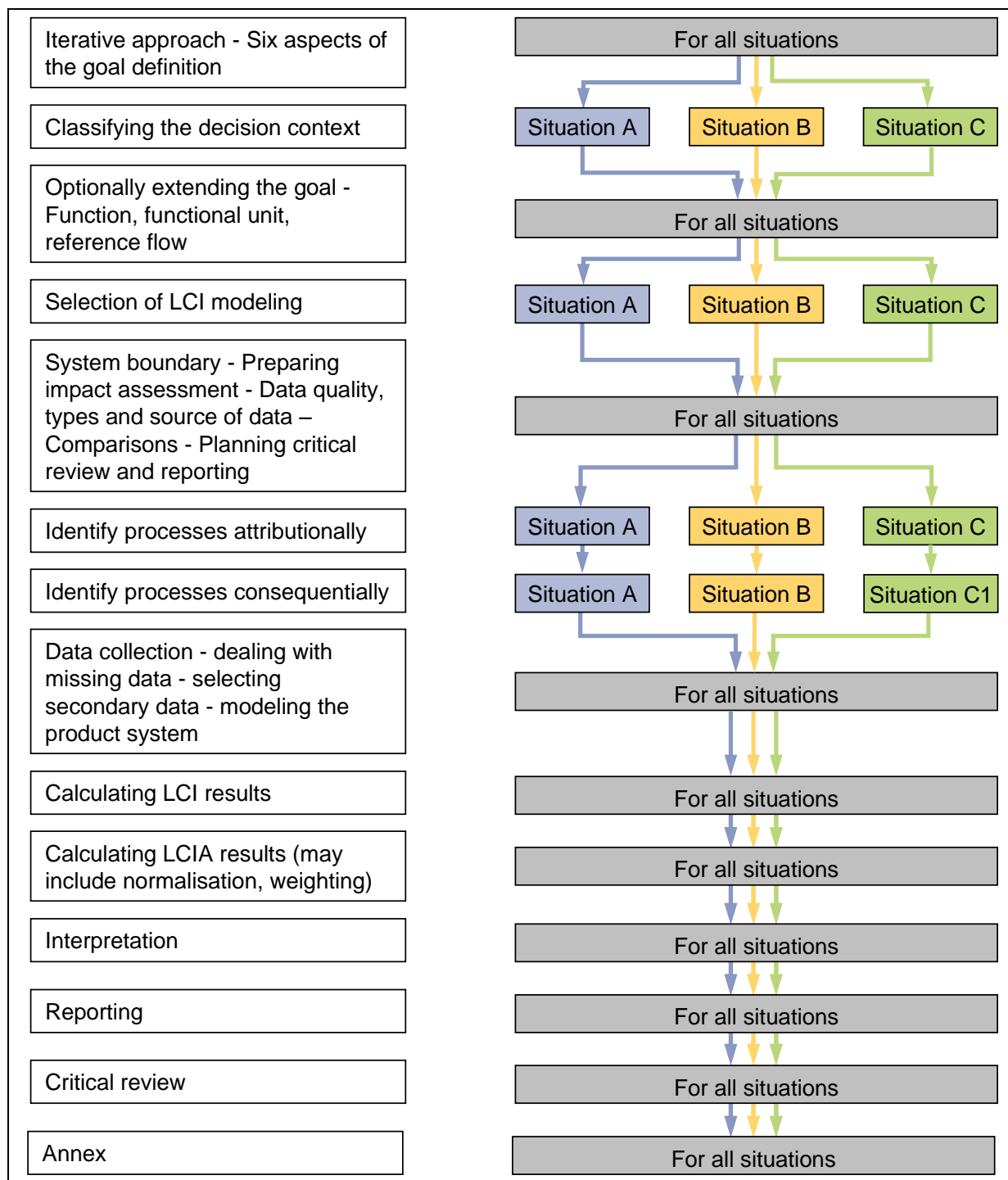

**Figure 3 Main differentiation of the document for the three goal situations A, B, and C (indicative only; few other differences exist).**

### 2.2.4 How to perform an LCI or LCA study in accordance with this document

The structure of this guide generally orients to the workflow encountered in LCA. It cannot do this however in a strict sense without jumping forth and back in the formal logic of the phases of an LCA. The fact that performing an LCA studies is an iterative process, poses an additional challenge to a workflow-based structure.

The following steps take this into account and recommend a way to efficiently perform an LCI or LCA study in line with this document and with the general frame of ISO 14044:

- **This chapter:** Read the "Provisions" of this chapter; they inform you about the specific character of the provisions in the "Provisions" of this document and how they relate to ILCD compliant studies.
- **LCAs are iterative:** Unless you are fully familiar with this, read chapter 4 on the iterative nature of LCA. It has two graphics that illustrate the steps that are described in more detail here.
- **Prepare for documentation:** Prepare to document all relevant steps taken, decisions and assumptions made, data sources used, calculations performed, etc. This is a valuable basis for correct and efficient reporting. While it is the last step of an LCI or LCA study before a critical review (if foreseen), reporting actually starts from the very beginning of the process. Reporting is supported here with a template for LCI and LCA study reports, and a data set format for LCI data sets; these are available as files and a supporting editor tool.
- **Goal definition, key aspects:** Define the following of the goal aspects of your study: the decision context, the intended applications, and the intended audience (chapters 5.2.1, 5.2.3, and 5.2.4).
- **Scope definition - study object:** Unless you have defined the study object explicitly in the goal definition, identify it now as closely as possible (e.g. a specific branded product or a commodity, a processing step, a policy option, etc.) and specify what its function is in the sense of LCA (if unclear, see chapter 6.4 and related box on "Function, functional unit, and reference flow").
- **Scope definition - classify applicable goal situation A, B, or C:** Check in Table 3 to which archetypal goal Situation A, B, C1 or C2 your study belongs. If in doubt, chapter 5.3 provides the detailed guidance and explains what each class A, B, C1, and C2 implies. Also in Table 3, check which types of deliverable the LCA study can typically have for your intended application, unless you already have decided that in the goal definition.
- **Complete initial round of goal definition:** With this information at hand, perform the outstanding steps of the goal phase. This means to carry out all of the following:
  - Identify **pre-set limitations due to method choices, assumptions, or impact coverage** (e.g. Carbon footprint studies) (chapter 5.2.2)
  - Name the **reasons for carrying out the study** (chapter 5.2.3)
  - Clarify whether the **study involves comparisons** and whether they are intended to be **disclosed to the public** (chapter 5.2.5)
  - Identify the **commissioner and other potentially influential actors** that are actively involved in the study (chapter 5.2.6)
- **Complete the initial round of scope definition:** In line with the detailed goal definition, perform the outstanding steps of the scope phase. Note that many chapters of the scope phase give provisions that will be applied only in the later Life Cycle Inventory phase, and hence are defining requirements without direct need for action at that point. It is however recommended to obtain a general understanding of what is required, also because it affects some subsequent scope definition steps. What now needs to be actively carried out in the scope phase is:

- **Detail functional unit and reference flow;** chapter 6.4: Detail quantitatively and qualitatively the study object(s)' functional unit(s) and/or reference flow(s) (and provide technical specifications etc., as required for the type of study object). This information will later typically be revised to some extent.
- **Define system boundary;** chapters 6.6 and especially 6.6.2: Provide an initial system boundary definition and a list of potentially excluded life cycle stages, activity types, processes, and elementary flow, if any. This initial setting will later typically be extensively revised. Note that at this stage no individual processes will be identified; this is the first step of the later Life Cycle Inventory work.
- **Define cut-off;** chapter 6.6.3: Define the quantitative cut-off criteria that are aimed at, unless this has been defined already in the goal definition. This initial aim will later typically be extensively revised if the study is comparative. If the targeted completeness cannot be met due to limited access to data or lack of resources, it will later be revised to some extent. Note that the latter can mean in few cases that the general goal of the study cannot be achieved and that it needs to be revised.
- **Prepare basis for LCIA;** chapter 6.7: Identify the impact categories to be included, the LCIA methods to be used, the impact level that will be analysed, and whether normalisation and weighting will be used for either cut-off and/or in support of the results interpretation. This decision must not be fundamentally revised later. However - based on the outcome of the next iterations - irrelevant impact categories can be excluded, new ones outside the default list may need to be added, the modification to location non-generic LCIA methods may be necessary, and the normalisation basis and weighting set may see some adjustments in relation to the before-mentioned adjustments.
- **Derive data quality needs;** chapter 6.9: Define the other data quality needs apart from the cut-off criteria, i.e. the study related data accuracy and precision that is intended, as far as initially possible. Similarly as for the initial cut-off settings, this will later see more substantial revision if the study is comparative. Finally, if the inventory data quality cannot be met due to lack of access to data or lack of resources, some revisions will typically need to be made.
- **Shortlist information sources;** also within chapter 6.9: Principle data and information sources may now be shortlisted. This can alternatively be carried out in the later step of planning data collection (chapter 7.3).
- **Plan reporting;** chapter 6.12: Plan the reporting, depending on the type of study and deliverable, as well as the intended audience.
- **Plan review;** chapter 6.11: Identify, which review type applies and preferably already who is/are the reviewer(s). Both depend on the type of study and target audience. Note that for Situation B it is required to involve the interested parties in some initial steps of the study.
- **Life Cycle Inventory work:** The main part of an LCA is generally the inventory work, regarding both duration and resources used:
  - **Identify processes within system boundary:** As first step of the LCI phase and depending on the applicable Goal Situation, identify the to-be-included processes within your system boundaries. Note that the step relates to the processes of the foreground system only, and to the product and waste flows that connect foreground and background system. Chapter 7.2.3 gives the provisions for all Situations, except



for those processes in Situation B that are affected by large-scale consequences and for assumption scenarios under Situation B, if these include full consequential modelling elements. Chapter 7.2.4 gives the provisions for this specific purpose. For identifying the to-be-included processes, it is recommended to draw on existing experience only of detailed, high quality studies on sufficiently similar study objects, or ILCD-compliant product-group specific guides or Product category Rules (PCRs).

- **Perform a screening LCA:** If the to-be-included processes have been identified, initially it is recommended to perform a screening LCA: A first, rough life cycle inventory system model, its impact assessment calculation, and analysis helps in identifying these "key" processes, parameters, elementary flows, assumptions, LCIA characterisation factors, etc. that largely contribute to or influence the environmental impacts of the analysed process or system. This will then help in an iterative way to achieve the minimum required data quality with minimum necessary effort. In more detail, a screening LCA comprises the following steps:
  - **Compile initially available LCI data:** Supplement any initially available specific foreground data with secondary data, preferably from the suppliers and/or downstream users, as applicable. These can be raw data, unit processes, LCI results, and similar. The provisions for developing new unit processes see chapter 7.4.2. Alternative sources for foreground data for a first screening model can be third-party data provider with sufficiently representative, methodologically consistent, generic or average background data sets. For initially missing data use expert judgement to estimate reasonably worst-case data (see chapters 7.6 and 7.8). A number of specific requirements on data, inventorying, nomenclature, etc., are provided in the various subchapters of 7.4.3 and in chapter 7.4.5. Specific provisions for the cases of agricultural systems and waste management are supplied in chapter 7.4.4. It is recommended to accompany all the LCI steps with an interim quality control that generally draws on the elements of the interpretation phase while without going into the same level of detail (chapter 7.4.2.11).
  - **Develop initial life cycle model:** Next, model the life cycle of the analysed system (chapter 7.8). Specific and detailed provisions on the modelling of specific kinds of systems, how to solve multifunctionality, etc., are given in the subchapters of 7.9, but note the simplified requirements for solving multifunctionality given in chapter 6.5.4. Details for modelling reuse, recycling and recovery are given in annex 14; also for these simplifications apply. Note that this step is also required if the deliverable of the LCI study is a unit process, as its achieved quality (i.e. completeness, accuracy, and precision) needs to be judged from the system's perspective. The focus and principal effort should of course be placed on the analysed unit process.
  - **Calculate initial LCI results:** Next, perform a first calculation of the LCI results (see chapter 7.10) of this initial, rough life cycle model.
  - **Calculate initial LCIA results:** Then, calculate the initial LCIA results (potentially including normalisation and weighting) (chapter 8).
  - **Significant issues:** As a first step of the interpretation phase, identify the significant issues, i.e. the key processes, parameters, elementary flows, assumptions, etc. with the largest contributions / relevance for the overall environmental impacts, or individually for each impact category (chapter 9.2).

- **Sensitivity, completeness, consistency check:** Finally, perform an initial sensitivity check (chapter 9.3.3), completeness check (chapter 9.3.2) and consistency check (chapter 9.3.4).
- **Go to the second iteration:** Use the insights of the interpretation / quality checks to increase the overall quality of the LCI model. This is done in iterative loops of scope, inventory, impact assessment, and interpretation / quality control until the accuracy, precision, and completeness of the LCI / LCA study meet the requirements posed by the intended application of the results. Note that the insights gained in an iteration may also lead to a necessary revision of the goal of a study, if for example data limitations cannot be overcome. Especially:
  - **Goal and scope revision needed?:** Check whether the goal requirements can still be met and whether the scope settings still fully apply. If necessary, refine or revise them (see chapter 6). A key step is to adjust the initial system boundary (see chapter 6.6), identifying which co-functions have been excluded from or have later been added within the system boundary via system expansion / substitution or allocation (see chapters 7.2.4.6 or 7.9, respectively)<sup>2</sup>. Also other scope items may need revision, as indicated above.
  - **Improve key LCI data:** For the key processes, parameters and elementary flows introduce or improve the foreground system typically with directly collected or calculated product- and producer-specific primary and secondary LCI data (see chapter 7.4). Use more accurate, precise and complete generic or average data sets for the background system (see chapters 7.5, 7.6, and 7.7)<sup>3</sup>. Be prepared that it may be necessary to collect study-specific LCI data also for key processes in the background system, if existing third-party data is not of sufficient quality or consistency.
  - **Improve other LCI data:** Improve the quality of the LCI data for those life cycle stages, activity types, processes or elementary flows, which in the initial system boundary setting were assumed to be of little significance, but which the sensitivity analysis has revealed to be relevant. Use sufficiently consistent LCI data of sufficient quality in accordance with the cut-off criteria established in the scope definition and – in the case of comparisons - the extent of the differences between the compared systems. Where sufficiently good data are not available, leave out the respective processes and flows entirely and document the gap (see 7.4.2.11).
  - **Improve method and assumption related data and information:** Improve the quality of the data and information used for method settings and assumptions, such as allocation criteria, type and amount of superseded processes from recycling, identified long-term marginal processes for Situation B, etc.
  - **Improve LCIA factors:** Improve the quality of key LCIA characterisation factors, if feasible. The need may arise to use non-generic LCIA factors or to consider the reduced accuracy if the former would be required but be unavailable.

---

<sup>2</sup> Ensure that any scope revision is still in line with the goal. Note that for comparative studies, limitations due to scope or goal items are to be explicitly considered in the interpretation phase, especially when drawing conclusions and giving recommendations (see chapter 6.10.4).

<sup>3</sup> Note that sometimes generic or average data can be more appropriate for specific foreground processes (see chapter 7.3.2).

- **Calculate LCIA results and perform again a completeness, sensitivity and consistency check:** Calculate the improved LCIA results, check whether the significant issues have relevantly changed and perform again a completeness, sensitivity and consistency check as the basis for the third iteration.
- **More iterations needed?:** Typically, expect in total two to four iterations towards completing the study. This number will mainly depend on the quality needs or ambition, the complexity of the analysed process(es) or system(s), on the specifically analysed question(s), as well as on data availability and quality. If another iteration is needed, start again with checking whether goal requirements can still be met, whether the scope settings need to be revised or fine-tuned, etc.
- **Results interpretation:** If the LCI data and model have reached the intended or required quality, formal results interpretation is the next step (chapter 9). At this stage and only for LCA studies, it also includes the steps of conclusions and potentially recommendations, highlighting any limitations that apply. Parts of it - namely identifying significant issues and performing / reporting on the sensitivity check, completeness check, and consistency check - can also be applied to LCI data sets and studies.
- **Reporting:** As a final step prior to a potential critical review, the study report is prepared (chapter 10). It can be part of a data set and/or be a classical report. Both will base on the extensive notes that were taken and revised / adjusted along the iterations of the LCA work. The principles of reporting are reproducibility and transparency. Confidential and proprietary data and information should be documented in separate confidential reports that are made accessible only to the critical reviewer(s). For LCA studies, a third-party study report is required if the target audience is external (see chapter 10.3.2). For LCI data sets, an LCI study report is recommended. If the data are intended to be usable in support of comparisons (e.g. as background data sets), the documentation of the LCI data set should to meet the requirements for reporting of comparative assertions; otherwise the data has to be revisited to complete the documentation when the data is used in the comparison, what often will not be possible (for details see 10.3.3).
- **Review:** A critical review - if required for your type of LCI / LCA study and target audience, or for general quality-assurance reasons - is the last formal step of an LCI or LCA study (chapter 11). The review type and reviewer(s) now have to be fixed, unless this has been done in the related scope chapter.
- **Need for corrections / improvements based on the review outcome?:** The review itself will often lead to certain corrections in the LCI model or other aspects as well as the related reporting. It might even result in a more fundamental revision of the scope or even goal of the study. A review that is performed at the end of a study can hence result in considerable delays and extra work. An accompanying review can help avoiding such problems or at least identify them earlier.
- **Mission completed:** The revised final deliverable of the LCI or LCA study, potentially together with the study report and review report, is finally available to be distributed to the target audience and in support of the intended applications.

## 2.3 ILCD compliance and the "Provisions" within this document

### Overview

The actual provisions and recommendations of this guide are given in the "Provisions" of this document, with some provisions being outlined in separate, referenced documents of the ILCD Handbook (e.g. on review). Relevant concepts, explanations and illustrative examples are also provided in the main text; they may be required for a clear understanding of terms and concepts used in the respective Provision.

### Compliance statements

Life Cycle Inventory and Assessment studies as well as direct applications that have been developed in line with the provisions of this document can be published as "ILCD Handbook compliant" studies / documents.

Specific LCI / LCA guidance documents (e.g. product-group specific guides) and Product Category Rules (PCR) can claim ILCD compliance if their provisions are in line with the provisions of the ILCD Handbook and they have undergone an ILCD compliant review as specified in the separate document "Review schemes for LCA".

The compliance statement shall refer to the applicable Situation A, B, C1, and/or C2. ILCD compliance is structured into five compliance aspects that all shall be met for full compliance: Data quality, Method, Nomenclature, Review, and Documentation (chapter 12.4 gives the details).

Partial compliance can be claimed in a structured way by referring to any of the above five aspects, but it shall be clearly communicated in such cases that full compliance has not been achieved.

Purely methodological LCA studies may not be able to comply with the ILCD Handbook and the ISO 14040 and 14044, as the analysed methodological options may deviate from the provisions. Such studies may draw on the ILCD provisions, but compliance with the ILCD Handbook cannot be claimed in such cases, and giving any false impression that such would exist shall be avoided that such would exist. However, partial compliance (see above) can be reported.

In addition, for LCI data sets, the achieved overall data quality level should be documented in the data set (see chapter 12.3 for details) as well as the performed review type and reviewer(s).

When claiming compliance, the applied version or edition of the ILCD "General guide for LCA" shall be identified in connection to the claim. When a new version of an ILCD Handbook component has been published, the provisions of that new version shall be applied, overruling the ones of the former version. The provisions of the preceding version can per default still be applied for ongoing studies up to a maximum of 6 months after publication of the new version. These 6 months can be modified and overruled by different provisions of ILCD system operators. If a new version of any applicable ILCD component has been published but an older version is used, the name of the component and the publication date of the new version shall be clearly identified in the study or other deliverable that claims compliance.

### Provisions

To ease developing ILCD compliant studies, all "Provisions" are marked as either "shall", "should" or "may" to identify the provision's requirement status:

- "SHALL": the provision is a mandatory requirement and must always be followed, unless for specifically named exceptions, if any.
- "SHOULD": the provision must be followed but deviations are permissible only if, for the given case, they are clearly justified in writing, giving appropriate details. Reasons for deviations can be that the respective provision or parts of it are not applicable, or if another solution is clearly more appropriate. If the permissible deviations and justifications are restricted, then these are identified in the context of the provision.
- "MAY": the provision is only a methodological or procedural recommendation. The provision can be ignored or the issue can be addressed in another way without the need for any justification or explanation. NOTE: Instead of "may" the term "recommended" is sometimes used and equivalent.

The requirement status also applies to all subsequent sub-provisions on a lower hierarchy-level. However, when a provision is differentiated by weakening the requirement status (e.g. a "should" or "may" under a "shall" provision), this is explicitly formulated in the provision text. In that case the less strict requirement status applies for that level / specific sub-provision.

### **Conformity with ISO 1404 and 14044**

This document has been developed with the aim of being in line with (i.e. not contradicting) ISO 14040 and 14044:2006. This is in the sense that an ILCD compliant studies will also conform with ISO 14040 and 14044:2006 (while not vice versa, as this present document is more specific). If conformity with ISO 14040 and 14044:2006 is aimed at for an LCI or LCA study, it is nevertheless recommended to have this confirmed as part of a critical review.

To ease identification, the provisions of this document that are marked "[ISO!]" are stricter than ISO 14040 and 14044:2006; in addition the right side of the frame next to that provision is a solid red line (instead of the default dotted-dashed green line). Where additional provisions are made that are not explicitly addressed in ISO 14040 and 14044:2006, the provision is marked "[ISO+]"; the right side of the frame is a dashed orange line, in that case. These marks serve for orientation only, since for some provisions it is a matter of interpretation whether they are an additional or stricter requirement, or whether they are in addition or already implicitly covered in the ISO standards. Also, some provisions combine one aspect that is in addition with another aspect that is stricter.

## **2.4 Dealing with potential omissions and contradictions in the ILCD Handbook**

Given the complexity of Life Cycle Assessment, the broad range of specific questions that can be addressed with LCA, and the degree of detail in this document, omissions and contradictions cannot be entirely ruled out. To avoid problems in application, in such cases the following overarching provision applies:

In the case of contradictions among provisions or inapplicability of any provision in the ILCD Handbook (i.e. in this document and in other ILCD Handbook documents), an LCI or LCA study can claim compliance with the ILCD Handbook if the following three requirements are met by the study:

- a) All other, unaffected provisions of the ILCD Handbook documents have been applied.

b) The general or case-specific contradiction or inapplicability is clearly identified and demonstrated. In such cases, the provision shall be used that best meets the ISO 14040 and 14044:2006 requirements.

c) If a critical review is required: The reviewer is confirming the compliance of the study or other deliverable to the above two requirements a) and b).

## Provisions: 2 How to use this document

- l) **SHALL<sup>4</sup> - ILCD Handbook compliance:** An LCI or LCA study or data set and direct LCA applications can claim compliance with the ILCD Handbook. For this they shall have been developed in line with the provisions of this document as specified in the "Provisions", including the provisions made in referenced documents and complementing information that may be given in the main part of the document, e.g. in supporting tables or in the "terms and concepts" boxes. Also specific LCI / LCA guidance documents (e.g. product-group, sector or process-type specific guides) and Product Category Rules (PCR) can claim ILCD compliance. This applies, if their provisions are compliant with the broader provisions of the ILCD Handbook and if they have undergone an ILCD compliant review as specified in the separate document "Review schemes for LCA". The following applies to compliance statements (2.3<sup>5</sup>): [ISO+]<sup>6</sup>
- I.a) The compliance statement shall refer to the applicable Situation A, B, C1, and/or C2.
  - I.b) ILCD compliance is structured into five compliance aspects that shall all be met for full compliance: Data quality, Method, Nomenclature, Review, and Documentation (chapter 12.4 gives the details).
  - I.c) Partial compliance can be claimed in a structured way by referring to any of the above five aspects, but it shall be clearly communicated in such cases that full compliance has not been achieved.
  - I.d) Purely methodological LCA studies may not be able to comply with the ILCD Handbook and the ISO 14040 and 14044, as the analysed methodological options may necessarily deviate from the provisions. Such studies may draw on the ILCD provisions, but compliance with the ILCD Handbook cannot be claimed in such cases and the impression shall be avoided as far as possible that they are compliant. Partial compliance can be reported, as detailed above.
  - I.e) Additionally, for LCI data sets, the overall data quality level attained should be documented in the data set as "High quality", "Basic quality", or "Data estimate" (see chapter 12.3 and tables of that chapter for details and definitions). The performed review type and reviewer(s), if any, shall also be identified in the data set.
  - I.f) When claiming compliance, the applied version or edition of the ILCD "General

<sup>4</sup> The meaning of the SHALL, SHOULD and MAY settings is explained in Provision II) in this set of "Provisions: 2 How to use this document".

<sup>5</sup> The sub-chapter of the main text that has more details on a specific provision is given in brackets at the end of the main provision.

<sup>6</sup> The meaning of the (ISO!) and [ISO+] settings is explained in Provision III) in this set of "Provisions: 2 How to use this document".

- guide for LCA" shall be identified in connection to the claim.
- I.g) When a new version of an ILCD Handbook component has been published, the provisions of that new version shall be applied, overruling the ones of the former version. The provisions of the preceding version can per default still be applied for ongoing studies up to a maximum of 9 months after publication of the new version. These 9 months can be modified and overruled by different provisions of ILCD system operators. If a new version of any applicable ILCD component has been published but an older version is used, the name of the component and the publication date of the new version shall be clearly and in a prominent place be identified in the study report or other deliverable that claims compliance.
- II) **SHALL - Shall, should, may:** The expression "SHALL", "SHOULD" and "MAY" in front of a (main) provision identifies its requirement status (2.3): (ISO!)
- II.a) "SHALL": the provision is a mandatory requirement and must always be followed, unless for specifically named exceptions, if any.
- II.b) "SHOULD": the provision must be followed; deviations are permissible if they are clearly justified in writing for the given case, giving appropriate details. Reasons for deviations can be that the respective provision or parts of it are not applicable, or if another solution is clearly more appropriate. If the permissible deviations and justifications are restricted, these are identified in the context of the provision.
- II.c) "MAY": the provision is only a methodological or procedural recommendation. The provision can be ignored or the issue addressed in another way without the need for any justification or explanation. NOTE: Instead of "may" the equivalent term "recommended" is sometimes used.
- II.d) The requirement status also applies to all subsequent provisions on a lower hierarchy-level (e.g. under a provision "II" also all sub-provisions "II.a", "II.b", etc.). If a provision is differentiated (e.g. a "should" or "may" under a "shall" provision), this is explicitly formulated in the provisions text.
- III) **For information/orientation only - ISO specifications and additions:** Single provisions on items that are not covered by ISO 14044:2006 are generally marked as "[ISO+]"; additionally the right border of the frame next to that provision is a dashed orange line (instead of the default dotted-dashed green line). Provisions where the ILCD provisions are more strict or specific than that which follows from applying ISO 14044:2006 are generally marked as "[ISO!]"; furthermore, the right border of the frame next to that provision is a solid red line. [ISO+]
- IV) **MAY - ISO conformity:** The document has been developed with the aim of being in line with ISO 14040 and 14044:2006, in the sense that an ILCD compliant study will also conform with ISO 14040 and 14044:2006. If conformity with ISO 14040 and 14044:2006 is aimed at for an LCI or LCA study, it is nevertheless recommended to have this confirmed as part of a critical review.
- V) **SHALL - Contradictions or inapplicabilities:** In the case of contradictions among provisions, or inapplicability of any provision in the ILCD Handbook (i.e. in this document and other ILCD Handbook documents), an LCI or LCA study can claim compliance with the ILCD Handbook if the following three requirements are met by the study (2.4):
- V.a) a) All other, unaffected provisions of the ILCD Handbook documents have been

applied.

V.b) b) The general or case-specific contradiction or inapplicability is clearly identified and demonstrated. In such cases, the provision shall be used that best meets the ISO 14040 and 14044:2006 requirements.

V.c) c) If a critical review is required: The reviewer is confirming the compliance of the study or other deliverable to the above two requirements a) and b).

VI) MAY - **How to work with this document:** Stepwise recommendations are made on how to efficiently perform an LCI or LCA study with the help of this document and the general frame of ISO 14044 (2.2.4). [ISO+]

VII) MAY - **Differences A, B, C1, C2:** A condensed, indicative overview is given on the main LCI modelling differences among the Goal Situations A, B, C1, and C2 (2.2.3). [ISO+]



### 3 Key definitions

The following key definitions are newly introduced terms or ISO terms that are used by different LCA practitioners with different meanings. These definitions should be read first for a clearer understanding of this document.

**Table 1 Key terms and definitions**

Term	Definition
Allocation [or: Partitioning]	Partitioning the input or output flows of a process or a product system between the product system under study and one or more other product systems. [Source: ISO 14044:2006]
Analysed decision	Decision that is subject to an LCA study. In contrast to LCI studies and most non-comparative LCA studies stand comparative LCA studies with a direct decision context. For these the LCA study analysis a decision rather than a single process or system.  Such can be for example the decision on alternative materials that are evaluated to be used for a product, the purchase of alternatives products that are compared, the decision on a policy option that is analysed regarding its environmental impact implications, and the like.
Assumption scenario	Scenario for the analysed process or system that varies data and method assumptions with the purpose of evaluating the robustness of the study results and conclusions. If more than one alternative system or option are compared, each of them would have its own assumption scenarios.
Attributional modelling [or: descriptive, book-keeping]	LCI modelling frame that inventories the inputs and output flows of all processes of a system as they occur.  Modelling process along an existing supply-chain is of this type.
Best attainable consensus	Partial or full agreement of the involved parties, steered by a chair or coordinator towards the broadest possible agreement on the issue at stake. In contrast to an entirely result-open process, here a solution that fits preset requirements (e.g. "define a reasonably worst case scenario") is to be found, i.e. the 'zero-option' is not an option.
Co-function	Any of two or more functions provided by the same unit process or system.
Co-product	Any of two or more products coming from the same unit process or system. [Source: ISO 14044:2006]
Comparative assertion	Environmental claim regarding the superiority or equivalence of one product versus a competing product that performs the same function. [ISO 14040:2006, ISO 14025:2006]
Comparative life cycle assessment	Comparison of LCA results for different products, systems or services that usually perform the same or similar function.
Consequential modelling	LCI modelling principle that identifies and models all processes in the background system of a system in consequence of decisions made in the foreground system
Disclosed to the public	The audience is not specifically limited and hence includes non-technical and external audience, e.g. consumers.

End-of-life product	Product at the end of its useful life that will potentially undergo reuse, recycling, or recovery.
Environmental impact	Potential impact on the natural environment, human health or the depletion of natural resources, caused by the interventions between the technosphere and the ecosphere as covered by LCA (e.g. emissions, resource extraction, land use).
Functional flow	One of the (co-)product flow(s) in the inventory of a process or system that fulfils the process' / system's function See also: Non-functional flow
Monofunctional process	Process or system that performs only one function.
Non-functional flow	Any of the inventory items that are not (co-)product flows. E.g. all emissions, waste, resources but also input flows of processed goods and of services.
Multifunctional process	Process or system that performs more than one function. Examples: Processes with more than one product as output (e.g. NaOH, Cl <sub>2</sub> and H <sub>2</sub> from Chloralkali electrolysis) or more than one waste treated jointly (e.g. mixed household waste incineration with energy recovery). See also: "Allocation" and "System expansion"
Life cycle inventory (LCI) data set	Data set with the inventory of a process or system. Can be both unit process and LCI results and variants of these.
Life cycle inventory (LCI) study	Life cycle study that provides the life cycle inventory data of a process or system.
Life cycle inventory analysis results (LCI results)	Outcome of a life cycle inventory analysis that catalogues the flows crossing the system boundary and provides the starting point for life cycle impact assessment. (Source: ISO 14040)
Overall environmental impact	Total of impacts on human health, natural environment and resource depletion for the considered impact categories. It can be calculated either as normalised and weighted overall LCIA results of the analysed process / system, or assuming an even weighting across impacts, i.e. for each and any of the impact categories.
Product	Any good or service; see "System".
Recycling, reuse, recovery	Note: In lack of a common parent term, these three terms are used in this document to identify these and similar activities, such as refurbishing, further use and the like. Casewise also the term "recycling" alone is used and meant to cover the entirety of these activities. See also "Secondary good".
Relevant	For LCI data sets: Having a significant influence on or contribution to the overall environmental impact of the analysed process or system, resulting in a different quality level. For LCA studies: Having a significant influence on or contribution to the overall environmental impact of the analysed process or system, resulting

	in different conclusions or recommendations.
Secondary good	Secondary material, recovered energy, reused part or similar as the product of a reuse, recycling, recovery, refurbishing or similar process.
Substitution	Solving multifunctionality of processes and products by expanding the system boundaries and substituting the not required function with an alternative way of providing it, i.e. the process(es) or product(s) that the not required function supersedes. Effectively the life cycle inventory of the superseded process(es) or product(s) is subtracted from that of the analysed system, i.e. it is "credited". Substitution is a special (subtractive) case of applying the system expansion principle.
System	<p>Any good, service, event, basket-of-products, average consumption of a citizen, or similar object that is analysed in the context of the LCA study.</p> <p>Note that ISO 14044:2006 generally refers to "product system", while broader systems than single products can be analysed in an LCA study; hence here the term "system" is used. In many but not all cases the term will hence refer to products, depending on the specific study object.</p> <p>Moreover, as LCI studies can be restricted to a single unit process as part of a system, in this document the study object is also identified in a general way as "process / system"</p>
System expansion	Adding specific processes or products and the related life cycle inventories to the analysed system. Used to make several multifunctional systems with an only partly equivalent set of functions comparable within LCA.
System perspective	<p>In contrast to a unit process or a part of a life cycle, the system perspective relates to the entire life cycle of an analysed system or process. For processes that implies that the life cycle is completed.</p> <p>This term is used mainly in context of identifying significant issues and quantifying inventory completeness / cut-off.</p>
Unit process	<p>Smallest element considered in the life cycle inventory analysis for which input and output data are quantified. (Source: ISO 14040)</p> <p>In practice of LCA, both physically not further separable processes (such as unit operations in production plants) and also whole production sites are covered under "unit process". See also "Unit process, black box", "Unit process, single operation", and "System".</p>
Unit process, black box	A unit process that includes more than one single-operation unit processes.
Unit process, single operation	A unit process that cannot be further sub-divided into included processes.

Some, more complex terms and concepts are explained in more detail in boxes throughout the document. See the contents of these "Terms and concepts" after the "Contents" of this document.



## 4 The iterative approach to LCA

(No specific corresponding ISO 14044:2006 chapter, but mentioned in several chapters)

### Overview

Before starting with the guidance on goal definition as first phase of performing an LCI or LCA study, in this chapter the iterative approach to LCA is explained.

### LCAs are iterative

To carry out an LCI or LCA study is almost always an iterative process: once the goal of the work is defined, the initial scope settings are derived that define the requirements on the subsequent work. However, as during the life cycle inventory phase of data collection and during the subsequent impact assessment and interpretation more information becomes available, the initial scope settings will typically need to be refined and sometimes also revised (see Figure 4). Figure 5 gives a more detailed overview of the iterations.

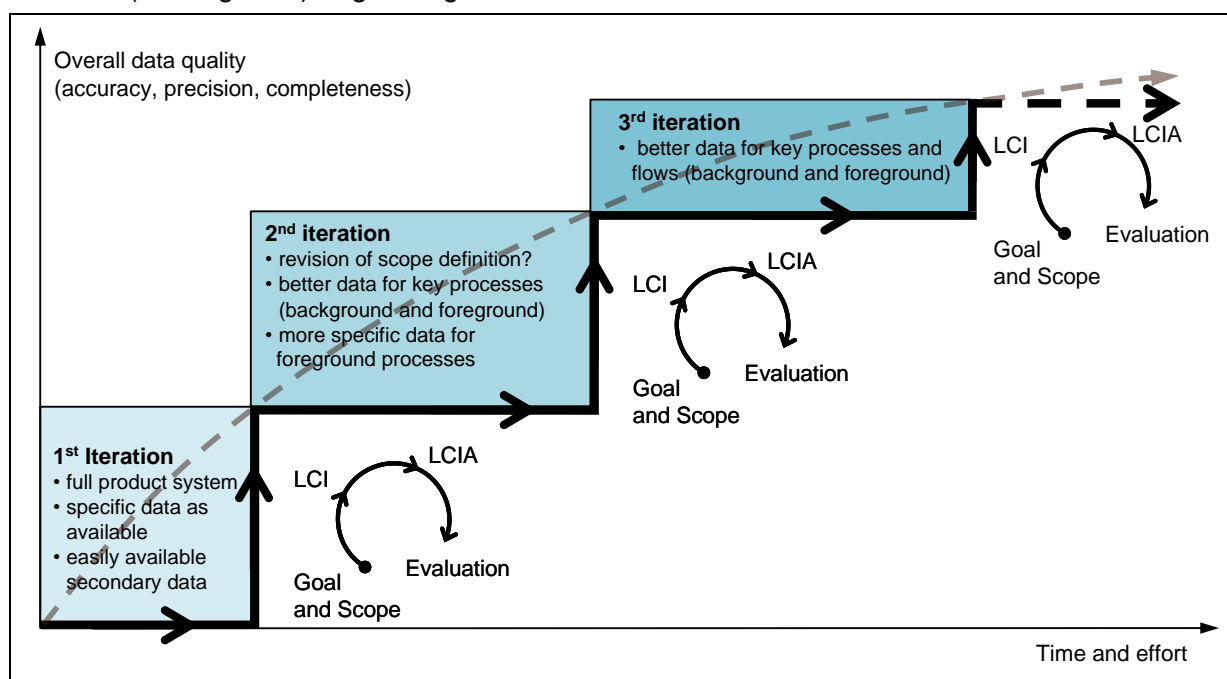

**Figure 4** Iterative nature of LCA (schematic). LCAs are performed in iterative loops of goal and scope definition, inventory data collection and modelling (LCI), impact assessment (LCIA), and with completeness, sensitivity and consistency checks (Evaluation) as a steering instrument. This is done - with a possible, limited revision of the goal and scope - until the required accuracy of the system's model and processes and the required completeness and precision of the inventory results has been attained.

In order to achieve the required precision with the minimum necessary effort, it is recommended to collect data and select external data sources in an iterative manner. Especially for fully new technologies and complex product systems on which little previous experience exists, the first iteration may use generic or average data for the background and also many parts of the foreground system (see Terms and concepts box "Foreground system and background system" in chapter 6.6.1). This can be combined with expert judgement to identify the key processes and elementary flows of the product system. The main effort of data collection and acquisition can thereby be focussed on the relevant parts of the system.

## Documentation in parallel to work

It is recommended to document the details of the initial goal and scope definition, key LCI and LCIA items, and the key initial results of the sensitivity, consistency and completeness checks along the provisions of reporting required for the deliverable. Keep track of data sources and initial calculations, on paper and/or digitally.

Use this preliminary report as a living reference during the subsequent work and repeatedly revise and fine-tune it in course of the iterations towards the final report (being a data set and/or study report).

## The iterations

The inventory phase is building on the decisions made during goal and scope definition. It is preparing the input for the impact assessment and interpretation phases, be it directly as a step within an LCA study or in other studies that use the resulting inventory data. Findings in the impact assessment and the sensitivity and contribution analysis, which are performed as part of the interpretation, help identifying the most relevantly contributing (“key”) processes and elementary flows of the system. A completeness and consistency check complements this.

After the initial LCI screening modelling the achieved completeness, accuracy and precision of the data for some of the key processes, parameters and elementary flows may be insufficient to meet the overall requirements to the LCI/LCA study (as derived from the goal definition and intended applications). These key processes, parameters and elementary flows become the focus of the next iteration: the inventory is improved by further foreground data collection or by using better and more appropriate generic or average data, to achieve the required completeness, accuracy, and precision of the overall data and results. The inventory that results from this second iteration of data collection is again subjected to impact assessment and to sensitivity and contribution analysis as well as completeness and consistency check, providing feedback to possible additional iterations of the inventory data collection until the required overall accuracy, precision and completeness has been reached.

For data that were initially assumed to be of little significance but for which the sensitivity analysis has revealed relevance, improve the quality of these data. Use sufficiently good data estimates for these life cycle stages, activity types, processes or specific elementary flows. In the case sufficiently good data estimates are not available, entirely leave out the respective processes and flows and document the gap.

This iterative improvement of the inventory is accompanied by a preceding fine-tuning of the scope definition at the beginning of each iteration. To name some of the relevant scope aspects often affected:

- The previously included and excluded activities, processes and elementary flows may need to be adjusted.
- Also the initial specific provisions for solving multifunctionality may need to be further detailed or revised.
- In comparative studies the initially defined scenarios may need revision or expansion by additional ones based on new insights during data collection and modelling e.g. of product use patterns.
- In few cases newly identified and potentially relevant elementary flows may require to develop additional impact characterisation factors.
- In rare cases newly identified kinds of relevant environmental impacts may even require to add new impact categories and models.

Figure 5 gives a more detailed overview.

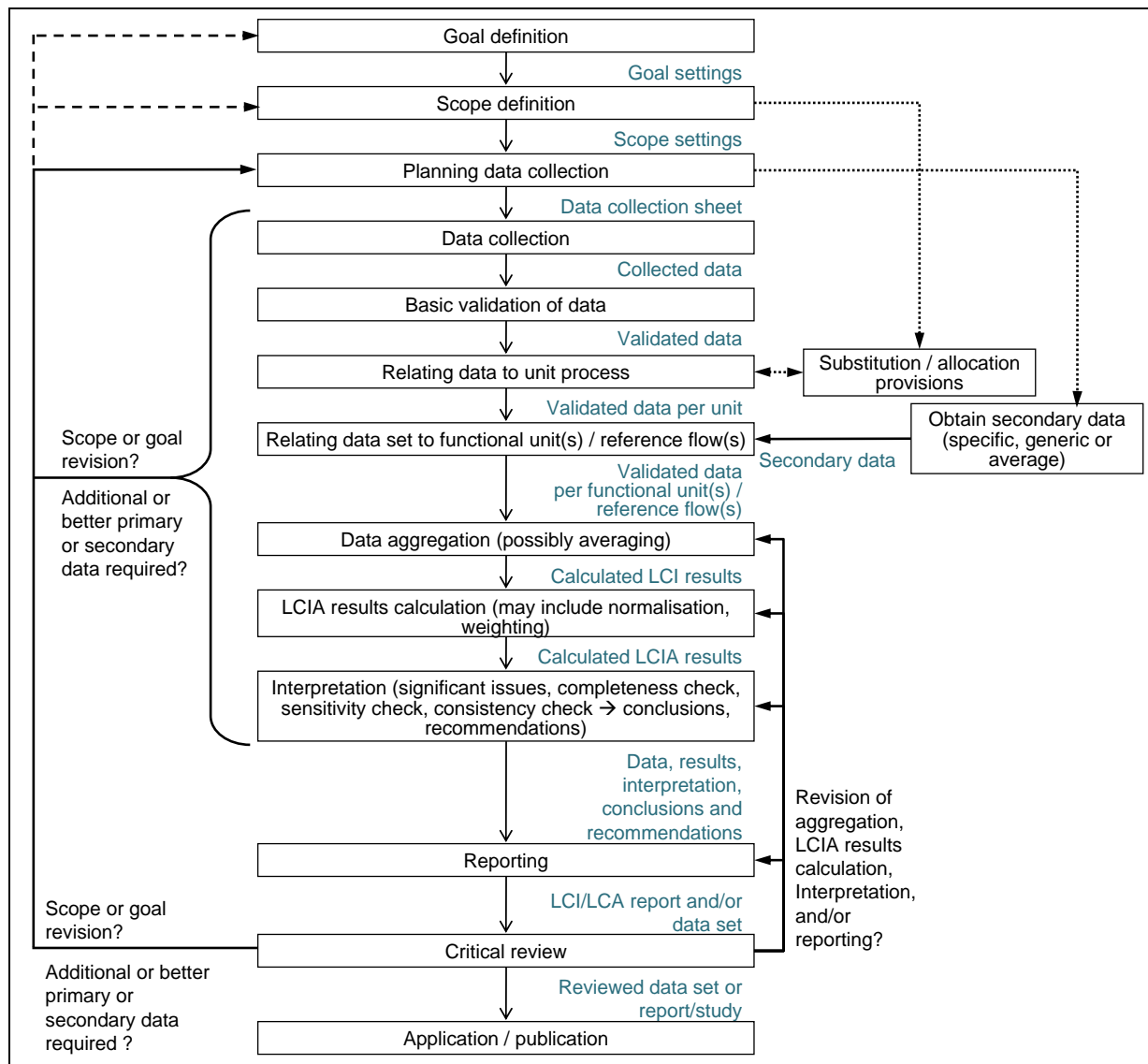

**Figure 5** Details of the iterative approach to LCA, with focus on inventory data collection and modelling (from ISO 14044:2006, modified).

### Critical review

It is recommended to identify and involve critical reviewer(s) from the beginning of the study, including when defining goal and scope. Review requirements are addressed in chapter 6.11.

### Limitations of reaching the required overall accuracy, precision and completeness

Depending on the specific study, it can happen that also after three or even four iterations the required precision cannot be achieved. In comparative studies this can be e.g. if the compared alternatives have a so similar environmental performance that an environmentally significant "better" alternative cannot be singled out, because the basic uncertainty does not permit this. As the additional relative effort per improvement increases with each iteration and as the uncertainty cannot be reduced to zero, in such cases it is practically not possible to conclude a relevant difference. This however also means that the real difference of the overall environmental impact is not that big and there is no relevant environmental advantage of the only slightly better alternative over the less good one.

Especially for studies on systems that have main parts in the further away future or where the key processes are new technologies, the high uncertainty may make it impossible to clearly differentiate even between options that potentially have relevant differences in their environmental impact.

In other cases a limited access to required key data or lack of resources or funds may hinder to further improve the overall data quality. Especially this case shall not be used to conclude that significant differences do not exist (see also annex 15.3 on preventing misleading result interpretation).

Sometimes the iterations lead to identification of issues that cannot be resolved and which require more substantial revisions of the goal or scope definition of the LCI/LCA study. This is to be documented in the reporting.

### Provisions: 4 The iterative approach to LCA

- I) **MAY - Overview of iterative approach:** It is recommended taking an iterative approach to the LCI/LCA study (for more detail see chapter 2.2.4):
  - I.a) Define the goal aspects as precisely as possible in the beginning of the study (see chapter 5.2).
  - I.b) Derive an initial scope definition from the goal definition as far as initial knowledge permits (see chapter 6).
  - I.c) Compile easily available Life Cycle Inventory data for the foreground and background system. Model the process or system (e.g. product) as far as the initial information and data permits (see chapter 7).
  - I.d) Calculate the LCIA results (see chapter 8).
  - I.e) Identify significant issues and perform first sensitivity, consistency and completeness checks on this initial model (see chapter 9).
  - I.f) Based on this go to the next iteration: Start with fine-tuning or revising the scope (in some cases even the goal), improve the life cycle model accordingly, etc.
  - I.g) Expect two to four iterations towards completing the study. This will mainly depend on the quality needs or ambition, the complexity of the analysed process(es) or system(s), on the specifically analysed question(s), and data availability and its quality. [ISO+]
  - I.h) Starting from the beginning of the study, document the details of the initial goal and scope definition, key LCI and LCIA items, and the key initial results of the sensitivity, consistency and completeness checks. Let this be guided by the main provisions of reporting required for the deliverable. During subsequent iterations, use this preliminary core report as work in progress and constantly revise, fine-tune and complete it towards the final report (be it a data set and/or a study report). [ISO+]
- II) **MAY - Early identification of reviewers:** From the beginning of the study, it is recommended to identify and involve critical reviewer(s) and - if required or desired - interested parties, including when defining goal and scope. [ISO+]

All these provisions refer especially to the system(s) modelled under Situation B (i.e. for meso / macro-level decision support studies) .



# 5 Goal definition – identifying purpose and target audience

(Refers to ISO 14044:2006 chapter 4.2.2)

## 5.1 Introduction and overview

(Refers to aspects of ISO 14044:2006 chapter 4.2.2)

### Introduction

The goal definition is the first phase of any life cycle assessment, independently whether the LCI/LCA study<sup>7</sup> is limited to the development of a single unit process data set or it is a complete LCA study of a comparative assertion to be published.

During the goal definition among others the decision-context(s) and intended application(s) of the study are identified and the targeted audience(s) are to be named.

The goal definition is decisive for all the other phases of the LCA:

- The goal definition guides all the detailed aspects of the scope definition, which in turn sets the frame for the LCI work and LCIA work.
- The quality control of the work is performed in view of the requirements that were derived from the goal of the work.
- If the work goes beyond an LCI study, the final results of the LCA are evaluated and interpreted. Also this is to be done in close relation to the goal of the work.

A clear, initial goal definition is hence essential for a correct later interpretation of the results. This includes ensuring as far as possible that the deliverables of the LCI/LCA study cannot unintentionally and erroneously be used or interpreted beyond the initial goal and scope for which it was carried out.

Annex 15 exemplarily identifies and illustrates issues that must be avoided for a non-misleading goal and scope definition and results interpretation.

### Overview

Six aspects shall be addressed and documented during the goal definition:

- Intended application(s) of the deliverables / results (chapter 5.2.1)
- Limitations due to the method, assumptions, and impact coverage (5.2.2)
- Reasons for carrying out the study and decision-context (5.2.3)
- Target audience of the deliverables / results (5.2.4)
- Comparative studies to be disclosed to the public (5.2.5)
- Commissioner of the study and other influential actors (5.2.6)

The various detailed implications on method, documentation, review etc. that these specific aspects have, are addressed throughout this document.

---

<sup>7</sup> The term "LCI/LCA study" is used wherever the text applies to both LCI studies (i.e. with a life cycle inventory as deliverable, e.g. a LCI data set) and LCA studies (which is often comparative and always includes an interpretation and potentially conclusions and recommendations).

Finally, in order to help in the subsequent scope definition, especially regarding identifying the appropriate LCI modelling frameworks and method approaches:

- Classification of the decision-context of the LCI/LCA study (5.3).

The methodological provisions for the different decision-contexts and the to-be-derived archetypal goal situations are addressed in chapter 6.5.4.

## 5.2 Six aspects of the goal definition

(Refers to ISO 14044:2006 chapter 4.2.2)

### 5.2.1 Intended application(s)

(Refers to aspect of ISO 14044:2006 chapter 4.2.2)

#### **Studies in relationship to decision support and accounting/monitoring**

The goal definition shall firstly state the intended application(s) of the LCA results in a precise and unambiguous way (e.g. “Comparative assertion of the overall environmental impacts associated with nation-wide recycling (Option I) or incineration (Option II) of all used office paper in Australia”<sup>8</sup>).

The following LCA applications are the most frequently used ones, but others may be identified and used as well:

- Identification of Key Environmental Performance Indicators (KEPI) of a product group for Ecodesign / simplified LCA
- Weak point analysis of a specific product
- Detailed Ecodesign / Design-for-recycling
- Perform simplified KEPI-type LCA / Ecodesign study
- Comparison of specific goods or services
- Benchmarking of specific products against the product group's average
- Green Public or Private Procurement (GPP)
- Development of life cycle based Type I Ecolabel criteria
- Development of Product Category Rules (PCR) or a similar specific guide for a product group
- Development of a life cycle based Type III environmental declaration (e.g. Environmental Product Declaration (EPD)) for a specific good or service
- Development of the “Carbon footprint”, “Primary energy consumption” or similar indicator for a specific product
- Greening the supply chain
- Providing quantitative life cycle data as annex to an Environmental Technology Verification (ETV) for comparative use
- Clean Development Mechanism (CDM) and Joint Implementation (JI)

---

<sup>8</sup> To improve the reading flow, longer illustrative in-line examples are formatted in grey.

- Policy development: Forecasting & analysis of the environmental impact of pervasive technologies, raw material strategies, etc. and related policy development
- Policy information: Basket-of-products (or -product groups) type of studies
- Policy information: Identifying product groups with the largest environmental impact
- Policy information: Identifying product groups with the largest environmental improvement potential
- Monitoring environmental impacts of a nation, industry sector, product group, or product
- Corporate or site environmental reporting including calculation of indirect effects in Environmental Management Systems (EMS)
- Certified supply type studies or parts of the analysed system with fixed guarantees along the supply-chain
- Accounting studies that according to their goal definition do not include any interaction with other systems
- Development of specific, average or generic unit process or LCI results data sets for use in specified types of LCA applications<sup>9</sup>

Note that often several, separate applications are intended by a study (e.g. developing an EPD and performing an internal benchmark). Or the application is combined with cost, social, or other complementary environmental information (e.g. combining a product comparison based on environmental LCA results with life cycle cost information when performing an eco-efficiency type analysis).

Note that certain applications have specific requirements under ISO 14040 and 14044:2006, e.g. regarding review and reporting for comparative assertions disclosed to the public. Also LCI and LCIA data sets for intended use for EPDs and in comparative contexts imply additional requirements. Table 3 in scope chapter 6.3 gives more information.

Note also that the different applications require different methodological approaches for the LCI modelling; details on the directly related three archetypal goal situations that are differentiated here are given in chapter 5.3. This means that also different background data might be required for applications of substantially different decision-contexts.

Note finally that the subject of the study is often named during the goal definition for clarity reasons while it is formally a scoping issue. If however the goal is defined on a more general level, the specific subject(s) can only be identified during the scope phase.

### **Purely methodological studies without relationship to decision support and accounting / monitoring on the studies object**

Studies that do not have the goal to provide information in support of any decisions on the analysed object or accounting / monitoring information, but are LCA studies to analyse methodological issues need to have the liberty to vary all methodological issues freely. Such studies may therefore not be able to meet the ILCD requirements or ISO 14040 and 14044 requirements.

---

<sup>9</sup> It is important to note that specific types of LCA applications require LCI background data sets that are modelled in a suitable way. In the ILCD guidance three main types of decision-contexts / goal situations are differentiated. This will be addressed in chapter 5.3.

At the same time it is recommended that such studies implement the provisions of ISO 14040 and 14044 and of the ILCD handbook, to ease uptake of the study's methodological findings in the further development of ISO and the ILCD.

However, accordingly such studies can not claim to be ILCD or ISO compliant. When the audience of such studies is informed that parts of the ILCD Handbook provisions have been used, the impression shall be avoided that such studies would be ILCD compliant by explicitly stating that fact. It should equally be made clear to the audience that such studies do explicitly not aim at decision support or providing monitoring information on the analysed objects and must not be used for such purposes or applications.

When such studies contain comparative elements, care should be taken to not give the impression to the audience that the results of the study imply any comparative message on the analysed objects. This should be stated explicitly and clearly visible.

The intended application of such studies would hence be to gain purely methodological insights.

## 5.2.2 Method, assumption and impact limitations (e.g. Carbon footprint)

(No corresponding ISO 14044:2006 chapter; implicitly covered in various chapters)

### Introduction

If the goal definition implies specific limitations of the usability of the LCA results due to the applied methodology, assumptions made or limited impact-coverage, such shall equally be clearly identified and later be prominently reported (see chapter 10). The identification and appreciation of such limitations needs a relevant degree of expertise and experience. Often the limitations need to be adjusted or expanded during the course of the study.

### Carbon footprint and other studies with limited impact coverage

A prominent example of impact-coverage related limitations is the case of Carbon footprint calculations where exclusively climate change related greenhouse gas emissions are considered. Such an initial limitation can be fully justified, if the overall environmental impacts of the analysed product (and its competing products) are by far dominated by climate change impacts or if all other individually relevant impacts such as Eutrophication and Acidification are very closely and positively correlated with Climate change. Otherwise such limitations in the initial settings can result in inadequacy for comparisons (e.g. if two compared products clearly differ in their environmental impacts in other impact categories). The same applies analogously for primary energy consumption studies where only energy consumption related resource flows are included, or other such kinds of limitations.

### Method-related limitations

Also methodological limitations can limit the possibility for drawing general conclusions or for using the resulting LCI data in other studies. Methodological limitations refer for example to limitations that are inherent to the conventional, site-unspecific LCIA: if the results of such a study are intended to inform a decision on a specific site with uncommon characteristics (e.g. being located on an island) they are unsuitable. Other method-related limitations can be caused by the specific LCI method approach chosen. For example may the use of market price based allocation partly or entirely prevent the use of the results in eco-efficiency studies since the environmental results are correlated with the market price.

## Assumption-related limitations

Assumptions on the characteristics of the analysed system<sup>10</sup> or on specific scenarios equally can limit the usability and transferability of the results. This can be, for example, if an analysed product scenario is very specific regarding time representativeness (e.g. "peak power supply"), location (e.g. in a country of climate zone for which the product was not designed), use-pattern (e.g. outside the product's main purpose), etc., i.e. in a way that is atypical for the analysed system.

## Niche markets

A special case in this context are restrictions due to analysing a "niche market": A market niche is a sub-category of a market segment, where a part of the customers consider only products with specific properties substitutable (i.e. those properties that characterise the specific niche (e.g. "refillable packaging" in the market "packaging"), although the majority of the consumers perceives comparability between products from the niche and other products in the segment (i.e. in this example including "non-refillable packaging"). Aspects that separate a niche market from the main market are among others:

- price (i.e. investment cost of a good or life cycle cost / total-cost-of-ownership),
- life-style and value-system related issues (e.g. "green" image in general or more specific such as "locally produced", "bio-based", "recycled", "recyclable", "ecolabelled", etc., or "social" image in general or more specific such as "fair-traded", "free-of-child-work", etc. or aspects such as "fashionable", "modern", "prestige", "young", etc.)
- high quality, durability / longevity,
- practicality and/or time-saving.

Studies on niche markets hence initially limit the to-be-included types of products, although from a purely technical perspective also products outside the specific niche would need to be included to avoid a potentially misleading comparison. In the interpretation phase of such studies the limited conclusions shall be explicitly and well visibly highlighted.

## 5.2.3 Reasons for carrying out the study, and decision-context

(Refers to aspect of ISO 14044:2006 chapter 4.2.2)

The goal definition shall explain the reasons for carrying out the LCI/LCA study, name the drivers and motivations, and especially identify the decision-context (e.g. for the above example: "Support decision on governmental non-binding<sup>11</sup> recommendations for environmentally preferred future handling of paper waste from commercial and governmental offices in Australia").

The decision-context is one key criterion for determining the most appropriate methods for the LCI model, i.e. the LCI modelling framework (i.e. "attributorial" or "consequential") and the related LCI method approaches (i.e. "allocation" or "substitution") to be applied. Chapter

<sup>10</sup> The term "system" is used throughout the text instead of the more classical term "product system" because many other systems are analysed with LCA (e.g. sites, raw material strategies, needs fulfilment (e.g. mobility solutions) that go beyond a single product system).

<sup>11</sup> In the case the context was to inform the establishment of a legally binding policy, this would imply a different setting: in that case the future scenarios would assume that the paper waste would be handled almost entirely according to the assumed legislation. For the here used example of a non-binding recommendation, the future scenarios would arguably need to model a clearly lower share of implementation, what may effect the LCI model. This example illustrates the importance of a very clear and well specified goal definition in all its aspects, before continuing with the scope definition or even LCI data collection.

5.3 provides the details on the formal approach to derive the applicable goal situation from the intended application and general decision-context.

The decision-context also directly determines other key aspects of the scope definition, of decisions to be made during inventory data collection and modelling, the calculation of impact assessment results, and finally for LCA studies also the LCA results interpretation.

The stated reasons for a study indicate the quality ambitions and are a basis to judge among others data quality needs but also potential special review needs beyond the minimum requirements. The latter can be given for example if for a planned national legislation an involvement of trade partners in the review process would be wanted for improving international acceptance.

## 5.2.4 Target audience

(Refers to aspect of ISO 14044:2006 chapter 4.2.2)

The goal definition shall identify the target audience of the study, i.e. to whom the results of the study are intended to be communicated. This serves among others to help identifying the critical review needs and the appropriate form and technical level of reporting. For the above example this could be “The target audience are governmental political decision makers and main stakeholders of the paper production and waste management sectors in Australia, as well as operators of offices in the private sectors and in government”.

Different types of target audiences (i.e. “internal” vs. “external” and “technical” vs. “non-technical”) typically imply different scoping requirements on documentation, review, confidentiality and other issues that are derived from the audiences’ needs. The target audience(s) are hence to be identified already during the goal definition.

## 5.2.5 Comparisons intended to be disclosed to the public

(Refers to aspect of ISO 14044:2006 chapter 4.2.2)

The goal definition shall furthermore explicitly state whether the LCA study includes a comparative assertion intended to be disclosed to the public<sup>12</sup>. In the above end-of-life paper management example it should hence be stated: “The study includes a comparative assertion and is planned to be disclosed to the public”.

This aspect entails a number of additional mandatory requirements under ISO 14040 and 14044:2006 on the execution, documentation, review and reporting of the LCA study due to the potential consequences the results may have for e.g. external companies, institutions, consumers, etc.

To avoid a by-passing of this ISO requirement by publishing product comparisons that show e.g. along the numbers or graphics the environmental performance of the compared products but without explicitly making an assertion as to superiority or equality, also comparative but not assertive LCA studies shall meet these requirements, as far as

---

<sup>12</sup> All provisions of the entire ILCD Handbook refer to external use only. In-house decision support by LCA may draw on them but is outside any ruling, of course. “Disclosed to the public” refers here to the accessibility of the study or any of its results, conclusions, or recommendations to an audience outside the commissioner of the study, the involved experts, and any explicitly and individually named limited audience (e.g. an identified list of suppliers, customers, etc.)

applicable<sup>13</sup>. Note that "comparison" here refers to a comparison between systems (e.g. products), but not within a single system (i.e. not to a contribution or weak point analysis).

Note that, also according to ISO 14044:2006, an LCI study alone shall not be used for comparative assertions intended to be disclosed to the public, i.e. a life cycle impact assessment and evaluation / interpretation shall be performed as well.

Finally, LCI data sets that are foreseen to be used by other actors as background or foreground data for comparisons or comparative assertions shall also fulfil those of these requirements that are applicable<sup>13</sup>. In this case the data set developer ensures that these requirements - including the review - are met. This yields "pre-verified data for comparative assertions". Otherwise, any steps to meet missing or stricter requirements (e.g. having a panel review done instead of a single independent external review) have to be taken by the other actor who uses these data in its comparative study / assertion.

## 5.2.6 Commissioner of the study and other influential actors

(No corresponding ISO 14044:2006 chapter; implicitly covered in various chapters)

Finally, the goal definition shall identify who commissioned the LCI/LCA study (e.g. for the above example: "The study is commissioned by the Australian Agency for Protection of the Environment<sup>14</sup>, co-financed by the Australian Association of Paper Producers"). Also all (co-)financing or other organisations that have any relevant influence on the study shall be named; this includes especially the LCA experts that perform the LCI/LCA study (respectively their organisation(s)).

### Provisions: 5.2 Six aspects of goal definition

- I) **SHALL - Intended applications:** Unambiguously identify the intended applications of the deliverable of the LCI or LCA study (5.2.1).
- II) **SHALL - Limitations of study:** Unambiguously identify and detail any initially set limitations for the use of the LCI/LCA study. These can be caused by the following (5.2.2):
  - II.a) **Impact coverage limitations** such as in Carbon footprint calculations
  - II.b) **Methodological limitations** of LCA in general or of specific method approaches applied
  - II.c) **Assumption limitations:** Specific or uncommon assumptions / scenarios modelled for the analysed system [ISO+]

Note that the initially identified limitations may need to be adjusted during the later LCA phases when all the related details are clear.

Other possible limitations due to lack of achieved LCI data quality may also restrict the applicability; these are identified in the later interpretation phase of the study.

<sup>13</sup> "applicable" means all requirements except for those that relate to the not covered parts: For product comparisons without conclusions and recommendations, the assertion-related provisions do not apply / cannot be applied. For LCI data sets all provisions that relate to the comparison do not apply / cannot be applied, as the comparison is done in the subsequent, external use of the LCI data set.

<sup>14</sup> This and all other organisation names, product types / materials, brands and the like are purely illustrative and/or fictional.

- III) SHALL - **Reasons for study:** Unambiguously identify the internal or external reason(s) for carrying out the study and the specific decisions to be supported by its outcome, if applicable (5.2.3).
- IV) SHALL - **Target audience of study:** Unambiguously identify the audience(s) to whom the results of the study are foreseen to be communicated (5.2.4).
- V) SHALL - **Type of audience:** Classify the targeted audience(s) as being “internal”, “restricted external” (e.g. specific business-to-business customers), or “public”. Differentiate also between “technical” and “non-technical” audience (5.2.4). [ISO+]
- VI) SHALL - **Comparisons involved?:** Unambiguously state whether the study involves comparisons or comparative assertions across systems (e.g. products) and whether these are foreseen to be disclosed to the public (5.2.5). [ISO!]
- VII) SHALL - **Commissioner:** Identify the commissioner of the study and all other influential actors such as co-financiers, LCA experts involved, etc. (5.2.6).

## 5.3 Classifying the decision-context as Situation A, B, or C

(No corresponding ISO 14044:2006 chapter)

### 5.3.1 Possible decision-context situations

During the goal definition, the decision-context shall be identified. Three different decision-context situations of practical relevance in LCA can be differentiated. They differ in two<sup>15</sup> aspects:

- regarding the question whether the LCI/LCA study is to be used to support a decision on the analysed system (e.g. product or strategy),
  - and, if so: by the extent of changes that the decision implies in the background system and in other systems and that are caused via market mechanisms. These can be "small" (small-scale, non-structural) or "big" (large-scale, structural).
  - and, if not so: whether the study is interested in interactions of the depicted system with other systems (e.g. recycling credits) or not

The LCI modelling logic behind this differentiation is necessarily explained in the later chapters after the related concepts of attributional and consequential modelling and of short-term and long-term marginal processes have been introduced. The principle considerations

<sup>15</sup> The "time" a study refers to (e.g. past / retrospective for 1990 or future / prospective for 2025) does not affect the LCI modelling principles and method approaches but only the required time-representativeness of the used LCI data. Note that the life cycles of long-living products (e.g. houses) may stretch from the past well into the future. Hence also the use of e.g. forecasting and other scenario techniques, learning curves etc. are not a specific characteristic of any single goal situation but go across all of them. It is sometimes argued that the time-horizon "future" would be associated with "consequential modelling", while the "past" with "attributional modelling". However also future attributional data can be of interest (e.g. when extrapolating national, annual accounting data) as well as retrospective consequential modelling (i.e. "How would the inventory of product X have been if in the past the decision Y would have been made...?"), while this latter case is of only theoretical interest. In conclusion however "time" is not a discriminating aspect for LCI methodological questions.



are however briefly sketched here to ease understanding of the implications of this classification:

### 5.3.2 Studies on decisions

The first of these two aspects - whether a decision is to be supported - implies whether the study is interested in the potential consequences of this decision (e.g. whether the analysed decision on the choice of material X or Y for a product results in an additional amount of material X or Y to be produced). If this is the case, the LCI model should as good as possible reflect these consequences, e.g. how is the additionally required material produced? Does it even mean that new production facilities, employing distinct technologies need to be built? In contrast, if no decision support is involved, the LCI model should describe the analysed system as it is, without including any market consequences in the model (as no decision consequences are related to it).

The second aspect - the extent of changes - further differentiates the decision support cases: Firstly, there are cases with only small-scale, non-structural consequences in the background system and potentially on other systems of the economy. These cases imply that only the extent is changed to which already installed equipment e.g. of a production facility is used (e.g. the existing technologies that produce material X). In the LCI model, the additional demand<sup>16</sup> would then be modelled with the processes of the existing equipment / technologies. Secondly, there are cases that have large-scale, structural effects. These cases imply that the analysed decision results in additionally installed equipment or in its decommissioning beyond its normal phasing out (e.g. new production plants/technologies for material X need to be installed or old ones taken out of operation in direct market consequence of the analysed decision). I.e. at least parts of the technologies / equipment in the background system and/or other systems in the economy change as consequence of the analysed decision. Often only a few processes actually have these large-scale effects and only those need the respective modelling; most of the background system will only have small-scale effects. However, for those processes affected, the difference between the "big" and "small" cases can be substantial, as newly installed technologies (e.g. second generation biofuel production plants) may differ fundamentally from the currently installed technologies that are modelled in case of small-scale consequences.

It is important to stress that the above refers to changes in the background system or other systems that are caused via market-mechanisms, i.e. in reaction to changed demand and supply resulting from the analysed decision. Direct changes in the foreground system, (e.g. the installation of a new technology that is analysed or is required to be installed at the producer's site as part of the analysed question) are to be modelled as explicit scenarios in both cases.

### 5.3.3 Studies of descriptive character

Coming back to the case of a study that does not imply a direct decision-support in the way as defined above, i.e. not resulting in additional production, but being of an accounting / monitoring character: in that case, the LCI model will describe the system as it can be measured. However, for this case, two subtypes of studies can be differentiated: these are firstly studies that are interested in including any existing benefits the analysed system may have outside this system (e.g. benefits of recycling or of co-products that avoid producing

---

<sup>16</sup> This applies analogously to additional supply and substitution, of course. This will be detailed later when the LCI modelling is explained.

them in other ways). And secondly studies that aim at analysing the system in isolation without considering such interactions.

Table 2 gives an overview of the resulting, practically relevant three archetypal goal situations that will be referred to throughout this document to provide the required, differentiated methodological guidance:

**Table 2** Combination of two main aspects of the decision-context: decision orientation and kind of consequences in background system or other systems.

		Kind of process-changes in background system / other systems	
		None or small-scale	Large-scale
Decision support?	Yes	<b>Situation A</b> <b>"Micro-level decision support"</b>	<b>Situation B</b> <b>"Meso/macro-level decision support"</b>
	No	<b>Situation C</b> <b>"Accounting"</b> <b>(with C1: including interactions with other systems, C2: excluding interactions with other systems)</b>	

The decision-context of the LCI/LCA study to be performed shall be classified as belonging to any of these three archetypal goal situations that are further characterised and illustrated as follows (see also Table 3 that maps widely used LCA applications with the corresponding Situation A, B, or C):

### 5.3.4 Situation A

#### **Terms and concepts: Situation A ("Micro-level decision support")**

Decision support on micro-level (e.g. for product-related questions).

The most relevant applications of this goal situation are:

- Identification of Key Environmental Performance Indicators (KEPI) of a product group for Ecodesign / simplified LCA
- Weak point analysis of a specific product
- Detailed Ecodesign / Design-for-recycling
- Perform simplified KEPI-type LCA / Ecodesign study
- Comparison of specific goods or services
- Benchmarking of specific products against the product group's average
- Green Public or Private Procurement (GPP)
- Development of life cycle based Type I Ecolabel criteria
- Development of Product Category Rules (PCR) or a similar specific guide for a product group
- Development of a life cycle based Type III environmental declaration (e.g. Environmental Product Declaration (EPD)) for a specific good or service

- Development of the “Carbon footprint”, “Primary energy consumption” or similar indicator for a specific product
- Greening the supply chain
- Providing quantitative life cycle data as annex to an Environmental Technology Verification (ETV) for comparative use
- Clean Development Mechanism (CDM) and Joint Implementation (JI)
- Development of specific, average or generic unit process or LCI results data sets for use in Situation A

Situation A refers to decision support directly or indirectly related to inform the purchase of products that are already offered in the market. Or to inform the design / development of products that are foreseen to entering the market. Accordingly, the product can be assumed to be produced only as consequence of the decision to be supported by the LCI/LCA study, i.e. in addition. Note that these "products" can be any good or service (including materials, energy carriers, machines, complex consumer products, events, personal services, cleaning, etc.) both being direct subject of the study or indirectly affected by the analysed decision (e.g. choice of a material for a product that is produced in the background system).<sup>17</sup>

Given the limited share the total production of any single product<sup>18</sup> has in an industrial sector, its production, use and end-of-life can be reasonably expected to cause none or only small changes in the background system or other systems of the economy that would not directly or indirectly structurally change it. Structural changes means e.g. the installation of new production plants or even technologies. Hence the term "micro-level" referring to changes that are caused via market mechanisms but only with small-scale consequences beyond the foreground system. These small-scale consequences may change the extent to which existing equipment / capacity is used, but **without resulting in additionally** installed or decommissioned equipment / capacity, beyond the independently ongoing installation and decommissioning. Small-scale marginal consequences alone are not strong enough to overcome thresholds and trigger large-scale consequences in the market.

Typical keywords of such Situation A LCI/LCA studies are “decision support” related to “product comparison”, “comparative assertion”, “product advance development”, “product development”, “product design”, “weak point analysis”, “product benchmarking” “face-lift”, etc.

Situation A hence covers all studies that are intended to support any kind of product / micro level comparisons and comparative assertions.

A typical example for a Situation A study is the purchase decision support: “Which of the pre-selected five technically suitable photocopier models is environmentally best performing over its life cycle?”

<sup>17</sup> Typically, but not necessarily, these cases refer to products being made in the short-term (up to 5 years from present) or mid-term (5 to 10 years from present) future. (The policy usage of "short-term" and "mid-term" is adopted here.) Note that the use and end-of-life stages of long-living products may continue well beyond this time-frame.

<sup>18</sup> There are a few cases where the relevance of a single product may be higher, e.g. in highly monopolised markets. Also, if a product group (e.g. "diesel fuel") is understood to be one product, while more accurate the product would be the diesel fuel of brand X. In this general form the "product" that can have a high share in the sector. In such cases where a clear classification of a study as Situation A or B is not possible, see the explanation and procedure given after the box for Situation B.

An in-house decision support example would be an ecodesign study modelling a new type of computer mouse comparing different polymers for the casing.

Equally, developing a product's Environmental Product Declaration (EPD) or its Carbon footprint data for informing potential customers are examples of Situation A studies.

Situation A also covers the development of LCI and LCIA data that are meant to be used in LCA-based decision support (e.g. producer specific LCI data sets, LCIA results data sets, generic and average LCI data sets for background use, etc.).

### 5.3.5 Situation B

#### **Terms and concepts: Situation B ("Meso/macro-level decision support")**

Decision support on a meso or macro-level, such as for strategies (e.g. raw materials strategies, technology scenarios, policy options, etc.).

The most relevant applications of this goal situation are:

- Policy development: Forecasting & analysis of the environmental impact of pervasive technologies, raw material strategies, etc. and related policy development
- Policy information: Identifying product groups with the largest environmental improvement potential
- Development of specific, average or generic unit process or LCI results data sets for use in Situation B

Situation B refers to life cycle based decision support with consequences that are so extensive that they overcome thresholds and **result in additionally** installed or additionally decommissioned equipment / capacity (e.g. production infrastructure) outside the foreground system of the analysed system. I.e. the analysed decision and related changes in production, use and end-of-life activities somewhere in the life cycle will via market mechanisms change parts of the rest of the economy by having large-scale structural effects<sup>19</sup>. Small-scale marginal consequences alone shall not be considered resulting in large-scale consequences, as they are too small to overcome thresholds.

As a purely illustrative example, against the base-line scenario of autonomous development, the environmental implication of incinerating all Russian post-consumer waste might be analysed, recovering the energy and utilising it for electricity production. This would have consequences for the overall electricity production and investments into other electricity-producing technologies in Russia at a large scale. And it would affect the alternative uses of the waste (e.g. recycling of paper and plastic from packaging and other products, as being part of the base-line scenario). This would lead to changes of installed recycling capacity at a sector level. Note however that most background processes will be affected by small-scale consequences only.

---

<sup>19</sup> These cases refer typically to the mid-term (5 to 10 years from present) or long-term (beyond 10 years from present) future.

Another example would be a study analysing e.g. the mandatory replacement by 2025 of 50 % of diesel fuel in the U.S. by crop-based bio-diesel, what would have substantial effects on the U.S. and even global agriculture, petro-refineries, and other sectors<sup>20</sup>.

We are thus looking at changes with structural market implications beyond the foreground-system. This situation covers scenarios addressing questions like “Which pervasive technology system, raw material base, etc. is environmentally preferable over its life cycle?” Such studies are typically strategic political studies or LCA-supported strategic research studies, which due to the extent of consequences have a high relevance for society and - next to appropriate LCI modelling - also require special attention regarding review.

It is important to note that also for such studies not all processes throughout the analysed system's life cycle show these large-scale effects. For example, consumables that are required only in small amounts are only affected with small-scale consequences. In fact, under Situation B, the majority of processes by number often will have only small-scale effects and the respective processes would be modelled according to Situation A. The key difference between Situation A and B is that under Situation B at least one process of the background system or other systems show these large-scale, structural consequences. And only these processes need the different modelling. Typical keywords of Situation B are among others "strategy analysis", "policy development", "concept development", "pervasive technologies", and similar and often in combination with "raw material / energy / XY basis / technology" etc.

### 5.3.6 Guidance for clearly differentiating between Situation A and B

There can be cases, where a study cannot easily be clearly assigned to either Situation A or B.

This is on the one hand the case when a meso-level study of strategic character is affecting a too small part of the market to trigger any large-scale structural consequences in the background system or other systems.

---

<sup>20</sup> For an introduction of 50% bio-fuels in the U.S. diesel fuel, the installed capacity for production of petro-based diesel could reasonably be expected to experience a similar decrease of about 50% (while corrected for economy-wide consumption level changes), as consequence of this potential decision. This could be expected to happen e.g. via changing the product profile of existing crude oil refineries, by closing the least market-competitive refineries, and other measures. Therefore, the LCI modelling also of the petro-based diesel production would need to be changed. In fact, the consequences would also affect the inventory of other refinery products. As however counteracting consequences, an increased export of diesel from the US to other markets could be assumed. Another direct consequence in the above example would be the need of identifying the agricultural land to produce this big amount of additionally required bio-fuel (e.g. by cropping canola in Canada, soybeans in the US, or planting oil palms in Malaysia). Under the assumption that the global demand and hence production for food and other crops would also still to be met, the additionally required land has to come from somewhere else. Also if existing agricultural land would be used for producing bio-fuels, it could be expected that the replaced crops, e.g. wheat for bread baking in the US, would be produced elsewhere. While also intensified production could be assumed to contribute its share to meet the increased demand of agricultural output, an absolute additional need for agricultural land might be identified that would need to be met by converting a certain amount of nature to fields or plantations. This could be both nature land in the U.S. but also in other countries, including the e.g. Brazilian or Malaysian rainforest. This example also illustrates that both e.g. palm oil from Malaysia and e.g. soybean oil from the U.S. could cause - directly or indirectly and to different degrees - the conversion of natural forest into fields or plantations. Note that the above examples and potential consequences are purely illustrative and that a deeper analysis would be required to identify the most likely consequences and scenarios of such a "50% bio fuels in the U.S. diesel fuel" study.

On the other hand, there can be studies on a "product" that are in fact more related to a broader technology, a range of products, or a product group that all further develop and implement this technology and thereby cause large-scale changes on a meso-level (e.g. sector). This can especially happen with rather "narrow" sectors, e.g. of basic materials or energy carriers, where the number of different products (i.e. brands) is far lower than e.g. for most consumer products.

For deciding whether such a study belongs to Situation A or B, the guiding criteria shall be whether the analysed decision implies large-scale consequences in the installed equipment / capacity outside the foreground system of the analysed system that occur via market mechanisms of demand and supply. In that case Situation B applies. In the case of exclusively small-scale consequences on the extent to which existing capacity is used, Situation A applies.

Large-scale ("big") consequences shall generally be assumed if the annual additional demand or supply that is triggered by the analysed decision exceeds the capacity of the annually replaced installed capacity that provides the additionally demanded process, product, or broader function, as applicable; if that percentage is over 5 %, 5 %<sup>21</sup> should be assumed instead. An example: the installed capacity for production of the globally<sup>22</sup> traded material X, that might be required in consequence of the analysed decision to produce product Y, might be e.g. 10 Mio tonnes. The plants for producing material X might have a lifetime of 25 years (i.e. 4 % of this are replaced annually and on average). In that case, an annual demand of more than  $0.04 \cdot 10 \cdot 10^6 \text{ t} = 400,000 \text{ t}$  of material X shall be assumed to have the large-scale consequence of triggering additional installation of capacity beyond the replacement of old plants. This applies analogously to strongly falling markets, as the speed with which equipment is naturally phased out is equally determined by its lifetime.

Next to additional demand, also additional supply (e.g. as co-product from a process of the analysed system) can have large-scale consequences. The above explanations and provisions also applies to cases of multifunctionality and provision of e.g. additional goods or services to a market: if the annually provided amount is larger than the average replacement rate of the installed capacity of the superseded alternative good or service, this falls under Situation B and requires a different modelling. Situation A would not be appropriate, as such big amounts would result in other consequences in the market than merely replacing alternative production; the market could not absorb them without structural changes. An example is the production of rapeseed based biodiesel that results in large amounts of glycerine as co-product that additionally enters the market. This might cause large-scale consequences in other systems, e.g. in this case that existing glycerine production capacity is reduced beyond the age-dependent decommissioning of glycerine plants<sup>23</sup>. In slight difference to additional demand, this relates only to the alternative routes/processes that provide the superseded function.

In the case the additional demand or supply does not relate to a specific process or product (e.g. straw as co-product of rice production) but to a broader function (e.g. dry

---

<sup>21</sup> This acknowledges that the market signal is related to both the equipment replacement rate and the share of market supply that is related to the analysed decision.

<sup>22</sup> For goods almost exclusively traded within one country, the production amount of that country is relevant. For goods traded across countries or in bigger markets, the approximate production amount in the relevant market is the relevant production amount to be considered.

<sup>23</sup> In fact, basically all glycerine plants worldwide have been shut down by now, in response to the large amount of the biodiesel co-produced glycerine.

lignocellulosic biomass), the above applies analogously, covering however all relevant alternative processes / products that provide that function.

Note again that all the above refers to additional demand in the background system and in other systems. Any newly installed capacity in the foreground system does not result in the need of a different LCI model as the foreground system is to be modelled explicitly (via measurement or as explicit scenarios; this is the same for all Situations). Market mechanisms can only act on processes in the background system.

### 5.3.7 Situation C

#### **Terms and concepts: Situation C ("Accounting")**

Purely descriptive accounting / documentation of the analysed system (e.g. a product, need fulfilment, sector, country, etc.) of the past, present or forecasted future, and without implying a decision-context that would account for potential additional consequences on other systems.

Two sub-cases need to be differentiated: In Situation C1 ("Accounting, with system-external interactions"), existing interactions with other systems are included in the LCI model (e.g. considering recycling benefits or avoided production for co-products). Note that these "interactions" refer to existing interactions with other systems only. This is in contrast to the additional consequences<sup>24</sup> that are assumed to occur under Situation A and B, and that are assumed to be caused by the analysed decision. Situation C2 accounts for the analysed system in isolation, i.e. interactions with other systems are not accounted for, but cases of recycling and co-production are solved inside the system model (by allocation)<sup>25</sup>.

The most relevant applications of this goal situation are, for the two sub-types C1 and C2:

#### **Situation C1:**

- Monitoring environmental impacts of a nation, industry sector, product group, or product
- Policy information: Basket-of-products (or -product groups) type of studies
- Policy information: Identifying product groups with the largest environmental impact
- Corporate or site environmental reporting including indirect effects under Environmental Management Systems (EMS)
- Certified supply type studies or parts of the analysed system with fixed guarantees along the supply-chain
- Development of specific, average or generic unit process or LCI results data sets for use in Situation C1

#### **Situation C2:**

<sup>24</sup> Existing / past interactions between systems as depicted in Situation C1 can also be understood as "existing / past consequences" on the background system. This is in contrast to the "additional / future consequences" of Situation A and B. System expansion and substitution could hence also be classified as a third modelling principle "interactional" that has applications in both consequential and attributional modelling. This also explains why system expansion / substitution fits into both the theoretically attributional framework of Situation C1 and the consequential framework of Situations A and B.

<sup>25</sup> In economic modelling, C1 is equivalent to calculating the production cost of the analysed good by subtracting from the total production value the obtainable market prices of all co-products. Situation C2 is equivalent to allocating the production cost among the co-products using other criteria.

- Accounting studies that according to their goal definition do not include any interaction with other systems
- Development of specific, average or generic unit process or LCI results data sets for use in Situation C2

In Situation C, no direct decision is to be made based on the results of the LCA, as the whole life cycle has already been decided before the analysis takes place. I.e. the LCI model is only documenting what has happened (or is going to happen in future during e.g. during the use of long-living products that have already been produced)<sup>26</sup>. From a decision-perspective, the LCI/LCA study is purely retrospective and the results are intended exclusively for accounting-type purposes. Such studies can hence not be used to directly inform e.g. purchase decisions or answer political "what if" scenarios. An example would be the analysis of how various post consumer plastic packaging waste treatment technologies have performed in the past; this can be analysed under Situation C1 or C2. The future performance of these technologies - even if the same technologies are used - depends however also on e.g. how much secondary plastics a technology would produce and which uses exist for these. Hence, for this kind of decision support Situation A or B would apply.

Among accounting / monitoring type studies of Situation C, two cases C1 and C2 need to be differentiated that require a different LCI modelling:

C1: For life cycle based monitoring of e.g. all products of a certain product group that are produced in a certain time-frame (e.g. a given year), the "normal" full life cycle of the products produced in that time-frame is accounted for, i.e. including the measured or forecasted life cycle inventory of the later use and end-of-life stage of the respective amount of these products. An example is the monitoring time-series of the life cycle inventory of e.g. all cars (or: the average car) produced annually in France. This kind of studies belongs to Situation C1. Situation C1 studies can be used to compare the past performance of alternative systems and pointing out the most beneficial alternatives. This however without implying that the result would be the same for the future if a comparative decision was to be made between the alternatives, i.e. one alternative would be purchased or politically promoted and the other not<sup>27</sup>.

C2: For monitoring e.g. of product groups with a system boundary that is strictly referring to a certain time-frame (e.g. a given year), only the interventions that take place in that time-frame are accounted for. An example is the monitoring time-series of all car-related activities (e.g. car production, car use, car recycling, etc.) for the total amount of cars operated in a given year in France. That necessarily leads to a distortion in the life cycle of long-living goods (here: cars), as the goods that are produced in the reference year are inventoried,

<sup>26</sup> One can also model future-related accounting data (e.g. by extrapolating the life cycle data and model basis that has been used for calculating past accounting data). This is however more an extrapolation of past data than an originally future-related accounting model. Much more typical is in any case a backward looking use.

<sup>27</sup> This can be illustrated with a C1-type analysis of rapeseed based biodiesel production in the year 1990, crediting the co-product glycerine with the avoided alternative petro-based glycerine production. In that year 1990, the co-product glycerine was entirely absorbed by the market and thereby has avoided petro-based glycerine production. This is however not necessarily the case when now promoting rapeseed based biodiesel e.g. by setting the political goal in the U.S. of e.g. 20% of the national diesel production to be biodiesel: the huge amounts of additional glycerine that would result cannot be absorbed by the market in the same way as a small amount could be - the demand is not big enough. The glycerine might even potentially be waste instead of a co-product. The results of the study performed as Situation C1 would hence misinform the policy. If hence the aim of the study would be to analyse the environmental impact of **additional** biodiesel production, that study would have to be performed as Situation A or B study, depending on the scale of production and related consequences.



while the inventoried use-stage emissions are those of the e.g. cars used in that year, i.e. including all those still operated older cars with potentially lower emission standards. At the same time does this kind of inventorying not account for the past production of the cars that are operated in the given time-frame and not for the future use and recyclability of the cars produced in that year. Apart from difficulties in interpreting the results of such indicators, this kind of studies belongs to Situation C2.

Another example are studies that aim at providing accounting type of information, where a change in demand does not affect the background system in a consequential manner, but via established supply-chain agreements, requiring to model the supply-chain as Situation C1. Certification of wood products is an example where the supply-chain steps of using XY certified wood would be fixed / guaranteed<sup>28</sup>, including in the background system<sup>29</sup>.

At the same time, accounting data, especially under Situation C1, informs decision and policy makers about developments e.g. related to a region as a whole or e.g. for specific service / activity groups (such as e.g. housing, individual mobility, food, etc.). This can be also in a comparative manner (e.g. when comparing the environmental impact potential of an average citizen across countries). Such data can for example also show which share different e.g. housing types (e.g. flats in high-rise buildings, single family houses, etc.) have in the overall national housing impact, per m<sup>2</sup>, or per citizen. Accounting studies hence identify unwanted developments or show the achievements made based on implemented decisions or policies. However, to develop policy measures or support other decisions, other LCI modelling methods are to be employed: those used under Situation A or B.

Typical keywords of Situation C LCI/LCA studies are "accounting", "monitoring", "retrospective", "documentation", etc. in relation to "product", "basket-of-products", "needs fulfilment", "sector", "country", "average citizen", etc.

### 5.3.8 Guidance for clearly differentiating between Situation C and A / B

It is important to clearly differentiate whether a comparative decision support is to be supported by the study, i.e. whether the study and data shall inform which of compared alternatives is to be preferred because of better environmental performance.

Often studies are labelled "Monitoring" while they nevertheless involve decision support questions and directly imply recommendations and/or policy measures and belong hence under Situation A or B.

Other studies aim at describing systems including their external benefits but without intending to make recommendations, support purchase decisions, or directly derive policy measures from them: E.g. "Monitoring of waste management systems in different Eastern Europe countries" may aim at identifying which waste management systems have been most or least environmentally advantageous. This question implies that e.g. credits for recovered energy and recycled materials should be given to the analysed systems to capture their

---

<sup>28</sup> See however chapter 6.8.2 on the restriction on non-scalable processes, e.g. hydropower in some countries, where the specific supply cannot be extended and the market mix is to be used. This would also apply here, if the potential of XY certified wood would be relevantly restructured and not scalable to a relevant degree to meet an additional demand.

<sup>29</sup> A certification example where this does not work is a certification system that only relates to the direct supplier, but not all the way into the background system.

comparative performance. This study is however not automatically implying direct e.g. policy measures and hence belongs to Situation C1.

Situation C1 lies hence between A/B and C2, being retrospective but accounting for benefits on other systems e.g. via co-products and recycling. In practice, a larger number of accounting-type studies can be found that belong to Situation C1.

In other cases it might be the explicit interest to provide accounting type life cycle information (e.g. for a product, site, etc.) without including existing interactions with other systems. In that case Situation C1 applies. The accounting character of these studies shall be stated explicitly in the goal of the study and the restrictions for decision support and comparisons the study has are to be clarified in the reporting.

### Provisions: 5.3 Classifying the decision-context

Applicable to Situation A, B, and C, differentiated.

- 1) **SHALL - Identify applicable goal situation:** Identify the type of decision-context of the LCI/LCA study, i.e. to which of the archetypal goal situations A, B, C1, or C2 the study belongs. Draw on the goal aspects "intended applications" (chapter 5.2.1) and "specific decisions to be supported" (chapter 5.2.3)), as follows: [ISO!]
  - 1.a) **Situation A - "Micro-level decision support":** Decision support, typically at the level of products, but also single process steps, sites/companies and other systems, with no or exclusively small-scale consequences in the background system or on other systems. I.e. the consequences of the analysed decision alone are too small to overcome thresholds and trigger structural changes of installed capacity elsewhere via market mechanisms<sup>30</sup>. Situation A covers among others the LCA applications listed below; any deviating assignment to another goal situation than A shall be justified and be in line with the above provisions (see also the specific provisions below for differentiating between Situation A and B, and between Situation C and A/B):
    - Identification of Key Environmental Performance Indicators (KEPI) of a product group for Ecodesign / simplified LCA
    - Weak point analysis of a specific product
    - Detailed Ecodesign / Design-for-recycling
    - Perform simplified KEPI-type LCA / Ecodesign study
    - Comparison of specific goods or services
    - Benchmarking of specific products against the product group's average
    - Green Public or Private Procurement (GPP)
    - Development of life cycle based Type I Ecolabel criteria
    - Development of Product Category Rules (PCR) or a similar specific guide for a product group
    - Development of a life cycle based Type III environmental declaration (e.g.

<sup>30</sup> Note that these small-scale consequences shall not be interpreted, as *per se* resulting in large-scale consequences on installed capacity, i.e. shall be covered under Situation A.

Environmental Product Declaration (EPD)) for a specific good or service

- Development of the 'Carbon footprint', 'Primary energy consumption' or similar indicator for a specific product
- Greening the supply chain
- Providing quantitative life cycle data as annex to an Environmental Technology Verification (ETV) for comparative use
- Clean Development Mechanism (CDM) and Joint Implementation (JI)
- Development of specific, average or generic unit process or LCI results data sets for use in Situation A

I.b) **Situation B - "Meso/macro-level decision support"**: Decision support for strategies with large-scale consequences in the background system or other systems. The analysed decision alone is large enough to result via market mechanisms in structural changes of installed capacity in at least one process outside the foreground system of the analysed system. Situation B covers among others the LCA applications listed below; any deviating assignment to a goal situation other than B shall be justified and be in line with the above provisions (see also the specific provisions below for differentiating between Situation A and B and between Situation C and A/B):

- Policy development: Forecasting & analysis of the environmental impact of pervasive technologies, raw material strategies, and related policy development
- Policy information: Identifying product groups with the largest environmental improvement potential
- Development of specific, average or generic unit process or LCI results data sets for use in Situation B

It is important to note that the LCI modelling provisions for Situation B (see chapter 6.5.4.3) refer exclusively to those processes that are affected by these large-scale consequences. The other parts of the background system of the life cycle model will later be modelled as "Situation A", i.e. typically all the processes with a smaller contribution to the overall results.

I.c) **Situation C - "Accounting"**: From a decision-making point of view, a retrospective accounting / documentation of what has happened (or will happen based on extrapolating forecasting), with no interest in any additional consequences that the analysed system may have in the background system or on other systems. Situation C has two sub-types: C1 and C2. C1 describes an existing system but accounts for interactions it has with other systems (e.g. crediting existing avoided burdens from recycling). C2 describes an existing system in isolation without accounting for the interaction with other systems. This may cover the LCA applications listed below; any deviating assignment to a goal situation other than C1 or C2 shall be justified and be in line with the above provisions. See also the specific provision below for differentiating between Situation C and A/B:

I.c.i) **Situation C1 - "Accounting with interactions"**:

- Monitoring environmental impacts of a nation, industry sector, product group, or product
- Policy information: Basket-of-products (or -product groups) type studies

- Policy information: Identifying product groups with the largest environmental impact
- Corporate or site environmental reporting including indirect effects under Environmental Management Systems (EMS)
- Certified supply type studies or parts of the analysed system with fixed guarantees along the supply-chain
- Development of specific, average or generic unit process or LCI results data sets for use in Situation C1

**I.c.ii) Situation C2 - "Accounting without interactions":**

- Accounting studies that according to their goal definition do not include any interaction with other systems
- Development of specific, average or generic unit process or LCI results data sets for use in Situation C2

Note that any decision support that would be derived needs to employ the methods under Situation A or B, with Situation C having a preparatory role only. Note however that due to the simplified provisions of this document, the modelling of Situation A studies (micro-level decision support) is identical to that of Situation C1 studies, but not vice versa.

- II) **SHALL - Situation A or B:** Where a study cannot initially be clearly assigned to either Situation A or B, for example when analysing major strategies of market-dominating companies or product-related questions of market-dominating products. In this situation, the guiding criteria shall be whether the consequences of the analysed decision alone are big enough to overcome related thresholds and/or other constraints and result in large-scale consequences in the installed production capacity outside the foreground system. Then: Situation B. If not: Situation A. Large-scale consequences shall generally be assumed if the annual additional demand or supply, triggered by the analysed decision, exceeds the capacity of the annually replaced installed capacity of the additionally demanded or supplied process, product, or broader function, as applicable. If that percentage is bigger than 5 %, 5 % should be used instead. [ISO!]
- III) **SHALL - Situation C1 or A/B:** In the case a study cannot initially be clearly assigned to either Situation C1 or A/B, for example when it is a monitoring study but involves a comparative decision support. In this situation the guiding criteria shall be whether a comparative decision support is to be given by the LCI/LCA study, i.e. whether the study shall be used to support decisions on alternatives with better or worse environmental performance. Then Situation A or B applies, depending on small-scale or large-scale consequences; see related provisions. If not, i.e. the study is only retrospectively informing about better performance in the past, then Situation C applies. [ISO!]

Table 3 maps widely used LCA applications to the required study deliverables and the corresponding goal situation A, B, or C.

Chapter 6.5.4 provides the overview of the LCI modelling provisions for Situation, A, B, and C.

Figure 3 provides an overview on which chapters of this document identify the detailed modelling differences for Situations A, B, and C.

## 5.4 Need for flexibility versus strictness

Independently from the specific goal situation, other aspects of the intended applications determine whether more methodological flexibility is required or whether strictness / reproducibility is key: as one extreme, in Situation A, the development of an Environmental Product Declaration (EPD) or of a Carbon footprint indicator require a very high degree of strictness to enable a high degree of reproducibility and thereby sufficient comparability of the results for competing products. As the other extreme, in Situation B, comparative assertions of policy options for different future raw materials strategies (e.g. biofuels vs. fossil fuels) need to work with extensive scenario analysis including of the LCI method principles and approaches to ensure the robustness of the conclusions and recommendations.

That means that especially for Situation A, a further narrowed down and specified guidance would be beneficial. Such would need to interpret the general guidance as laid down in this document from the perspective of the types of processes and products to be modelled. It would convert the generic Provisions into more specific Provisions.

Such product-group or process-type specific guidance documents, e.g. in form of Product Category Rules (PCRs) are hence seen as beneficial for further improving the reproducibility of studies done under Situation A. The development of such PCR-type guidance documents is a subsequent step and potentially to be lead by the respective industry sectors.

To ensure consistency with the provisions of this present guidance and the other ILCD guidance documents, the critical review of such PCR-type documents is covered in the separate document "Review schemes for LCA".

### Provisions: 5.4 Need for flexibility versus strictness

- I) **SHALL - Product-group and process-type specific guides and PCRs: [ISO+]**
  - I.a) **Need for specific guides and PCRs:** To further the reproducibility of LCI/LCA studies, the development of ILCD-compliant sector, product-group or process-type specific guidance documents and/or Product Category Rules (PCR) is recommended. A specific guide or PCR is ILCD-compliant in its provisions, if these are in line (i.e. not contradicting) with the provisions of this document and other referenced ILCD Handbook documents. They can therefore be stricter or more specific, but not less.
  - I.b) **Specific guides and PCRs overrule ILCD Handbook:** If such guides or PCRs have been developed and approved in an ILCD-compliant review process, the provisions in these guides or PCRs shall be applied for the product-groups and process-types they cover. Therefore, they overrule the broader provisions of the ILCD Handbook. See also chapter 2.3.

The document "Review schemes for LCA" provides information on the applicable review type. The forthcoming specific documents on "Reviewer qualification" and "Review scope, methods and documentation" for product-group and process-type specific guides and PCRs give the complementary requirements.

## 5.5 Optionally extending the goal

(No corresponding ISO 14044:2006 chapter)

The foreseen goal of the LCI/LCA study may be extended to include additional applications of secondary interest, e.g. development of an Environmental Product Declaration (EPD) for business customers using the same life cycle model that will be developed for in-house benchmarking, weak point analysis, and/or use in product improvement / ecodesign, etc. or *vice versa*. This extension of the goal should be done initially, as it then typically means little additional effort, while a later expansion might require substantial additional resources for collection of missing or too coarse data or the need to re-model the system differently (e.g. with parameters).

### Provisions: 5.5 Optionally extending the goal

- 1) **MAY - Extending the goal?:** Consider extending the goal to further uses / applications of the LCI/LCA study in order to benefit from synergies. [ISO+]

## 6 Scope definition - what to analyse and how

(Refers to ISO 14044:2006 chapter 4.2.3)

### 6.1 Introduction and overview

(Refers to ISO 14044:2006 chapter 4.2.3.1)

During the scope definition phase the object of the LCI/LCA study (i.e. the exact product or other system(s) to be analysed) is identified and defined in detail. This shall be done in line with the goal definition. Next and main part of the scope definition is to derive the requirements on methodology, quality, reporting, and review in accordance with the goal of the study, i.e. based on the reasons for the study, the decision-context, the intended applications, and the addressees of the results.

When deriving the scope of an LCI/LCA study from the goal, the following scope items shall be clearly described and/or defined:

- The type(s) of the deliverable(s) of the LCI/LCA study, in line with the intended application(s) (chapter 6.3)
- The system or process that is studied and its function(s), functional unit, and reference flow(s) (chapter 6.4, which names case-specific provisions)
- LCI modelling framework and handling of multifunctional processes and products (chapter 6.5)
- System boundaries, completeness requirements, and related cut-off rules (chapter 6.6)
- LCIA impact categories to be covered and selection of specific LCIA methods to be applied as well as - if included - normalisation data and weighting set (chapter 6.7)
- Other LCI data quality requirements regarding technological, geographical and time-related representativeness and appropriateness (chapter 6.8)
- Types, quality and sources of required data and information (chapter 6.9), and here especially the required precision and maximum permitted uncertainties (chapter 6.9.2)
- Special requirements for comparisons between systems (chapter 6.10)
- Identifying critical review needs (chapter 6.11)
- Planning reporting of the results (chapter 6.12)

The procedure is described in more detail in the further subchapters.

The order of the subchapters follows the main LCA workflow logic. At the same time the interrelatedness of some items and the iterative nature of LCA limits this somewhat.

In the subsequent iterations the initial scope definition of the LCI/LCA study (and in some cases even the goal) often is to be fine-tuned or even revised due to unforeseen limitations or constraints or as a result of other additional information. The final documentation of the LCI/LCA study shall reflect this, including the consequence for the achieved levels of completeness, precision, accuracy, etc. and intended applications.

Before addressing the different aspects of the scope definition in more detail, two crosscutting requirements on LCA will be briefly addressed. Note that these require being explicitly checked and referred to in the sub-sequent work and be documented:

- Consistency of methods, assumptions, and data (chapter 6.2.1)
- Reproducibility (chapter 6.2.2)

## 6.2 Overview and basic requirements

(Refers to ISO 14044:2006 chapter 4.2.3.1)

### 6.2.1 Consistency of methods, assumptions, and data

(Refers to aspect covered under ISO 14044:2006 chapter 4.2.3.6.2)

An important underlying requirement in LCA is to ensure sufficient consistency of methods and assumptions as well as data throughout the LCI/LCA study. This relates to all phases and aspects of LCA work and is a prerequisite for validity of results and appropriateness of any comparison.

The following is to be kept in mind throughout all steps of the scope phase:

- In order to ensure the quality of the results, all assumptions shall be made in a consistent way for the different parts of the analysed system (e.g. whether energy calculations use the upper or lower calorific value). The used LCI data shall also be consistent across the system to the extent required to meet the overall necessary accuracy, completeness and precision of the study (as to be identified in chapter 6.9.2). For comparisons e.g. of products this means among others that the same product use patterns are assumed, that the same life cycle stages are included, that the inventory data has approximately the same degree of accuracy and precision, etc.
- Likewise, the application of all methods (e.g. for estimating emissions from unit processes or for calculating impacts from these emissions in the impact assessment) shall be foreseen to be done in a uniform way throughout the study and in accordance with the goal and scope definition. In particular it shall be ensured that the life cycle is modelled applying the same methodological provisions (e.g. as defined for Situation A) and uses the same elementary flow nomenclature throughout the whole system model and also across all compared systems in case of comparative studies. This applies to both all the background data set and the specific foreground data that will be collected (see chapter 6.9). This equally implies that the same LCIA methods (e.g. impact indicators, spatial and/or time differentiation, etc.) shall be applied for all systems in comparative studies (see chapter 6.7).
- Foresee that any inconsistencies of the above shall be documented and should be demonstrated / justified as being insignificant for the environmental impact results of the system(s). If this insignificance cannot be shown, this shall be explicitly considered when stating the achieved quality (in case of an LCI or LCIA data set or study) or drawing the conclusions and recommendations (in case of an LCA study).

In summary: during scope definition and in the later inventory and impact assessment phases, efforts must be made to ensure a high degree of consistency regarding all important methodological and data aspects of the LCA and for all relevantly contributing processes of the system. The actually achieved consistency is to be checked as part of the evaluation step in the interpretation phase (see chapter 9.3) and is to be considered in drawing conclusions and recommendations and in communication.

#### Provisions: 6.2.1 Consistency of methods, assumptions and data

Applicable to all types of deliverables, implicitly differentiated.

- 1) **SHALL - Methods and assumptions consistency:** All methods and assumptions shall be applied in a sufficiently consistent way to all life cycle stages, processes,



parameters, and flows of the analysed system(s), including across foreground and background system(s) as required in line with the goal of the study. This also applies to LCIA methods and factors and normalisation and weighting, if included.

- II) SHALL - **Data consistency:** All LCI data shall be sufficiently consistent regarding accuracy, precision, and completeness, in line with the goal of the study.
- III) SHALL - **Dealing with inconsistencies:** Any inconsistencies of the above shall be documented. The inconsistencies should be insignificant for the environmental impact results of the analysed system or, for LCA studies, for the conclusions and recommendations drawn. Otherwise, this should result in revising the goal settings or the inconsistencies shall be explicitly considered when later reporting the achieved quality (in case of an LCI or LCIA data set or study<sup>31</sup>) or drawing the conclusions and recommendations (in case of an LCA study).

## 6.2.2 Reproducibility

(Refers to aspect covered under ISO 14044:2006 chapter 4.2.3.6.2)

Reproducibility is another important requirement for LCA that shall be met: the achieved reproducibility of an LCI/LCA study is a qualitative assessment in how far the documented methods, assumptions, and data / data sources would allow an independent practitioner to sufficiently reproduce the results of the LCI/LCA study and any conclusions or recommendations drawn. This is important for the credibility of the LCI/LCA study and an important item for review.

A good reproducibility of LC/LCA studies is supported by a clear guidance for the LCA work (e.g. the one defined in the ILCD Handbook), by applying it in a consistent and transparent way, and by documenting this appropriately in the report of the study and/or data set. The ILCD LCA report template and LCI reference data set format support an appropriate and efficient technical documentation for informing expert users and reviewers and for being a starting point and reference to develop communication means for non-technical audience.

In many cases of published LCI/LCA studies, there is a need to balance the reproducibility and confidentiality. An independent and external critical review of the data is the suitable means to guarantee data quality of LCI data sets and the robustness / reproducibility of the results of comparative LCA studies, while equally meeting confidentiality needs: Public transparency on all data and parameters should be provided as far as confidentiality allows for it. If public transparency is not possible, the evaluation of the reproducibility shall be supported via giving confidential access to the confidential information (typically unit process and/or raw data, as well as related assumptions and parameters) exclusively to the critical reviewer(s). Public access shall be given in any case to the appropriate meta-documentation of the modelled system(s) including on applied LCI and LCIA methods, the main data sources used, relevant assumptions and limitations made, etc.

For comparative LCA studies, the LCI results and LCIA results shall always be public, i.e. cannot be exclusively put into the confidential report.

---

<sup>31</sup> See 6.3 for different types of deliverables of an LCI/LCA study.

### Provisions: 6.2.2 Reproducibility

- I) **SHALL - Documentation for reproducibility:** Documentation of the methods, assumptions and data / data sources used in the LCI/LCA study (see chapter 10) shall be appropriate and transparent to the extent that would enable another LCA practitioner to sufficiently reproduce the results.
  - I.a) In the case of an LCI or LCIA data set or study<sup>31</sup>, this refers to the LCIA results.
  - I.b) In the case of an LCA study, this refers to any conclusions or recommendations drawn.
- II) **MAY - Accompanying documentation process:** It is recommended to begin the documentation from the beginning of the project, electronically or on paper, and guided by the final need for reporting, and to revise / fine-tune the initial documentation over the course of the study. [ISO+]
- III) **SHALL - Confidential information:** For underlying confidential or proprietary data and information that cannot be published, a separate confidential report may be foreseen. This report shall be made available to the critical reviewer(s) under confidentiality (in case a critical review is required or anticipated). See also chapter 10.3.4.

Note: The separately available LCA report template and LCI data set format support an appropriate and efficient technical documentation for informing expert users and reviewers. It is a starting point and reference to develop communication for a non-technical audience. [ISO+]

## 6.3 Types of LCI and LCA deliverables and intended applications

(No corresponding ISO 14044:2006 chapter)

The appropriate type of deliverable is derived from the goal of the LCI/LCA study, especially the intended applications. This is unless the type is already directly specified in the goal. This step is typically done very early in the scope definition, as the necessary depth and the width of LCI/LCA study can differ considerably among the types. In ISO 14044:2006 this issue is addressed only implicitly throughout the standard; there is hence no clear corresponding chapter in ISO 14044:2006.

The most commonly used possible types of deliverables are as follows from the basic to the more comprehensive ones:

- Life Cycle Inventory ("LCI") study and/or data set, in the following variants:
  - Unit process study and/or data set, with two sub-types (concept see Figure 7):
    - Single operation unit process (variants: fixed or parameterised)
    - Black box unit process (variants: fixed or parameterised)
  - Partly terminated system data set (variants: fixed or parameterised)
  - Life Cycle Inventory results ("LCI results") study and/or data set
- Life Cycle Impact Assessment results ("LCIA results") study and/or data set
  - Non-comparative Life Cycle Assessment study ("LCA study"), i.e. including impact assessment and interpretation

- Comparative Life Cycle Assessment study ("Comparative LCA study"), in the following variants:
  - Non-assertive comparative Life Cycle Assessment study ("Non-assertive comparative LCA study")
  - Comparative assertion Life Cycle Assessment study ("Comparative assertion LCA study"), with superiority, inferiority or equality of any compared alternatives are explicitly concluded
- Detailed LCI model of the analysed system (if more detailed scenario analysis is intended (e.g. in detailed ecodesign)).

Note: For studies that develop LCIA models, methods and factors see the separate guidance document "Framework and requirements for Life Cycle Impact Assessment (LCIA) models and indicators".

Table 3 gives an overview, which type(s) of deliverables of the LCI/LCA study are required as input for each of the intended application<sup>32</sup>. It also shows to which of the three archetypal goal situations each intended application typically belongs and which specific ISO standard relates to that type of deliverable, if any.

The required form of reporting depends on several factors; next to the type of deliverable and the intended applications also e.g. the addressees influence this; the related detailed provisions are found in chapter 10.

---

<sup>32</sup> All LCA studies ultimately go back to unit processes and beyond that to the original measurements or modelling of the process emissions etc. However, the kind of LCI/LCA deliverable that is to be developed as direct starting point for the named LCA application can be e.g. an LCA study, an LCI results data sets, a product-groups specific KEPI-based tool, etc. LCI results and unit process data sets are also always interim steps of any specific LCA study. Note that typically a range of other information and data, specific software tools, as well as specific expertise and experience is required, of course. This is not further detailed here as out of the scope of this document.

**Table 3 Most common types of LCI/LCA study deliverables required for specific LCA applications (indicative overview). The most suitable ones are to be decided upon depending on the specific case.**

Application areas / Purposes	LCA applications (from perspective of life cycle information user or provider)	LCI / LCA type of deliverable and / or application required as direct input for the "LCA application" <sup>33, 34, 35</sup>	Applicable goal situation	Related ISO standard (next to 14040 and 14044:2006)
Product improvement	<b>Identification of Key Environmental Performance Indicators (KEPI) of a product group for Ecodesign / simplified LCA</b>	<b>d or e or iii; and f</b>	<b>A</b>	
	<b>Weak point analysis of a specific product</b>	<b>f and <u>d</u></b>	<b>A</b>	<b>ISO/TR 14062</b>
	<b>Detailed Ecodesign / Design-for-recycling</b>	<b>f</b>	<b>A</b>	<b>ISO/TR 14062</b>
	<b>Perform simplified KEPI-type LCA / Ecodesign study</b>	<b>i</b>	<b>A</b>	
Product comparisons and procurement	<b>Comparison of specific goods or services</b>	<b><u>e</u>, ii, or iv</b>	<b>A</b>	
	<b>Benchmarking of specific products against the product group's average</b>	<b><u>e</u></b>	<b>A</b>	
	<b>Green Public or Private Procurement (GPP)</b>	<b><u>e</u>, ii, or iv</b>	<b>A</b>	<b>ISO 14015</b>
Communication	<b>Development of life cycle based Type I Ecolabel criteria</b>	<b>d, e, i, or iii</b>	<b>A</b>	<b>ISO 14024</b>

<sup>33</sup> Basic type as input for LCA application: **a** = Unit process data set; **b** = LCI results data set; **c** = LCIA results data set; **d** = LCA study, non-comparative; **e** = Comparative LCA study; **f** = Detailed LCI model of system. Application as input for other LCA applications: **i** = KEPIs-based tool; **ii** = EPD; **iii** = Criteria set for life cycle based Type I Ecolabel; **iv** = Life cycle based Type I Ecolabel of the system.

<sup>34</sup> Several LCA applications typically use at least alternatively the outcome of other LCA applications as input, e.g. Green Procurement often works with KEPI or Type I Ecolabel criteria. This is additionally indicated in the table.

<sup>35</sup> Note that LCA studies (d and e) as basic form of application can already directly provide the required LCA application, e.g. a weak point analysis of the specific product or the comparison of products in support of procurement. In that case the letters **d** and **e** are **underlined**.

Application areas / Purposes	LCA applications (from perspective of life cycle information user or provider)	LCI / LCA type of deliverable and / or application required as direct input for the "LCA application" <sup>33, 34, 35</sup>	Applicable goal situation	Related ISO standard (next to 14040 and 14044:2006)
	<b>Development of Product Category Rules (PCR) or a similar specific guide for a product group</b>	<b>e or d; and f</b>	<b>A</b>	<b>ISO 14025</b>
	<b>Development of a life cycle based Type III environmental declaration (e.g. Environmental Product Declaration (EPD)) for a specific good or service</b>	<b>d or i; and f</b>	<b>A</b>	<b>ISO 14025</b>
	<b>Development of the 'Carbon footprint', 'Primary energy consumption' or similar indicator for a specific product</b>	<b><u>d</u>, i, or f</b>	<b>A</b>	<b>ISO 14025</b>
	<b>Calculation of indirect effects in Environmental Management Systems (EMS)</b>	<b>b or <u>d</u></b>	<b>C1</b>	<b>ISO 14001</b>
	<b>Greening the supply chain</b>	<b>ii, iv, or e</b>	<b>A</b>	<b>ISO 14015</b>
	<b>Providing quantitative life cycle data as annex to an Environmental Technology Verification (ETV) for comparative use</b>	<b>ii, <u>d</u>, or i</b>	<b>A</b>	
Across several areas	<b>Development of specific, average or generic unit process or LCI results data sets for use in different applications</b>	<b>a or b</b>	<b>A, B, C1, or C2</b>	
	<b>Clean Development Mechanism (CDM) and Joint Implementation (JI)</b>	<b>d, ii, i, or f</b>	<b>A</b>	
Strategic decision support	<b>Policy development: Forecasting &amp; analysis of the environmental impact of pervasive technologies, raw material strategies, etc. and related policy development</b>	<b><u>e</u></b>	<b>B</b>	
	<b>Policy information: Identifying product groups with the largest environmental improvement potential</b>	<b><u>e</u></b>	<b>B</b>	

Application areas / Purposes	LCA applications (from perspective of life cycle information user or provider)	LCI / LCA type of deliverable and / or application required as direct input for the "LCA application" <sup>33, 34, 35</sup>	Applicable goal situation	Related ISO standard (next to 14040 and 14044:2006)
Accounting	<b>Monitoring environmental impacts of a nation, industry sector, product group, or product</b>	<u>d</u> or b	C1	
	<b>Policy information: Basket-of-products (or -product groups) type of studies</b>	<u>e</u>	C1	
	<b>Policy information: Identifying product groups with the largest environmental impact</b>	<u>e</u>	C1	
	<b>Certified supply type studies or parts of the analysed system with fixed guarantees along the supply-chain</b>	b, <u>d</u> , e, or ii	C1	
	<b>Corporate or site environmental reporting</b>	<u>d</u>	C1	ISO 14015, ISO 14031
	<b>Accounting studies that according to their goal definition do not include any interaction with other systems</b>	<u>d</u>	C2	

### Provisions: 6.3 Types of LCA deliverables and intended applications

Applicable to Situation A, B, and C, differentiated.

- I) **SHOULD - Types of deliverables:** Derive from the intended application(s) identified in the goal definition (see chapter 5.2.1) and any potential pre-settings, the appropriate type(s) of deliverable(s) that the LCI/LCA study should provide. Table 3 gives an overview. The following types are most common, listed in order of increasing comprehensiveness and/or complexity: [ISO!]
  - I.a) Life Cycle Inventory ("LCI") study and/or data set, in the following variants:
    - I.a.i) Unit process study and/or data set, with two sub-types:
      - I.a.i.1) Single operation unit process (variants: fixed or parameterised)
      - I.a.i.2) Black box unit process (variants: fixed or parameterised)
    - I.a.ii) Partly terminated system data set (variants: fixed or parameterised)
    - I.a.iii) Life Cycle Inventory results ("LCI results") study and/or data set
  - I.b) Life Cycle Impact Assessment results ("LCIA results") study and/or data set
  - I.c) Non-comparative Life Cycle Assessment study ("LCA study"), i.e. including impact assessment and interpretation
  - I.d) Comparative Life Cycle Assessment study ("Comparative LCA study"), in the following variants:
    - I.d.i) Non-assertive comparative Life Cycle Assessment study ("Non-assertive comparative LCA study")
    - I.d.ii) Comparative assertion Life Cycle Assessment study ("Comparative assertion LCA study"), with superiority, inferiority or equality of any compared alternatives are explicitly concluded
  - I.e) Detailed LCI model of the analysed system

Note that the different types of deliverables imply different requirements e.g. regarding reporting and review.

Note: For development of LCIA models, methods and factors as a special kind of LCA deliverable see the separate guidance document "Framework and requirements for Life Cycle Impact Assessment (LCIA) models and indicators". [ISO+]

## 6.4 Function, functional unit, and reference flow<sup>36</sup>

(Refers to ISO 14044:2006 chapter 4.2.3.2 and aspects of 4.2.3.3.1)

### 6.4.1 Detailed identification of the process(es) or system(s) to be analysed

(Refers to aspects of ISO 14044:2006 chapters 4.2.3.2 and 4.2.3.3.1)

Based on the initial information on the process(es) or system(s) to be analysed given in the goal definition, details often need to be added in the scope definition. Especially when the goal of the LCI/LCA study is of a less specified nature (e.g. "Comparative assertion on

<sup>36</sup> A detailed example of function, functional unit, reference flow etc. is found in chapter 6.4.4.

market prevailing packaging options for fresh vegetables in the UK"), the to-be-analysed and compared systems (here: the specific packaging options) still need to be identified and specified in detail. This shall be done in the scope phase of the LCI/LCA study. The need for such a better specification in the scope definition is always found when the goal relates to e.g. "generic", "average", "concept" or other insufficiently defined characteristics that need interpretation.

This system specification closely interrelates with the system(s)'s function(s), its functional unit(s), and its reference flow(s):

### **Terms and concepts: Function, functional unit, and reference flow**

The system's function and functional unit are central elements of an LCA. Without them, a meaningful and valid comparison especially of products is not possible:

An LCA is always anchored in a precise, quantitative description of the function(s) provided by the analysed system (e.g. "covering an outdoor wall against the weather, etc."). Note that also study objects such as analysed policy option or a strategy, or whole countries that are monitored with LCA-based indicators have a 'function'; in the sense of an LCA function means to quantitatively and qualitatively specify the analysed object:

This is generally done by using the functional unit that names and quantifies the qualitative and quantitative aspects of the function(s) along the questions "what", "how much", "how well", and "for how long". For a product this could be e.g. "Complete coverage of 1 m<sup>2</sup> primed outdoor wall for 10 years at 99.9 % opacity"). For a policy option this applies analogously. To make it clearer, the following examples splits the four aspects: it could be e.g. a product policy setting minimum requirements (i.e. "how much and "how well") on all products of product group X that are sold in the U.S. market (i.e. "what"), from 2012 onwards until policy revision in 5 years (i.e. "how long"). For a country indicator this would be e.g. all goods and services that contribute to mobility (i.e. "what") in South Korea (i.e. "how much"), for one year for the baseline year 2006 (i.e. "how long"). The "how well" would be part of the definition of mobility (e.g. is walking included). Key is that the functional unit allows to make comparisons that are valid, as the compared objects (or time series data on the same object) are comparable. These definitions and quantification of the functional unit often draw on technical measurement standards.

The reference flow, finally, is the flow (or flows in case of multifunctional processes) to which all other input and output flows (i.e. all elementary flows and non-reference product and waste flows) quantitatively relate. It is realising the functional unit: The reference flow can be expressed in direct relation to the functional unit (e.g. "Complete coverage of 1 m<sup>2</sup> primed outdoor wall for 10 years at 99.9 % opacity with paint A") or in a more product-oriented way (e.g. "0.67 l paint A"). The choice of the preferred type of reference flow depends firstly on the kind of product: for products with only one relevant function both options are possible. For products with several alternative functions (e.g. "1 kg steel-sheet; type XY...") it is more useful to use a measured amount (e.g. mass in kg) of the product with its technical specification as reference flow instead of a reference flow related to a specific functional unit measured e.g. in m<sup>2</sup>, as that can complicate other uses of the data set. Note that also the modelling logic of the used LCA software can require or prefer using one of the two, depending on their flexibility to connect processes with differently named reference flows.

Note that one aspect of both the functional unit and the reference flow is the location (and type of location) where a product is available. E.g. the location "in Germany" / "DE" and "1 l beverage carton packed fresh milk at point of sale" or "... to consumer", i.e. identifying as location type which transport and/or storage steps are included in the inventory. This is to be



identified as part of the reference flow name, unless the data set refers to a location unspecific process step (e.g. "High pressure injection moulding machine for HD-PE, etc.").

For more on the quantitative and qualitative aspects of the functional unit see chapters 6.4.2 and 6.4.3 and the example in chapter 6.4.4.

It is recommended to also provide a detailed description of the analysed system plus photos (especially in case of consumer products).

Often the goal of the LCI/LCA study determines which of its single functions will be in focus and what will be the analysed object, or whether the whole system is object of the analysis: e.g. can a waste incineration plant be looked at from waste management perspective, making just one of the individual household waste components (e.g. polymer fraction, inert materials, organic biomass fraction, etc.) to its reference flow and functional unit<sup>37</sup>. If a data set "electricity from household waste incineration" would be required, the produced electricity would be set as reference flow. If, in a third perspective, a detailed analysis of the incineration plant is goal of the LCI/LCA study, the plant as a whole would be targeted and technically specified and potentially also parameterised instead of defining any specific functional unit.

## 6.4.2 Quantitative aspects of the functional unit

(Refers to aspects of ISO 14044:2006 chapter 4.2.3.2)

First step of defining the functional unit is to identify and quantify the relevant quantifiable properties and the technical / functional performance of the system. An example for a good is a shopping bag of which the strength, volume, and other properties would be relevant quantitative aspects. But also how often the bag can be used (or is used based on surveys) is important. For services the example of cleaning services would give the floor type and area cleaned (to a given specification of cleanliness). Note that although here the quantitative properties are addressed these always necessarily also relate to a certain quality; however they are and can be quantified.

For quantifying the functional unit of many products, two aspects of the extent of the provided function are to be differentiated: the duration of use (in time) and the extent/quantity of actual function provided. An example: a car may have an average lifetime of 12 years. However, for the comparison with other car models, the lifetime in terms of driven km are the more suitable, i.e. functional information. For products with continued function (such as e.g. housing, fridges) this case does not apply typical, but wherever the use intensity plays a dominant role, the choice of the appropriate functional unit becomes crucial. The same applies for e.g. clothes, mobile phones, TV sets, etc. where the duration that the product is kept in possession before discarding it is not suitable for comparisons. While this information might be important for issues such as carbon storage or for identifying the time horizon when recycling takes place (e.g. mobile phones are often kept for many years in possession after end of use, as waste management requirements are unclear and the product does not need much space).

---

<sup>37</sup> It is equivalent to use an e.g. „organic waste fraction“ waste flow as reference flow or the „organic waste fraction treatment“ product flow. The choice has however influence on how the product system will be modelled, as in the first option (that follows a “process flow” logic) the waste flow would be an input flow to the waste treatment process, while in the second option (that follows a “services are always inputs” logic) the waste treatment product flow would be an output flow of the waste treatment process.

It is also to be highlighted that for many services, but also for complex multifunctional goods (e.g. Personal Computers) the identification and quantification of the functional unit is not straightforward but it depends among others on a combination of specific use profiles.

Additional quality aspects are addressed in chapter 6.9.2.

### **Frequent errors: Comparisons not based on the relevant functional unit**

Comparisons shall not be performed on basis of any other reference than equivalent functional units. Comparisons between different materials on a mass basis (e.g. “1 kg glass” vs. “1 kg PET”) are thus meaningless and misleading. A comparison of materials can only be done in context of the products in which they are used. This is to consider their function by specifying and quantifying them in the functional unit (e.g. “1 l one-way glass bottle” vs. “1 l one-way PET bottle”, and: “... both for still water delivery to final consumer”)<sup>38</sup>. Regarding limited substitutability of products in niche markets see chapter 5.2.2.

A comparison on the level of materials can only be done in a meaningful way if this is done for the same material by comparing different technologies or production routes (e.g. “1 kg polyamide 6.6 from crude oil via classical chemical route” vs. “1 kg polyamide 6.6 from corn stalks via combined biotechnological / chemical route”). In this example the comparison is in fact between technologies/routes (with the same functional unit of “output of 1 kg polyamide 6.6”) and NOT between materials. Note that also for such comparisons the same quantitative and qualitative properties of the two polyamide 6.6 variants must be ensured, e.g. in terms of molar weight, colour etc. to allow for a valid and fair comparison.

## 6.4.3 Qualitative aspects of the functional unit

(Refers to aspects of ISO 14044:2006 chapter 4.2.3.2)

### **Difference between quantitative and qualitative aspects**

The qualitative definition of the system’s function(s) is a description of the way in which the function(s) are provided and of other qualities of the product. These qualitative aspects are to include those aspects that are not easily quantifiable. Examples are e.g. the resistance to humidity (e.g. of a shopping bag) or aspects that relate to the user’s perception of equivalence and substitutability if the compared product and that are therefore important to ensure a fair comparison. Perception aspects can be e.g. the perception of the product as being fashionable or of possessing specific design-features such as shape, touch, etc.

### **Using qualitative aspects for better informed comparisons**

The relevant qualitative aspects shall be documented, as they can be decisive for the user’s acceptance of the product. This is necessary to ensure that the compared products are indeed comparable – for the user. In the end the central stakeholders of the study (e.g. the customer, competitors, etc.) determine, which qualitative aspects need to be documented in support of a fair comparison. The definition of a functional unit must hence include both the quantitative and the key qualitative aspects to avoid subjectivity when subsequently defining equivalence. Especially for complex products, that may differ in a number of qualitative aspects (e.g. two cars of different levels of comfort), it is important that the equivalence of the “functional unit” is carefully ensured to ensure valid and defensible comparisons and even more so for comparative assertions disclosed to the public. It shall be highlighted in the

<sup>38</sup> In this specific case, the functional unit is to be complemented by other quantitative/qualitative information such as migration, taste preservation, gas permeability or shelf life that needs to be addressed at least qualitatively to ensure the comparability in view of the consumer.

interpretation in which qualitative aspects the alternatives differ and clarify that the acceptance of equivalence exclusively lies with the user, i.e. the alternatives are technically equivalent and can technically be compared.

The use of Quality Function Deployment (QFD) approaches can help to improve comparability of alternatives; for more see chapter 7.9.3.3.

### **Comparison of systems that are not fully comparable**

The above can be expanded on studies that compare alternatives where the equivalence and comparability is even predominantly a matter of customer perception. For these comparability cannot be measured objectively. This is the case e.g. for many services: for one customer two four-star hotels may not be comparable, while for others a four-star hotel might be comparable with a three-star hotel (or actually prefer a private pension), given the specific characteristics, location, etc. For one individual watching TV for one hour is equivalent to reading a book for one hour, for another not at all (see also chapter 6.4.6 under "Non-technical functions and functional units").

The results of such comparative studies shall hence be presented with the explicit statement that comparability is not assumed per se, but lies with the individual preference and judgement.

### **Separation of impacts within the technosphere that are related to product properties**

In the special case of products that have relevant impacts on humans directly within the technosphere (e.g. food, drink, tobacco products etc.) and not via emissions to the environment, such impacts should be generally identified and documented in the description of the product or can be inventoried in separate inventory lists and undergo a specific, separate impact assessment. These impacts shall not be combined with interventions with the ecosphere in the life cycle inventory (see chapter 7.1). Such complementary information is to be explicitly considered in the LCA results interpretation, to avoid misleading interpretation. Other tools, such as e.g. risk assessment, may be used to appropriately capture and assess these properties in a modular way together with those covered by the LCA, i.e. interventions with the ecosphere.

## **6.4.4 Working with obligatory and positioning properties**

(No corresponding ISO 14044:2006 chapter)

In product development the concepts of 'obligatory properties' and 'positioning properties' are sometimes used. Wherever available, these may be used in LCA when determining the functional unit of a product.

The obligatory properties are features that the product must possess for the user to perceive it as a functionally useful product (e.g. for exterior wall paint this would be among others the ability to cover and protect the wall against the weather). Also all legal requirements belong to the obligatory properties (e.g. limits / ban of toxic compounds in the paint).

The positioning properties, on the other hand, are optional features which can be used to position the product in the market as more attractive to the customer than other, similar products (e.g. for the above paint example: drip-free application, large selection of different colour tones, guarantee to be available for order for next 10 years, etc.). Examples include comfort, image, and aesthetic aspects of the product. A complete example with the "paint" as case see Table 4.

Regarding limited substitutability of products in niche markets see chapter 5.2.2.

The quantitative definition of the function of the product and some key qualitative aspects will typically be based on the obligatory properties of the product, while other qualitative aspects that typically relate to the user perception may be identified among the positioning properties.

**Table 4 Example for function, functional unit and reference flows in a comparative case: Outdoor wall paints comparison ( 2 alternatives)**

Obligatory properties → quantify in functional unit	Positioning properties → document
<ul style="list-style-type: none"> <li>• Cover wall with uniform colour</li> <li>• Protect wall against the destructive agents rain, sun, and microalgae</li> <li>• Provide surface which is easy to clean</li> <li>• Meet health requirements during application</li> <li>• ...</li> </ul>	<ul style="list-style-type: none"> <li>• Drip-free application</li> <li>• Many different colour tones to select from</li> <li>• Water-based system</li> <li>• Fast application (needs only one application as well covering or very viscous)</li> <li>• ...</li> </ul>
<p><b>Functional unit</b> Coat and cover 1 m<sup>2</sup> outdoor wall according to standard XYZ (under defined (e.g. per-humid tropical) weather conditions) with a red colour (colour code XYZ) for 10 years.</p> <p><b>Reference flow</b></p> <ul style="list-style-type: none"> <li>• Paint A: 6.5 l solvent-based paint A (needs two applications and a re-paint<sup>39</sup> after 5 years, i.e. twice 3.25 l)</li> <li>• Paint B: 3.8 l water-based paint B (drip-free, needs only one application and lasts 10 years)</li> </ul>	

## 6.4.5 Using technical standards for defining function and functional unit

(No corresponding ISO 14044:2006 chapter)

The quantitative definition of a product's functional unit should refer to technical standards wherever possible and appropriate (e.g. standards on the thermal conductivity for determining the insulation capacity of insulation materials for exterior house walls; or standards on opacity measurement for determining the opacity of a wall paint). Whether a standard is appropriate depends on whether it captures the functional unit in the way the LCA requires it, i.e. in a comparable, differentiated way, capturing the different process operation cycles in an averaging way and so on.

<sup>39</sup> Note that in this example the need for re-painting may result in the need for additional processes to be included in the system boundaries, e.g. for removing loose paint layers of the first application when applying the second one etc. Note also that for the repainting - as occurring in the future - a potentially further developed paint would be used, i.e. this is not equivalent to twice painting the same, "old" paint.

### **Frequent errors: Using inappropriate technical standards to quantify the functional unit**

Standardised measurement protocols are an indispensable means to improve the comparability of products. However, not all technical standards are directly or at all suitable for LCA. Such negative examples are e.g.

- the direct use of 5 minutes average peak-measurements of emissions instead of mass-flow averaged data,
- the use of base-load measurements excluding start/shut-down cycles instead of covering the entire cycle (see also chapter 7.4.2.7),
- the direct use of maximum electricity uptake information on energy-using devices instead of the actual consumption (e.g. "2 kW" for a cooling fan, which may however run usually only on e.g. 80 % of its capacity and only for parts of the time),
- the reported "driving cycle mix" fuel consumption of vehicles that may not necessarily reflect the average consumption in normal use but serve for general comparability / legal purposes only),
- the initial capacity of a starter battery that will be reduced with ageing; even more this ageing might differ between different battery concepts, or
- the initial light-intensity of a halogen light bulb that does not account for specifically reduced values after ageing during use stage, etc.

The key question is whether the measurement method is appropriate for a comparison of the life cycle performance of the analysed systems.

The technical understanding of the analysed technologies or service operations combined with LCA expertise is the indispensable pairing that is needed to appropriately quantify the functional unit of products for the comparative use in LCA.

Harmonised standards under ISO should be preferred for this purpose wherever available.

In the case of lack of applicable and appropriate technical standards, and only then, it is permissible and required as part of the LCI/LCA study to specify in an appropriate and reproducible way and clearly document how the functional unit has been measured.

If qualitative properties play a relevant role in the market for a product group, also they should be documented using technical standards, if available and appropriate.

## **6.4.6 Functional unit and/or reference flow?**

(Refers to aspects of ISO 14044:2006 chapter 4.2.3.2)

### **Application-unspecific products: Reference flow as 'declared unit' and product specification instead of functional unit**

It is important to note that not all systems have clear or unique functional units:

For application-unspecific materials such as steel, gypsum, etc. but also for multiple use machines such as trucks, waste incinerators, etc. the number of possible applications and hence functional units is often extremely large to virtually indefinite. In such cases where one or few, relevant functional units cannot be given, it is crucial to clearly and both quantitatively and qualitatively identify the reference flow as the detailed name of the product plus further information that identifies its relevant characteristics and the location-type. This supports a correct subsequent selection and use of the data in other systems.

For example would a cradle-to-gate steel data set obtain the detailed reference flow of 1 kg of "Stainless Steel Hot Rolled Coil, Annealed and Pickled; Electric Arc Furnace route;

production mix, at plant; grade 304 (Austenitic, 18 % chromium, 10 % nickel)". This is also called 'declared unit', as a general functional unit cannot be given and a simpler mass, volume, area, pieces, or similar unit is used instead. Additional information about technical applicability of this steel further guides the correct use of the data set. In the subsequent uses of the data set in another (product) system, the exactly required amount would be specified (e.g. 0.753 kg of the "Stainless Steel Hot Rolled ..."), ensuring proper identification of the process and its quantification via the reference flow.

In the example of a truck, a specific transport scenario would be defined in the study that uses the data set for the specific truck used, ensuring again a clear identification and quantification. E.g. the transport scenario "150 km overland transport of bulk sand transport at 90 % load factor" with the quantity and unit of e.g. 1 t\*km and the data set "Truck bulk transport; Euro 0, 1, 2, 3, 4 transport mix; 22 t total weight, 17.3 t max payload".

### **Multifunctional processes: Functional units and reference flows**

If a process has more than one product as output (co-production e.g. of different chemicals in a synthesis process with valuable by-products), or is treating more than one waste on the input side (co-services), it is called a multifunctional process (see also Figure 6). In consequence, it has more than one reference flow and all of them shall be well defined and specified.

Whether all of the reference flows also have one (or even more) corresponding functional units depends on the kind of functions or products (see the provisions above and below in this subchapter).

### **Multifunctional products with additive/parallel functions: one reference flow (or one per function, depending on model needs), detailed technical specifications, additive/parallel functional units as for the given case appropriate**

Methodologically equivalent to multifunctional processes but typically in need of a different way of specification are multifunctional products: a product can have several functional units with functions that may be used subsequently or even in parallel (e.g. a mobile phone that can be used for phoning, storing and playing music, receiving SMS, as alarm clock, etc.).

The actually used functions and the extent of use depends however on the individual user. However, a set of functional units that represent a typical or average use profile and that accounts for the technical lifetime can and should be provided as a minimum. Additionally or alternatively the technical product specification serves the purpose to inform the data set user and should be documented. In product comparisons, the typical or average use case or specific use scenarios would then be defined and compared, combining the various aspects of the quantitative product specification.

The reference flow of such LCI data sets would identify the type of product and its brand name, model, etc. while the technical specification would overload the reference flow name and may hence be provided in the data set documentation.

### **Systems with alternative functions: one reference flow, detailed technical specifications, alternative functional units as for the given case appropriate**

Next to multifunctional products or processes that provide more than one function (e.g. mobile phones) or produce more than one product (e.g. co-production of wheat grain and straw), some systems can have several, alternative functional units depending on the context in which they are used in (e.g. a specific paint for both indoor and outdoor use with different life-time/resistance).

These products are not multifunctional in the sense of an LCA, as they can only perform one of the alternative functions. In such cases and if comparisons are among the intended applications, the main or application-unspecific functional unit should be documented as default. It is recommended to additionally document and define the main other functional units to ease subsequent comparisons and the technical product specifications should be provided.

### **Highly variable functions of processes and products: parameterised data sets**

The use of parameterised data sets or even system models can provide quantitatively usable information on functions that are highly variable. This is the case when different e.g. use patterns result in strongly changed LCI data, such as for many flexible machines and processes, such as waste processing (with varying waste composition), transport (with different load factors and road types used). Such supports a much better and accurate subsequent use.

Regarding the functional unit, reference flows, etc., see the other recommendations in this subchapter.

### **Non-technical functions and functional units**

Next to the specific, often technical functions that goods and services have, they have often other, non-technical functions that can be of interest in life-style type studies. As an example, the function of personal entertainment is illustrated:

A number of products and personal services (e.g. watching TV, receiving a massage, riding a bicycle, etc.) that we use in our leisure time, have the special property of also relating to the duration of our personal time that we spend with them. Hence, products with technically entirely different functions may usefully be compared from the perspective of how much of our personal time they fill with 'entertainment'. This can be used e.g. in life-style analysis or to position and improve leisure-oriented goods and services environmentally. "The duration of filling one's (leisure) time with entertainment" is hence a special and additional property that can be used as functional unit. Restrictions as to the interpretation of the results and the equivalence of the compared activities are to be carefully observed when doing so. However, it is argued that in this specific case the risk of being misleading is low: other than when comparing other types of products that differ in the qualitative aspects of their functional units, in this case it is obvious that they differ regarding the technical function they perform. It is argued to be fully within the judgement of the consumer to decide whether he or she considers one hour watching some entertainment program on TV is equivalent (in the view of the consumer!) as is one hour reading a book or one hour playing chess. The related issue of positioning principles has already been addressed.

It is acknowledged also that further work on a more comprehensive guidance would be beneficial in this field of non-technical functions and related studies.

## **6.4.7 Comparisons of systems and the functional unit**

(Refers to aspect of ISO 14044:2006 chapter 4.2.3.2)

Special provisions on the functional unit apply to comparisons and especially comparative assertions disclosed to the public; details see chapter 6.10.3.

In the case of only partial equivalence, mechanisms exist to render them comparable in many cases. The details depend on the applicable LCI modelling principle and approaches that are still to be identified; details on rendering systems comparable are addressed in chapter 7.9.3 for attributional modelling and chapter 7.2.4.6 for consequential modelling; the simplified provisions for Situation A, B and C are found in chapter 6.5.4.

## Provisions: 6.4 Function, functional unit, and reference flow

Note that for further processes that were identified as part of the life cycle model beyond the central process(es) that can be identified in the initial scope phase, these provisions will be applied only in the later iterations and in the LCI phase.

- I) **SHALL - Identify system or process:** Identify in line with the goal and with the other scope settings the to-be-analysed system(s) or process(es)<sup>40</sup> (e.g. good, service, technology, strategy, country, etc.) and describe it/them in an unambiguous way (6.4.1).
- II) **MAY - Photos, specifications:** Provide photos, and/or technical specifications, and/or descriptions of the system(s), if and as appropriate for the addressees (6.4.1). [ISO+]
- III) **SHALL - Identify function(s) and functional unit(s):** One or more function(s) and quantitative, measurable functional unit(s) of each of the system(s) shall be clearly identified, if applicable and appropriate for the type of system (for exceptions see the following provisions on subchapter 6.4.6) (6.4.2).
- IV) **SHALL - Functional unit, details:** The functional unit(s) shall be identified and specified in detail across all the following aspects (6.4.2, 6.4.3):
  - IV.a) Function provided (what),
  - IV.b) in which quantity (how much),
 

Note that, even though the "how long" information is important, the use intensity and resulting overall quantity of the performed function is key to valid comparisons.
  - IV.c) for what duration (how long), and
  - IV.d) to what quality (in what way and how well is the function provided).
  - IV.e) Changes in the functional performance over time (e.g. due to ageing of the product) shall be explicitly considered and quantified, as far as possible. [ISO+]
- V) **MAY - Obligatory and positioning properties:** If product systems are analysed, it is recommended to use obligatory and positioning properties for the quantitative and qualitative aspects of their function, respectively (6.4.4). [ISO+]
- VI) **SHALL - Measurement methods:** ISO or national harmonised standards shall be used as measurement methods, as far as possible and wherever available and appropriate for use in an LCA context. Own measurement methods should only be used in case of unavailable or inappropriate harmonised standards only. They shall be clearly specified and documented and later be subject to critical review (6.4.5).
- VII) **SHOULD - Alternatives and complements to the functional unit:** It is noted that a functional unit cannot always be given or is not appropriate / useful. In such cases, it should be replaced or complemented by another clearly defined, quantitative and measurable item as outlined below; deviations shall be concisely justified (6.4.6): [ISO!]
  - VII.a) **Materials and other application unspecific products:** A functional unit cannot generally be given. Only the reference flow that includes the main technical specification of the product should be provided. In this case, the reference flow is

<sup>40</sup> Plural in case of comparisons.



### Provisions: 6.4 Function, functional unit, and reference flow

also the declared unit, but not the functional unit.

- VII.b) **Multifunctional processes:** For each function one functional unit and/or reference flow should be given, as appropriate, depending on the kind of co-function / co-product (see other items in this sub-list). Otherwise the technical specification of the process and functions should be provided in the accompanying documentation.
- VII.c) **Monofunctional systems:** For systems (e.g. products) with only one relevant function or combination of functions, the functional unit(s) should be specified. In addition, one reference flow with a clear and detailed system name should be provided. The functionally relevant technical specification should be provided as part of the reference flow name and/or in the accompanying documentation.
- VII.d) **Multifunctional systems:** For multifunctional systems with multiple, parallel functions, the detailed technical specification should be provided. The corresponding functional units should be given in addition and when appropriate to the given case. One reference flow with a clear and detailed system name should be provided. (This one reference flow can be split up into each one reference flow for each function in case the data set is directly used in comparative studies. This to allow substitution of single functions to achieve equivalence of compared alternatives.)
- VII.e) **Systems with alternative functions:** For systems with alternative functions, the most relevant alternative functions and functional units should be specified. In addition, one reference flow with a clear and detailed system name shall be provided. The functionally relevant technical specification should be provided as part of the reference flow name and/or in the accompanying documentation.
- VIII) **SHOULD - Highly variable functions:** For highly variable functions of processes and systems, the way that the variable and parameters relate to the system's performance and to its inventory should be documented. This should be in form of mathematical relations or in another suitable form. The use of parameterised data sets is recommended to support appropriate documentation and efficient use.
- IX) **SHALL - Comparative studies:** For comparative studies, see the additional special provisions in chapter 6.10.3 (6.4.7). Among others, they shall be compared based on their reference flow.

Detailed recommendations on the use of flow properties and units for product and waste flows are given in the separate document 'Nomenclature and other conventions'.

## 6.5 Life Cycle Inventory (LCI) modelling framework

(No directly corresponding ISO 14044:2006 chapter<sup>41</sup>; subchapters relate to aspects of several ISO 14044:2006 chapters)

### 6.5.1 Introduction and overview

(No corresponding ISO 14044:2006 chapter)

#### Introduction

Early in the scope definition an important decision must be made on the life cycle inventory modelling principles and method approaches that are to be applied in the modelling of the system: attributional or consequential modelling and allocation or system expansion / substitution approaches. This has implications for many of the later choices including on which inventory data are to be collected or obtained.

This decision is to be made in accordance with the goal of the LCI/LCA study. Especially does it depend on the decision-context of the LCI/LCA study as well as a number of other criteria such as reproducibility and robustness, practical feasibility, stakeholder acceptance, and others. The choice of the LCI modelling framework and approaches is hence not an independent one but is to be derived individually for each study along the study's goal.

Frequent errors: Subjective or unsystematic choice of LCI modelling principles and method approaches

It is a frequent and severe error in LCA practice to “always perform attributional (or consequential) LCA” and to “always allocate” (or “do substitution”). Equally is it incorrect to unsystematically combine attributional and consequential modelling in the same system model on an ad hoc basis, e.g. allocating among the co-products of one multifunctional process and substituting the co-products of another. Instead a systematic approach needs to be followed; chapter 6.5.4 gives guidance on this.

#### Overview

After an introduction to the two main LCI modelling principles (attributional and consequential) and the related main LCI method approaches (allocation and system expansion / substitution), the LCI methodological provisions are detailed for the three earlier identified archetypal goal situations A, B, C into which the LCI/LCA study belongs.

Guidance on how to in practice identify processes for attributional or for consequentially modelling is given in chapters 7.2.3 and 7.2.4. How to solve the specific multifunctionality of recycling / end-of-life treatment is explained in detail in the annexes 14.4 (attributional modelling) and 14.5 (consequential modelling). The simplified provisions for Situation A, B, and C are found in chapter 6.5.4.

### 6.5.2 The two main LCI modelling principles

(No corresponding ISO 14044:2006 chapter)

Two main LCI modelling principles are in use in LCA practice: attributional and consequential modelling, with the former being more widely used for historical and practical

---

<sup>41</sup> While the issue of allocation/multifunctionality is well covered in ISO 14044, the initial and more fundamental issue of determining the appropriate LCI modelling framework is not addressed in any detail in ISO 14044 and hence has no corresponding chapter there.

reasons. They represent from their logic the two fundamentally different situations of modelling the analysed system (e.g. a product):

- The attributional life cycle model depicts its actual or forecasted specific or average supply-chain plus its use and end-of-life value chain. The existing or forecasted system is embedded into a static technosphere.
- The consequential life cycle model depicts the generic<sup>42</sup> supply-chain as it is theoretically expected in consequence of the analysed decision. The system interacts with the markets and those changes are depicted that an additional demand for the analysed system is expected to have in a dynamic technosphere<sup>43</sup> that is reacting to this additional demand.

The following boxes explain and illustrate these two principles in a bit more detail:

### Terms and concepts: Attributional modelling

The attributional life cycle inventory modelling principle is also referred to as "accounting", "book-keeping", "retrospective", or "descriptive" (or sometimes and potentially confusing: "average" or "non-marginal"). It depicts the potential environmental impacts that can be attributed to a system (e.g. a product) over its life cycle, i.e. upstream along the supply-chain and downstream following the system's use and end-of-life value chain. Attributional modelling makes use of historical, fact-based, measureable data of known (or at least knowable) uncertainty, and includes all the processes that are identified to relevantly contribute to the system being studied.

In attributional modelling the system is hence modelled as it is or was (or is forecasted to be). This also applies to its background processes: As background data, producer-specific LCI data is ideally used where specific producers provide a background good or service (e.g. a single tier-two supplier is producing the required bricks for a large office building). Average or generic data is typically used where the goods and services stem from a wide mix of producers or technologies (e.g. for electricity consumed by a consumer product in Austria the Austrian consumption mix of electricity with the actual quantitative share of power plants using hydro-power, natural gas, hard coal, fuel-oil, nuclear power, biomass, etc. would be used, including the specific electricity imports and exports to/from the Austrian market). The change from specific to average or generic data is only done for practicality reasons and is a simplification that is justified from the averaging effect that typically occurs several steps up and down the supply-chain and value chain.

More details on how to model a system with the attributional modelling principle are given in chapters 7.2 and 7.8.

### Terms and concepts: Consequential modelling

The consequential life cycle inventory modelling principle is also called "change-oriented", "effect-oriented", "decision-based", "market-based" and (older and incompletely / misleadingly capturing the issue: "marginal" or "prospective"). It aims at identifying the consequences that a decision in the foreground system has for other processes and systems

<sup>42</sup> These "generic" and "specific / average" supply-chains are not to be confused with generic and specific / average LCI data.

<sup>43</sup> Additionally also the interactions with the political system and society may be included by modelling possible public and private policy and behaviour consequences.

of the economy, both in the analysed system's background system and on other systems. It models the analysed system around these consequences. The consequential life cycle model is hence not reflecting the actual (or forecasted) specific or average supply-chain, but a hypothetic generic supply-chain is modelled that is prognosticised along market-mechanisms, and potentially including political interactions and consumer behaviour changes.

To better reflect market constraints and supplier-related explicit decisions, some researchers constrain the market-mechanism models by explicitly considering existing supply-contracts and planned future suppliers. Other constraints in use are existing or expected policy measures such as e.g. green taxes / incentives and material bans.

A key step in consequential modelling is the identification of the marginal processes, i.e. the generic supply-chain, starting from the decision and building the process chain life cycle model around it (details see chapter 7.2.4). Some experts identify each one single marginal process, others identify a combination of several of the most likely marginal processes to have a more robust estimate.

A wide range of mechanisms is discussed among LCA practitioners, how a decision affects other processes and products, and which type of consequences follow: These mechanisms range from causing the need to build new production plants for additionally required materials, parts, etc. (or taking plants out of operation), to market displacement of competing products, consumer behaviour changes, and the like. Secondary consequences may counteract the primary consequences (then called 'rebound effects') or further enhance the preceding consequence.

Regarding modelling the main market consequences, components of general (and in some cases partial) equilibrium models are employed. Central in modelling market consequences is a quantitative understanding of the markets and how direct and indirect changes in supply and demand of the analysed good or service act in the markets to cause specific changes in demand and supply of other goods and services.

More details on how to model a system with the consequential method principle are given in chapter 7.2.4 and 7.8.

Closely related to the choice of the appropriate LCI modelling framework is the choice of how to solve multifunctionality of processes and products (grouped under the common heading "allocation" in ISO 14044:2006). This issue is therefore explained and illustrated before detailing the provisions on the LCI modelling framework and how to deal with multifunctionality for the three distinct archetypal goal situations A, B, and C:

## 6.5.3 LCI method approaches for solving multifunctionality

(Refers to ISO 14040 chapter 4.2.3.1)

### 6.5.3.1 Introduction

#### **Multifunctional processes**

If a process provides more than one function, i.e. delivering several goods and/or services (often also named simplified "co-products"), it is "multifunctional" (see Figure 6).

A classical example is the electrolysis of sodium chloride solution, providing the co-produced goods sodium hydroxide solution, chlorine gas, and hydrogen gas. The co-treatment of different wastes in a waste incinerator is another example; in that case the process provides several co-services of treating distinct wastes.

In most LCI/LCA studies of simple goods and services, one is interested in the specific life cycle inventory of only one<sup>44</sup> of the co-functions (e.g. only of the sodium hydroxide solution OR the chlorine gas, of the above example). To achieve this, only the appropriate inputs and outputs of the process (i.e. consumed materials, energy carriers and parts, resource flows, emissions, wastes, etc.) are to be counted for the analysed function. I.e. the inventory of the specific function is to be isolated.

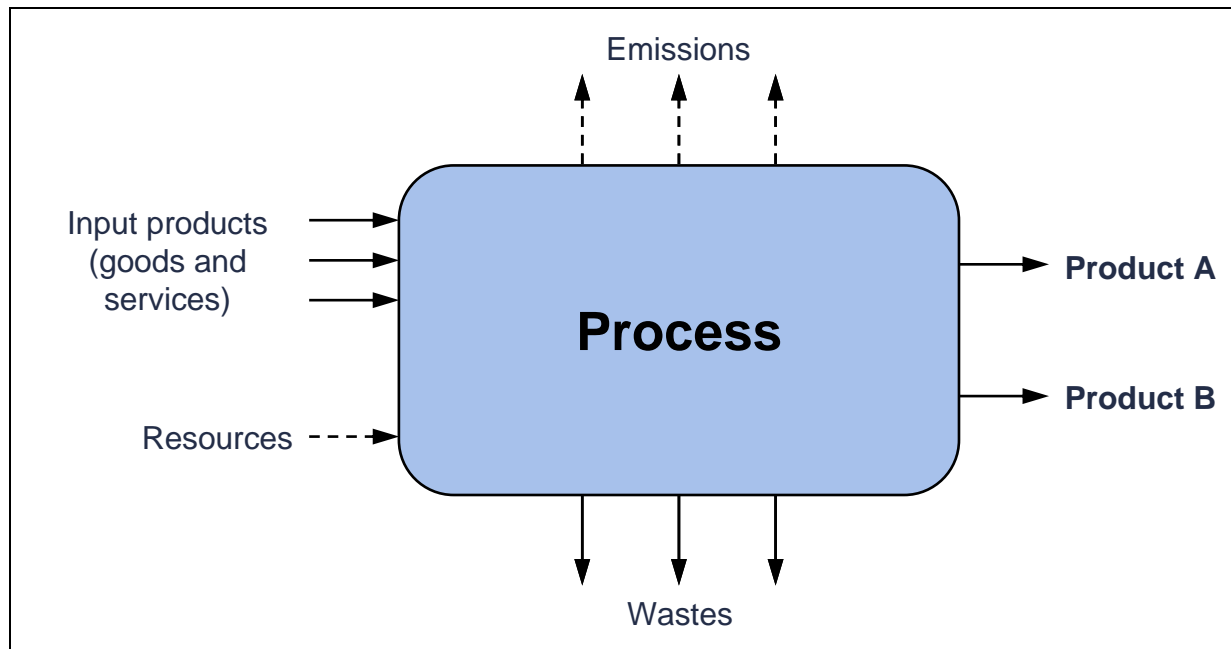

**Figure 6 Multifunctional process with several input products and resources consumed and various wastes and emissions generated as well as providing the two co-products 1 and 2.**

### Multifunctional processes with multiple sets of co-functions

In rare cases, a multi-functional process may have more than one set of co-functions. An example is the incineration of different wastes that result in the production of electricity and steam as co-products. It depends on the perspective of the study, i.e. the question posed, which of the here two sets of co-functions is the set that will effectively be considered to be the relevant co-functions of the process: In the case the study aims at calculating an inventory for one of the wastes, the services of the treatment of the different wastes are the co-functions. If the study in contrast aims at calculating the inventory for the electricity or the steam, these two are the relevant co-functions. For the latter example and in case of allocation, the inventory would be allocated between these two only and all other flows including the waste treatment services would be considered non-functional product flows only. In the case of substitution only the not required co-function (i.e. steam or electricity, depending on which of the two is the required co-function) would be substituted.

### Multifunctional products

A variant of multifunctional processes is the multifunctional product (e.g. a mobile phone), which is methodologically equal, but is modelled typically differently in LCI data sets: while each co-function of the before-mentioned multifunctional processes has a separate reference flow, in this case typically only one reference flow is used. This is justified not only as the

<sup>44</sup> This holds true also when the whole technology (e.g. a waste incineration plant) is to be analysed and improved with help of the LCA results: it is necessary to get comparative values for the co-products/-functions and therefore one needs to single out the inventories of all the individual co-products.

user perceives e.g. the named mobile phone as one product, but also as it is further managed (e.g. packaged), transported, used and discarded as one item, i.e. different from the other cases that have physically distinct goods (or services).

For LCI/LCA studies on complex goods and services (e.g. the mobile phone), that often combine several functions in one physical unit of a product, in contrast, the product as a whole with all its functions is of interest. However, when it comes to comparisons with similar products, the need comes up to make the alternatives fully comparable, e.g. the to-be-compared mobile phone model may lack at least one the functions (e.g. MMS) or differs in quantitative aspects of at least one of the functions (e.g. storage space for pictures and music clips).

### **Solving multifunctionality**

Different approaches are used for solving multifunctionality. The choice of the most appropriate approach depends among others on the goal situation of the study, available data and information, and the characteristics of the multifunctional process or product.

The most appropriate way how to solve this multifunctionality is to be identified already in the scope phase of the LCA (or at least in the inventory phase when planning data collection), as it affects which inventory data and other information is required. This topic and the related concepts are hence introduced in the remainder of this chapter; they serve also as basis for the later application of the approaches as part of the inventory work.

## **6.5.3.2 The ISO hierarchy for solving multifunctionality**

### **Introduction**

Under the heading "Allocation", ISO 14044:2006 presents a hierarchy of different approaches to this multifunctionality problem<sup>45</sup>. This hierarchy is the starting point for developing the ILCD guidance to this problem that is provided in detail for full attributional modelling in chapter 7.9 and for full consequential modelling in chapter 7.2.4.6. The systematic and somewhat simplified provisions for the main three goal situations A, B, and C that are encountered in LCA practice are given in chapter 6.5.4.

### **First approach: Subdivision of multifunctional processes**

The ISO hierarchy starts with the subdivision of multifunctional black box unit processes to mono-functional single operation unit processes<sup>46</sup> and thereby cutting free the actually required processes, avoiding the need for allocation (see Figure 7 and Figure 8).

---

<sup>45</sup> As the hierarchy covers other approaches than only allocation and also identified the first two approaches as "avoiding allocation", it is argued that clearer and more appropriate would be the encompassing title „Solving multifunctionality of processes“.

<sup>46</sup> The two sub-terms of "unit process" are introduced here to be able to differentiate between a) "single operation unit processes" that can physically not be further subdivided and b) "black box unit processes" that can be further subdivided. Allocation of black-box unit processes can result in distortions of the results if they include multifunctional processes.

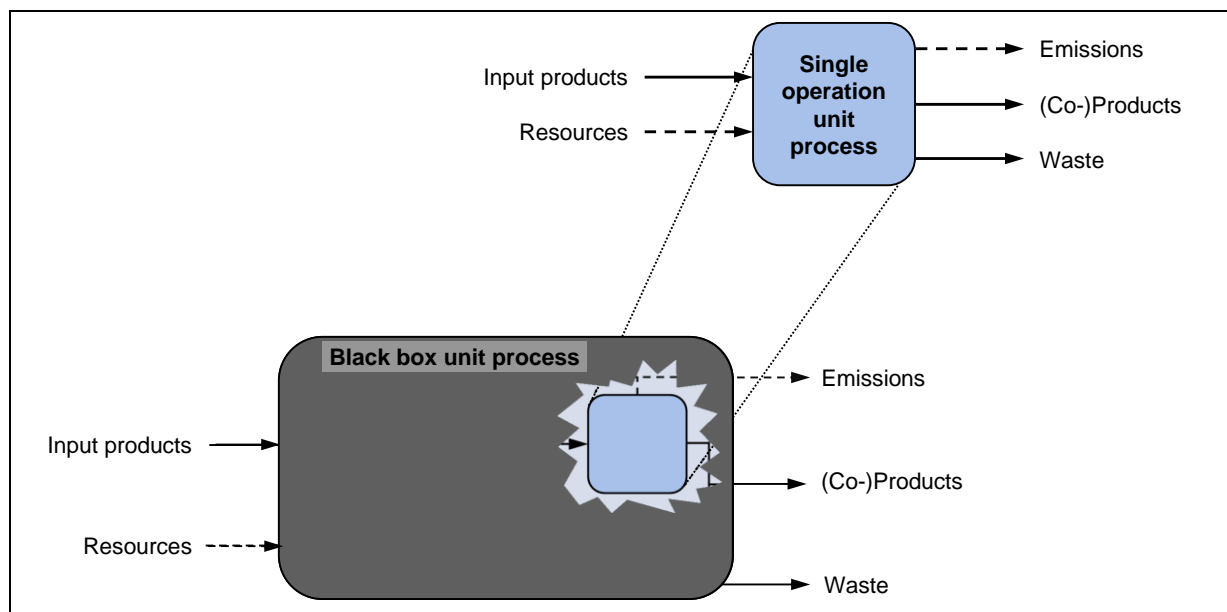

**Figure 7** Black box unit process and single operation unit process. Both can have one or more (co-)functions (e.g. co-products as shown here).

#### Terms and concepts: Subdivision of multifunctional processes

“Subdivision” of multifunctional processes refers to the collection of data individually for those of the mono-functional processes that relate to the analysed system and that are contained in the multifunctional process. Subdivision is often but not always possible to avoid allocation for black box unit processes; see Figure 7.

Thereby the actually required processes are cut free and the multifunctionality problem is solved. This is unless any of the included single-operation unit processes is still multifunctional. However, even then the data accuracy has been improved, often substantially. Note that subdivision is the only correct / exact solution under attributional modelling to solve multifunctionality of further sub-dividable processes; the 'short-cut' of allocation of black box unit processes will often result in distorted inventories, as explained in the text.

Under consequential modelling subdivision is also applicable<sup>47</sup>.

See also chapter 7.4.2.2 with more details on subdivision, partial subdivision, and virtual subdivision.

<sup>47</sup> However, it could be argued that the logic of consequential modelling might request to account for synergies and other interrelations of processes that operate e.g. on the same site. This foreground-system internal interrelations and consequences needs still further methodological clarifications. Similarly, the synergies on site-level might even need to be considered in attributional modelling by an allocation of synergies. E.g. on a site a small steam consuming process may benefit from a big steam consuming process that has lead to the installation of a very efficient steam generating process.

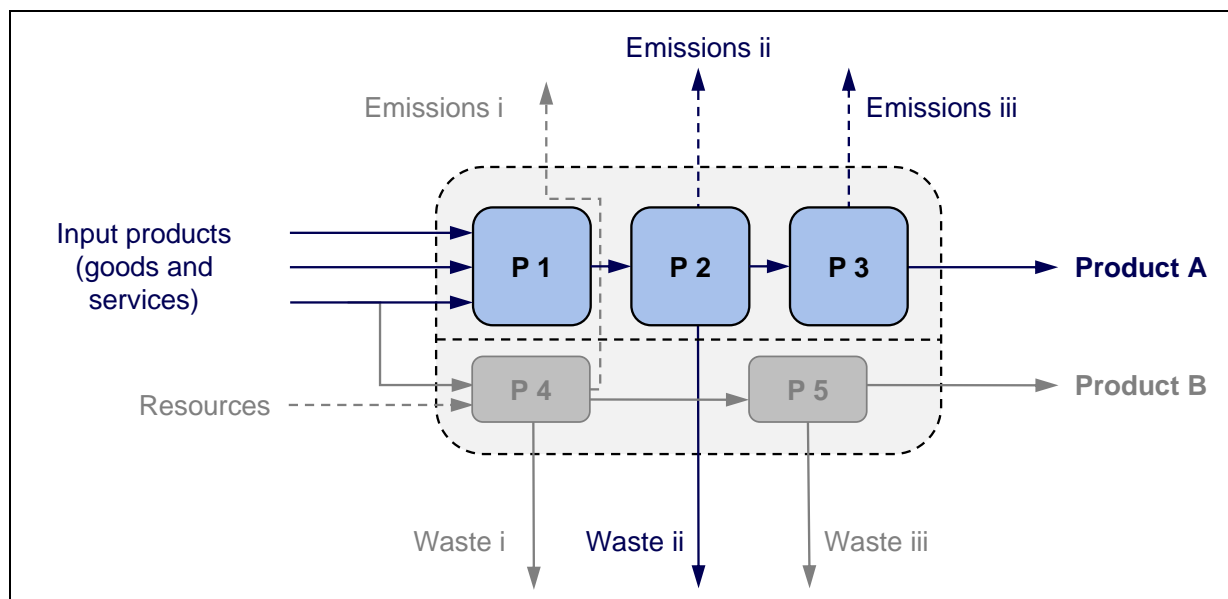

**Figure 8 Solving the multifunctionality problem (see Figure 6) by subdivision of the black box unit process. Subdivision yields exclusively the process-chain of mono-functional unit processes “P1” to “P3” that result in the analysed “Product 1”.**

Subdivision can serve this purpose only, if the separated unit processes are not also multifunctional (as the example in Figure 8). However, next to potentially solving the multifunctionality, singling out the 'true' unit processes has other advantages for quality control and review, as the inventories do not combine several processes or even a whole site in a 'black box'. It is also noted that in case allocation is done on black box unit processes, the results are regularly distorted / incorrect, as normally not all processes inside a black box unit process relate to all co-functions to the same extent (see e.g. Figure 7).

In addition to what ISO says on the general case, it is noted that also under consequential modelling, substitution of co-functions of in principle subdividable unit processes will distort the results, hence, subdivision or virtual subdivision should be preferred.

Black box unit processes should be subdivided also if this does not solve the multifunctionality problem, as it renders it smaller and often easier solvable and as it improves reviewability<sup>48</sup>. Otherwise, the potentially distorting effect shall be explicitly considered when stating accuracy of results and drawing conclusions and recommendations. Note that, while subdivision requires collecting more specific data, it often avoids the need for otherwise required data: in the illustrative Figure 8, this is data for the treatment of the wastes A and C and in case allocation would be chosen, this is the allocation criteria information (e.g. physical properties, market prices etc.).

### **Second approach: System expansion (including substitution)**

As second option for avoiding the need for allocation the ISO hierarchy names the approach of system expansion. This can mean to add another, not provided function to make to system comparable (i.e. system expansion in the stricter sense) or to subtract not required function(s) substituting them by the ones that are superseded / replaced (i.e. substitution by system expansion).

<sup>48</sup> It is recognised that budget or time restrictions may often limit this possibility.



### Terms and concepts: System expansion / substitution

“System expansion” and its variant “substitution” are also called “system enlargement” and “crediting” / “avoided burden approach”, respectively. This is a combined concept for ensuring the equality of multifunctional systems with each other.

In practice two different situations can be encountered:

The first one is to solve the multifunctionality by expanding the system boundaries and substituting the not required function with an alternative way of providing it, i.e. the process that the not required function supersedes (“substitution”).

An example: Blast furnace slag is a joint co-product of steelmaking (typically in the range of 0.2 to 0.35 kg per kg hot metal). It is mainly used in cement making (superseding Portland cement) and in road building (superseding primary aggregates), while a smaller part is not used, i.e. deposited. If we want to obtain exclusively the life cycle inventory of producing blast furnace steel, the inventory of the co-function blast furnace slag will be eliminated from the process by subtracting the inventory of the superseded processes / systems<sup>49</sup>. In this way, we can obtain an LCI data set exclusively for the production of the steel from this process/plant. Here we have expanded the system's perspective by subtracting the not wanted function(s) via the life cycle inventory of alternative means to provide it. See Figure 9 for a schematic representation.

The other situation is when several multifunctional systems (e.g. different brands of a complex consumer product) are to be made comparable in a comparison study. This would be done by expanding the system boundaries and adding for the given case missing functions and the inventories of the respective mono-functional products: E.g. when comparing a combined copier, printer, scanner, fax machine with a combined copier, scanner, fax machine, the missing function “printer” would be added to the inventory of the second product system; see upper part of Figure 10 for the schematic representation.

The term system expansion is more illustrative in the second situation where we add one or more missing function(s).<sup>50</sup>

Note that both uses are mathematically equivalent as Figure 10 demonstrates (while not necessarily in their meaning and interpretation).

System expansion and substitution are the corresponding method approaches under consequential modelling for solving multifunctionality.

Substitution is also applicable for attributional modelling that is interested to include existing interactions with other systems (e.g. credits to existing / past recycling operations for avoided primary production), i.e. under Situation C1.

Substitution means to subtract the inventory of another system from the analysed system. This often leads to negative inventory flows. It can even result in negative overall

---

<sup>49</sup> Note that in full consequential modelling, any additional BOF slag would go to landfill, as the supply is already higher than the demand. In that case, nothing is superseded and landfilling would be modelled. Looking in contrast at the existing average situation, a high share of the already produced BOF slag is replacing e.g. Portland cement and avoids its production. In that perspective, it is appropriate to substitute the mix of alternative uses (and have only a share modelled as landfilled). As a second comment it is interesting to note that the modelling of “additional BOF slag” changes if the BOF slag would be already fully used e.g. in the named cement applications. In that case, also any additionally co-produced BOF slag would supersede Portland cement, since the market demand would be higher than the supply.

<sup>50</sup> The case of substitution could actually also be called “system reduction”.

environmental impacts for the analysed system. This means that there is a net benefit of producing the analysed system as the overall impact is more than compensated by the avoided impact the co-functions have elsewhere. This is the correct interpretation, if made within the assumptions of the study, including on the amount of co-functions produced.

This has nevertheless often lead to communication problems, especially to non-experts, as negative emissions and negative impacts are not directly intuitive. If such occurs, this needs special attention, including already in the reporting of results.

At the same time, such results can also be misleading, if wrongly interpreted that an unlimited production of the analysed system will lead to unlimited benefits. This however ignores that an ever-increased amount of production will produce very large amounts of the co-function, while the market for the superseded processes that was originally modelled might be much smaller. I.e. if the amount of the production is increased, the modelling would need to be changed to reflect whether the market can still take up the bigger amounts and these would still actually supersede any other process or system. This means that a study under Situation A can only be used to provide decision support under the original assumption that the not required co-functions are absorbed by the market and supersede the identified alternative processes / system and without large-scale consequences. Otherwise, for larger amounts, another mix of process / system might be superseded or the system would even need to be modelled under Situation B. Also a study under Situation B, e.g. on "10 % biofuels in China", cannot be used to support a decision on e.g. "50 % biofuels in China", as other large-scale consequences would likely occur in the rest of the society and industry that were not considered in the initial study but that would change the results.

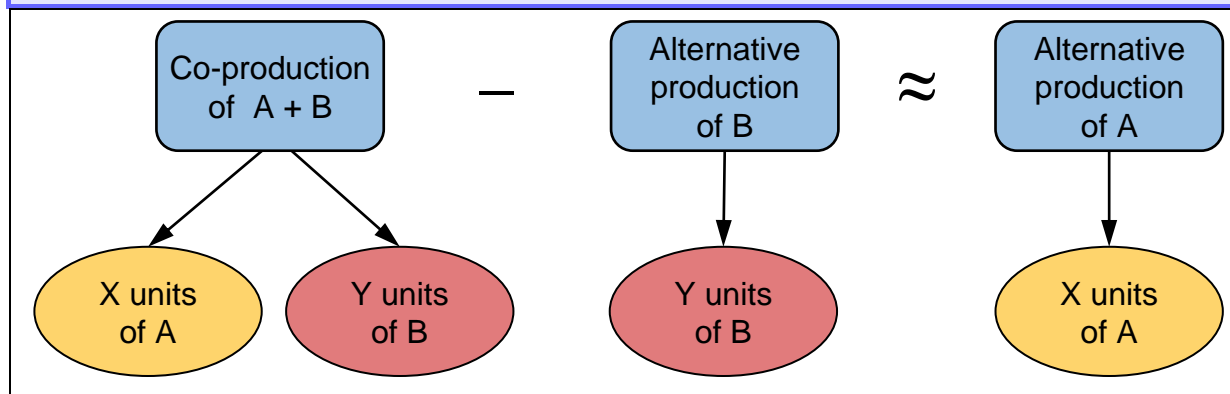
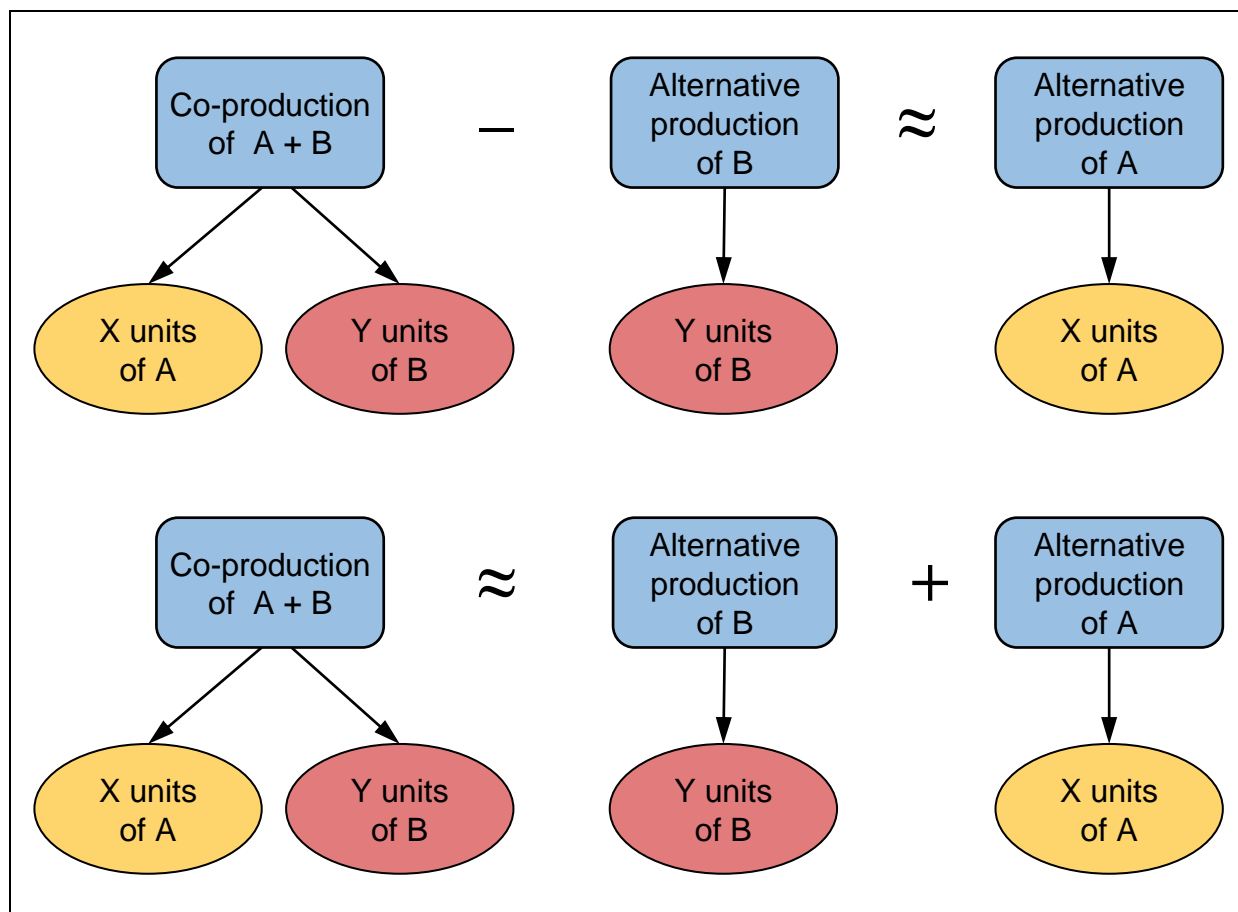

**Figure 9 Solving the multifunctionality problem by substitution of the not required co-functions, schematic.**

In practice, system expansion can lead to the need of further system expansion as the additionally included systems often are again multifunctional. This can be addressed in many cases via cut-off rules. There are however systems for which no alternative production / process for exactly the same function exists (e.g. rice grains and straw always grow together, i.e. there is no alternative production of rice grains to be substituted). A substitution of the function that the rice grains provides is however feasible, i.e. other grains and staple fruits can be assumed to be superseded. Depending on the specific situation this can however need to a large number of superseded systems, so that in the balance of effort and accuracy, pragmatic but systematic approaches are required.

In other cases, the alternative processes exist only in theory or are of no quantitative relevance in practice (e.g. Sodium hydroxide is basically exclusively produced from sodium chloride electrolysis, hence there is no truly superseded process of industrial relevance). Another challenge is that it is not straightforward to identify the one or more superseded

processes that should be integrated into the expanded system; the necessarily complex approach is detailed in chapter 7.2.4.



**Figure 10** Equivalence of additive and subtractive ("substitution") system expansion: Achieving functional equivalence of compared systems by either adding functions (system expansion, top) or subtracting them (bottom)

### Third approach: Allocation

As last step in the ISO hierarchy, allocation is named, partitioning the inputs and outputs between the co-functions according to some allocation criterion. ISO gives a preferred order of potential criteria; see box.

#### Terms and concepts: Allocation

"Allocation", also called "partitioning", solves the multifunctionality by splitting up the amounts of the individual inputs and outputs between the co-functions according to some allocation criterion, being a property of the co-functions (e.g. element content, energy content, mass, market price etc.); see Figure 11.

If possible, according to ISO 14044:2006, allocation should be performed in accordance with the underlying causal physical - and implicitly also covered: chemical and biological - relationship between the different products or functions. This should reflect the way in which the individual inputs and outputs are quantitatively changed by quantitative changes in the multiple functions delivered by the process or system. When it is not possible to find clear common physical causal relationships between the co-functions, ISO 14044:2006 recommends performing the allocation according to another relationship between them. This may be an economic relationship or a relationship between some other (e.g. non-causal

physical) properties of the co-functions such as energy content that is often used in the allocation between different fuels co-produced in a refinery<sup>51</sup>.

Note that if subdivision cannot provide exclusively mono-functional unit processes that can be attributed to the analysed function, allocation is the corresponding method approach under attributional modelling for solving multifunctionality of processes.

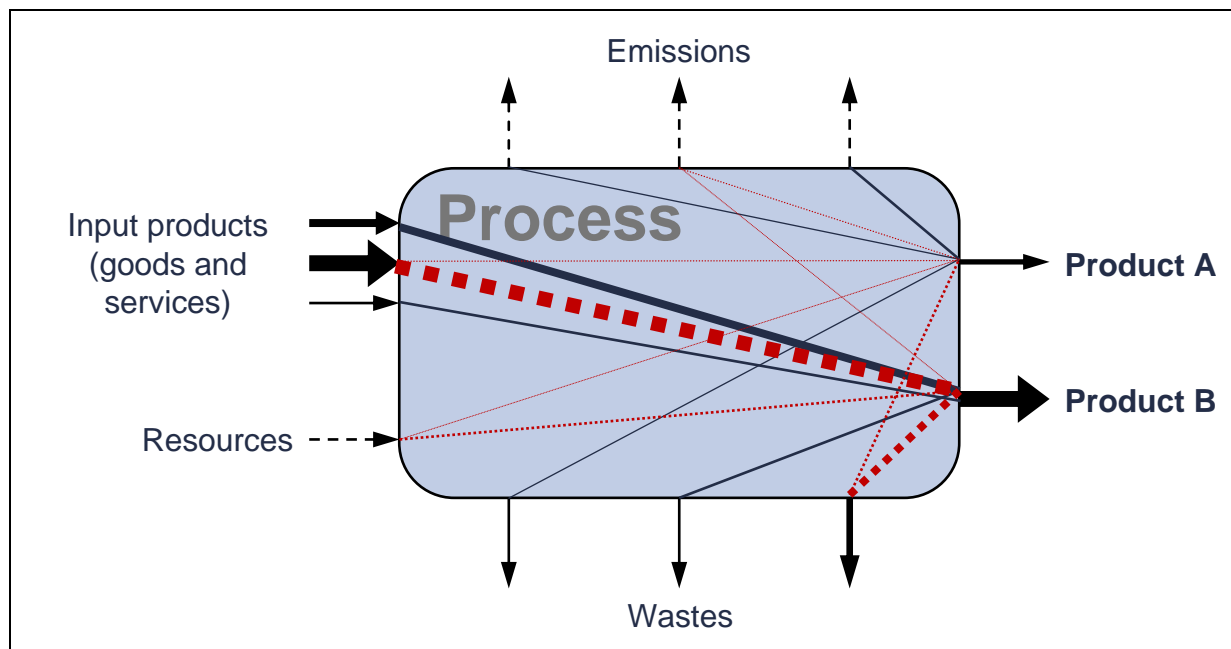

**Figure 11 Solving the multifunctionality problem by allocation of the inventory to the co-functions (illustrative).** The thickness of the lines inside the process indicates which share of each non-functional flow is allocated to each of the two co-functions (here: "Product A" and "Product B"). The flows can be quantitatively allocated to only one (blue, solid lines) or to several (red, dotted lines) of the co-functions. Different allocation criteria can be applied that need to be appropriately identified. The sum of the allocated amount of inventory flows shall be identical to the un-allocated inventory of the process.

In practice there is often the difficulty to clearly identify the most appropriate allocation key, as the following examples illustrate. There is also often a lack of data (e.g. in the above example case data on how a varying amount of carbon and chlorine in the waste quantitatively changes effects the amount of dioxin formation), what renders the use of physical causality as solemn allocation criteria not always feasible or at least reduces the robustness. In chapter 7.9.3.2 some examples are given to illustrate this.

### On using the market price as allocation criterion

The use of the market price as allocation criterion is hence often found in practice. In many cases however the co-products are not directly traded but further processed internally e.g. compressed, purified, packaged etc. first. Hence the market price of the resulting product that is sold is to be adjusted (i.e. reduced) for these additional steps, before using it as allocation key. Some interim co-products are not at all or at least seldom traded externally (e.g. refinery gas); market price information is to be approximated in such cases. Market

<sup>51</sup> Note that the use of e.g. the lower calorific value for allocation across refinery products for the black-box unit process refinery is not a causal physical relationship, but a simplified allocation of a not causal physical relationship in the sense of ISO.

price based allocation on site level (i.e. of black box unit processes) disregards that emission abatement technologies often treat emissions that are related to only one of the co-products. A general disadvantage of using market prices in allocation is that this assumes a positive correlation of impacts with the market price, disregarding that environmental measures such as emission reduction technologies in fact increase the production cost while reducing the environmental burden. Using the market price for allocation also leads to some degree of correlation of the environmental impact with the price of the product, what limits the meaningfulness of such environmental impact data in eco-efficiency analysis.

### **The ILCD provisions solving multifunctionality of processes**

How to identify the most appropriate, specific allocation and substitution approaches is detailed in the following subchapters for the general cases.

## **6.5.4 LCI modelling provisions for Situations A, B, and C**

(Refers to aspects of ISO 14044:2006 chapter 4.3.4 and 4.2.3.6.1)

### **6.5.4.1 Introduction and overview**

In preparation of identifying the most appropriate LCI modelling principles and method approaches oriented to the goal of the LCI/LCA study, in chapter 5.3 the LCA work to be performed has been classified as belonging to one of three distinct decision-context situations A, B, or C.

In practice and next to the formal decision-context there is a wide range of other aspects that finally determine the most appropriate LCI modelling principles and method approaches to be applied. These aspects comprise among others reproducibility, information and data availability, precision and robustness, practicality, communicability, cost-effectiveness, coherence with other instruments, and stakeholder acceptance. Taking into account all these aspects, the modelling provisions for Situations A, B, and C are derived, as follows:

### **6.5.4.2 Situation A: "Micro-level decision support"**

(Refers to aspects of ISO 14044:2006 chapter 4.3.4 and 4.2.3.6.1)

#### **6.5.4.2.1 Overview**

Situation A relates to a life cycle based decision support on micro-level (e.g. for product-related questions). It is typically, but not necessarily referring to the short-term (up to 5 years from present) or mid-term (5 to 10 years from present) future. I.e. the analysed changes directly or indirectly relate to inform the purchase of products that are already offered in the market or the design / development of products that are foreseen to entering the market typically. Key criteria is that the analysed e.g. product has a limited share of the total production of its sector, so that its production, use and end-of-life can be reasonably expected to have no large-scale consequences in terms of additionally installed or reduced capacity in the background system or other systems, i.e. not structurally change it<sup>52</sup>.

- 
1. <sup>52</sup> Sometimes it is theoretically assumed that any small-scale decision would have long-term consequences on installed capacity (e.g. the purchase of 500 polypropylene-based ball pens would result in marginally increased capacity of polypropylen production by resulting in a marginal extra of newly installed polypropylene plants). This is understood to need further research before it can be considered for inclusion under Situation A, as a valid, efficiently applicable and robust guidance is required. Especially investment decisions under market, policy and other constraints as well as the specific effect of secondary consequences that counteract or block any such large-scale consequences need to be better understood.

In condensed form and for orientation only, the following guidance is given: The most appropriate LCI model for Situation A shall represent the supply-chain of the analysed system, applying attributional modelling. For cases of system-system relationship and multifunctionality of processes and products that cannot be solved by subdivision or virtual subdivision, the system expansion approach shall be adopted, substituting the avoided process as its market mix (excluding the to-be-substituted function/route). Value-correction may be needed to adjust for differences in performance. In the case of large complexity, allocation is the next option to solve multifunctionality.

The following paragraphs provide further details. Details on modelling are given in the respective Life Cycle Inventory chapters.

#### 6.5.4.2.2 LCI modelling provisions

##### General life cycle model

The following general guidance shall be applied:

- attributional modelling shall be used for the general system LCI modelling, i.e. depicting the existing supply-chain, use and end-of-life downstream chain, as for the given to be included in the model.

##### Multifunctionality

For solving multifunctionality, subdivision or virtual subdivision shall be aimed at, cutting free non-multifunctional processes (see chapter 6.5.3). For system-system relationships and for solving multifunctionality where this is principally not possible OR where other reasons such as data availability or cost considerations hamper this, the appropriate LCI method approaches shall be:

- Cases of system-system relationship (see box in chapter 7.2.2): if the secondary function acts within another system where it only affects the existing processes' operation (and potentially also the installed capacity, e.g. because this secondary function had been considered when planning the affected system), system expansion shall be done via substitution of the short-term marginal. In more detail: the system-system relationship related multifunctionality does not lead to installation of new processes or their taking out of operation, but only to changes in their operation (i.e. 'short-term marginal' consequences). This is given for those cases where the secondary function of the analysed product acts directly in context of another system, the 'context system'. An example is a coffee-machine that generates heat as co-function that lowers the heating demand for the building in which it is operated (and/or increases the cooling demand, depending on the region and season) (details see box of system-system relationships in chapter 7.2.2). The superseded process is hence directly the one affected in its operation (e.g. in case of the above example the average house heating and cooling systems in the analysed country). Note that in case the existence of the coffee-machine was anticipated in the building design and the installation of heating/cooling capacity, the same applies, just that in that case other heating/cooling systems are in use and to be modelled.
- Cases of multifunctionality - general:
  - If for the not required co-function functionally equivalent alternative processes / products are operated / produced in a sufficient<sup>58</sup> extent, the not required co-function shall be substituted with the average market<sup>59</sup> consumption mix of the processes or products that are superseded, excluding the to-be-substituted process-route/product from this mix. The reasoning for this simplification compared to a full consequential

modelling is that a high effort is required to identify among the potential processes those that are most likely superseded and calculate the superseded mix: In full consequential modelling the mix of the most likely superseded processes would need to be identified. The limited benefit of a potentially more accurate, but also less certain selection of processes is not found justified for Situation A studies. The market mix is used as a realistic and robust approximation that additionally considers the existence of various secondary consequences and constraints that can be assumed to often reduce or fully compensate/avoid the theoretical primary consequences.

- If such alternative processes / systems do not exist or are not operated to a sufficient extent, alternative processes / systems of the not required co-function in a wider sense should be used for substitution, along the same provisions as set in the preceding sub-provision.
- If also such alternative processes / systems for the wider function do not exist or do not meet the named requirements, the study is in fact a Situation B type study, as this implies large-scale consequences on other systems: the amount of not required co-function is more than the market can easily absorb without structural changes
- It can be that modelling of substitution is not feasible. This can be e.g. as very many alternative processes / systems or alternatives for the function in a wider sense exist (e.g. over 10 alternative processes / systems make up over 80 % of the market for the to-be-substituted function and/or the superseded processes / systems themselves have a number of co-functions)). The effort for modelling and quality-controlling this system would counteract applicability and practicality for Situation A studies. For this reason a simplification is applicable, compared to the theoretical full consequential model: In such cases and also if otherwise usable generic data is not sufficiently accurate to represent the superseded processes / systems, the two-step allocation procedure of chapter 7.9.3 can be applied instead. This shall however not be done if it would relevantly favour the analysed process / system; this should be argued or approximated. Note that if allocation is done, the resulting lack of accuracy shall be reported and later be considered in the interpretation.
- Another simplification applies compared to the theoretical full consequential model: Substitution of the determining co-function(s) shall not be done. If they cannot be identified, the determining co-function(s) should be assumed to be those that jointly contribute more than 50 % to the combined market value of all co-functions of the analysed multifunctional process or system. That implies that in fact the main, determining co-function(s) of the process would be substituted. In this case, the two-step allocation procedure shall be applied (see chapter 7.9.3).
- Differences in functionality between substituted and superseded function shall be considered either and preferably by substituting the actually superseded amounts (e.g. the amount of Portland cement that the steel making co-product BOF slag actually replaces in cement). Or, as second priority, these differences shall be considered by market value correction of the amount of the substituted function and its inventory, i.e. the ratio of market price between the co-function and the ones it is supposed to supersede.
- As special case of the above, for waste and end-of-life treatment (for all cases, i.e. "closed loop", "open loop - same primary route", and "open loop - different primary route"): system expansion shall be done, substituting the avoided primary production using the recyclability substitution with the average primary route market mix of the

market where the secondary good is produced; differences in functionality shall be considered by substituting the actually superseded amounts or by market value correction (details see annex 14). An example: recycled, untreated wood from construction waste<sup>53</sup> might be chipped and used in particleboard production in Europe. Primary produced wood chips (European market consumption mix) would be superseded and their inventory used in substitution. If the secondary wood chips would have a lower functionality than the primary wood chips (e.g. more would be needed for a particleboard of the same performance specifications), the respectively reduced amounts of superseded primary wood-chips is substituted. Or, if this is not identifiably and quantifiable, but the market value of primary wood chips would differ to the secondary ones, the substituted inventory is corrected by their market price ratio. Any efforts of sorting, transport, chipping, etc. of the construction wood waste would be part of the building inventory from which the construction wood waste stems. The simplified substitution of the market mix of primary production is reasoned the same way as the use of the market mix for the general case of multifunctionality, as explained more above. An example is the electricity produced from production waste or end-of-life product incineration with energy recovery. The superseded and to be substituted process is the electricity mix of the market (e.g. country, region, sub-grid) where the waste / end-of-life treatment takes place, excluding the to-be-substituted electricity source

- Especially for the case of "open loop - different primary route" in addition it shall be checked whether for the reused part, recycled material, or recovered energy functionally equivalent, alternative processes / systems, or functional equivalents in a wider sense exist and are operated to a sufficient extent (as detailed above for the general cases of multifunctionality). Otherwise, the study is in fact a Situation B type study, as this implies large-scale consequences on other systems. Analogously to the general case of multifunctionality, the amount of secondary good provided is so high that the market cannot absorb it without structural changes. Note that this usually does not apply to closed-loop cases, as the secondary good enters the same kind of system, i.e. the market can always absorb the secondary good. This is unless the quality is too low and it cannot replace the functions of the primary good.
- Similarly as for the general case, very complex and expanded substitution systems can render the study impractical, as data is not available or accessible for all parts, or lead to inappropriately high costs. In that case (see above), allocation can be done, applying the procedure for waste / end-of-life treatment multifunctionality; this is detailed in annex 14.4 and chapter 7.9.3. Allocation shall however not be done if it would relevantly favour the analysed process / system. This can be analysed qualitatively or semi-quantitatively argued or approximated. If allocation is done, the resulting lack of accuracy shall be reported and later be considered in the interpretation.

### Comparative studies

For comparative studies of Situation A the main model for each of the compared alternatives shall be complemented with assumption scenarios of reasonably best and reasonably worst cases and (optionally) further assumption scenarios within the reasonably best and worst cases. Uncertainty calculation shall be performed, unless it has already been

---

<sup>53</sup> Methodologically identically for wood waste collected during production of a building and from decommissioning of an old building.



used to derive the reasonably best and worst case scenarios. The interested parties shall be involved towards a best attainable consensus on the definition of the reasonably best and reasonably worst assumption scenarios that can in principle vary all data and method provisions and assumptions for Situation A, except for the "shall" provisions and assumptions.

Note that the comparative case under Situation A (e.g. procurement of cleaning services) in most cases assumes that one of the compared alternatives will be procured. The LCA-based decision support hence only compares the alternatives. There is hence usually no 'zero' option.

If among the to-be-compared systems, one or more systems have additional functional units, comparability shall be achieved by system expansion.

### 6.5.4.3 Situation B: "Meso/macro-level decision support"

(Refers to aspects of ISO 14044:2006 chapter 4.3.4 and 4.2.3.6.1)

#### 6.5.4.3.1 Overview

Situation B refers to life cycle based decision support on a meso or macro-level, such as for strategies (e.g. raw materials strategies, technology scenarios, policy options, etc.). It typically refers to the mid-term (5 to 10 years from present) or long-term (beyond 10 years from present) future, given the nature of the study. Key criterion is that the analysed decision has consequences on changes in production, use and end-of-life activities that will directly or indirectly change relevant parts of the economy by having large-scale structural effects.

In condensed form and for orientation only, the following guidance is given: The analysed systems or alternative scenarios shall be modelled, applying the modelling guidance of Situation A (see chapter 6.5.4.2). Those processes that have been identified as being affected by "big" large-scale changes as consequence of the analysed decision shall be modelled as the market mix of the long-term marginal processes (details see chapter 7.2.4). This shall be complemented with assumption scenarios of reasonably best and reasonably worst cases. Also uncertainty calculation can support the analysis.

The following paragraphs provide further details with the full details are given in the respective chapters:

#### 6.5.4.3.2 LCI modelling provisions

##### General life cycle model and multifunctionality

Situation B shall apply the LCI modelling guidance of Situation A, with one exception: processes that have been identified as being affected by big<sup>54</sup> changes as consequence of the analysed decision shall be modelled as mix of the long-term marginal processes.

##### Comparative studies

Comparisons of alternatives would then be made among the various alternatives, considering the assumption scenarios and uncertainty analysis (unless such has already been used to derive the reasonably best and worst case scenarios).

Note that in contrast to Situation A, the comparative case (e.g. options for recycling policies) in most cases also has a 'zero' option of 'business as usual', i.e. that a new policy

---

<sup>54</sup> Definition and guidance see chapter 7.2.4.

would not be put in place (or that no change would be made to an existing policy). The LCA-based decision support hence usually also has one scenario of 'no action'.

For comparative studies the systems or alternative scenarios shall be complemented each with further scenarios (here called "assumption scenarios") to improve the robustness of the analysis, by varying the key data related assumptions (e.g. recycling rates, use intensity, life times, etc.) and potentially the relevant method assumptions. The assumption scenarios shall combine variations of the most influencing assumptions aiming at representing reasonable worst and reasonable best cases around the system(s).

These reasonable worst and reasonable best cases should be derived by expert judgement aiming at capturing the upper and lower 90 % percentile of error around the system / alternative scenario (including accounting for co-variance among assumptions). This scenario analysis shall be combined or integrated with stochastic uncertainty calculation e.g. applying Monte-Carlo Simulation, unless such has already been used to derive the reasonably best and worst case scenarios.

The assumption scenarios may deviate from all LCI modelling requirements of Situation B, including the "shall". The necessary reasonable worst and reasonable best scenarios shall be agreed among the involved interested parties of a public stakeholder hearing aiming at the best attainable consensus<sup>55</sup>. These scenarios can hence include e.g. full consequential scenarios for the entire system life cycle and attributional (allocation) for cases of multifunctionality. Details on which consequences should be included by default in case consequential modelling is done and guidance on determination of the marginal processes is found briefly in chapter 7.2.4.

If an LCI data set is the deliverable of the study, the modelling of assumption scenarios is recommended, only. If performed, the outcome may be documented together with the data set. Note that this is a "shall" requirement if the data set is intended to be used in subsequent comparisons.

#### 6.5.4.4 Situation C: "Accounting"

(Refers to aspects of ISO 14044:2006 chapter 4.3.4 and 4.2.3.6.1)

##### Overview

Situation C relates to studies that require an entirely descriptive, accounting-type of life cycle model, typically referring to the past or present (while individually also to the future via extrapolation). The object of the analysis can be both on a micro-level and on a meso or macro-level; the amount of production or consumption and of co-functions does not change the modelling. Key difference from Situations A and B is that the study is interested in documenting what has happened (or will happen) based on decisions that have already been taken; there is hence no small-scale or large-scale consequences on the background system or other systems in the rest of the society that would be in the interest of the analysis. However, existing benefits and negative interactions with other systems (e.g. recycling credits) may be included. This leads to the two differentiated cases C1 and C2.

For the two sub-types of Situation C, the key difference is whether existing benefits outside the analysed system are considered or not: In Situation C1, this is the case (e.g. the

---

<sup>55</sup> As the review requirements for such Situation B studies foresee an external review (for the exact type of review see the review guidance document), it is one possibility to fulfil this hearing requirement by joining it with the stakeholder involvement in this review: the reviewer / review chair can invite affected stakeholders and steer a process towards the best attainable consensus on the primary and secondary consequences that are to be included into the scenarios of the respective study.

benefit of a process of the analysed system is producing a co-product that actually supersedes another product). This is hence to be credited. Note that in difference to Situation A (or B), here this benefit is already existing (as an existing system is described). In Situation A (or B) this benefit is assumed to occur only in consequence of the decision that is supported with the study, i.e. in addition. This "addition" is the key: only if the additional amount of co-product can be used in the market, only then the crediting is appropriate in Situation A, otherwise the structural consequences are to be modelled (Situation B). For that reason in Situation A, the credit is only given if it can be shown that the superseding actually takes place (or is likely to take place as the amount is relatively small). In Situation C1, the fact of superseding can actually be measured by inventorying how much of the co-product is actually used and for which purposes and how much may be deposited. This results in the following, general modelling provision:

### LCI modelling provisions

For both Situation C1 and C2 the life cycle of the analysed system(s) shall be modelled as attributional model of the supply-chain, i.e. as in Situation A (details see chapter 7.2.3; see also again 6.5.2).

### Multifunctionality

For solving multifunctionality, subdivision or virtual subdivision shall be aimed at, cutting free non-multifunctional processes (see chapter 6.5.3). For system-system relationships and for solving multifunctionality where this is principally not possible OR where other reasons such as data availability or cost considerations hamper this, the appropriate LCI method approaches shall be:

- For Situation C1 multifunctionality of processes and systems should be solved with substitution via system expansion, similarly as in Situation A but independently of the amount of secondary function. That means that studies done under Situation A are identical to studies done under Situation C1 (while not vice versa).
- For Situation C2, multifunctionality of processes and systems shall be solved with allocation. This also applies to all end-of-life product and waste management including material recycling, energy recovery, part reuse, product further use, etc. The guidance on the two-step procedure for applying allocation is provided in chapter 7.9.3. Details on modelling recycling are provided in annex 14.4.

Note that given the purely descriptive character of the model, the resulting accounting-type data of Situation C1 – while informing decision makers about developments and hot spots – cannot DIRECTLY be used for decision support or comparisons of alternative measures: this requires the subsequent use of the modelling under Situation A or B.

### Provisions: 6.5.4 LCI modelling provisions for Situations A, B, and C

The following modelling provisions can be applied only in the Life Cycle Inventory phase. However, because the step of determining the LCI modelling and method approaches is part of the scope definition, the provisions are given here. They are also required to provide orientation to some of the remaining steps of the scope phase.

Note that the inventory of a unit process is basically identical for Situation A, B, and C, although some differences apply e.g. for required additional information, e.g. market size. What differs is which processes are within the system boundary, especially in the background system (what is addressed in chapter 7.2), and how the processes are combined to represent the life cycle model and how multifunctionality is solved; both are addressed in this chapter.

The following provisions draw on the provisions in the referenced LCI chapters. They are partly simplified compared to the 'full' consequential and attributional modelling provisions to improve practicality and applicability;

## Provisions: 6.5.4 LCI modelling provisions for Situations A, B, and C

this is highlighted in the respective provision.

- l) **SHALL - LCI modelling provisions to be applied:** A specific combination of LCI modelling framework (attributorial or consequential) and LCI method approaches (allocation or system expansion / substitution) is identified for each of the goal situations A, B, C1, and C2. The provisions cover scenario and uncertainty calculation. The provisions shall be applied as follows (6.5.4.1): [ISO!]

### I.a) **Situation A - "Micro-level decision support":** (6.5.4.2)

I.a.i) **Life cycle model:** The life cycle model of the analysed system(s)<sup>56</sup> shall be modelled as an attributorial model, i.e. depicting the existing supply-chain processes (for details see chapter 7.2.3).

I.a.ii) **Subdivision and virtual subdivision for black box unit processes and multifunctionality:** It shall be aimed at avoiding black box unit processes and solving multifunctionality by subdivision or virtual subdivision (see chapter 7.4.2.2), as far as possible. The following applies for cases of system-system relationships and cases of multifunctionality, if subdivision / virtual subdivision is not possible or not feasible:

I.a.iii) **Cases of system-system relationship:** if the analysed system's secondary function acts within a context system, where it only affects the existing processes' operation, system expansion shall be performed via substitution with the short-term marginal (for terms, concepts, and details see boxes in chapter 7.2.2 and chapter 7.2.3).

Note that the analysed system may also have influenced the installed capacity of the context system, if it had been considered when planning the context system. For example the heat generated by office equipment may have been considered when dimensioning the heating and cooling system of an office building.

Part-system relationships require no specific modelling provision, but the correct identification of the processes within the system boundary; see boxes in chapter 7.2.2.

I.a.iv) **Cases of multifunctionality - general:** (For terms, concepts, and details see chapter 7.2.4.6, but note the simplifications given here for Situation A):

I.a.iv.1) **Substitution of market mix of specific alternatives:** (Simplification compared to full consequential model): If for the not required<sup>57</sup> specific co-function, functionally equivalent alternative processes / systems are operated / produced to a

<sup>56</sup> Plural in case of comparisons.

<sup>57</sup> I.e. in contrast to the one that is analysed or within the system boundary in the background system.

### Provisions: 6.5.4 LCI modelling provisions for Situations A, B, and C

sufficient<sup>58</sup> extent: the not required co-function shall, as far as possible, be substituted with the average market<sup>59</sup> consumption mix of the processes or systems that it supersedes, excluding the to-be-substituted function from this mix. If the to-be-substituted function has a small share in the overall environmental impact of the market mix, the market mix can be used instead, if the results are not relevantly changed.

- I.a.iv.2) **Substitution of market mix of general, wider alternatives:** If such alternative processes / systems do not exist<sup>60</sup> or are not operated to a sufficient extent, alternative processes / systems of the not required co-function in a wider sense should be used for substitution<sup>61</sup>, applying the same provisions as set out in the preceding sub-provision.
- I.a.iv.3) **Situation B?:** If also such alternative processes / systems for the wider function do not exist or do not meet the named requirements, the study is in fact a Situation B type study, as this implies large-scale consequences on other systems.
- I.a.iv.4) **Allocation:** (Simplification compared to full consequential model): if modelling of substitution is not feasible<sup>62</sup> and generic data is not sufficiently accurate to represent the superseded processes / systems: the two-step allocation procedure of

<sup>58</sup> "Sufficient" means that the not required co-function can quantitatively be absorbed by the market. That shall be assumed to be the case, if the annually available amount of the to-be-substituted co-function is not more than the annual amount produced by the annually replaced installed capacity of the superseded alternative process(es) or system(s) (see also paragraph on "Guidance for differentiating between Situation A and B" in chapter 5.3.6). ! Note that this refers to the amount of co-function provided by the analysed process. E.g. if the study refers to a specific producer that contributes only a small share to the total production of the co-function, only this small amount counts. I.e. it is very likely that it can be absorbed by the market. If the study refers to the total production of a certain product that has the not required co-products, there is the chance that this much larger amount of co-products cannot be absorbed by the market.

<sup>59</sup> This "market" is the market where the secondary function is provided. E.g. for products produced from end-of-life and waste management this is the market of the primary production at the time and the location (e.g. country, region or global etc. market) where the end-of-life product or waste is known or forecasted to undergo recycling, reuse, or energy-recovery. If this market cannot be clearly determined, the most likely market shall be assumed and well justified; this most likely market shall be on a continental scale or at least cover a group of countries / markets. For explanation of the "market" concept see chapter 6.8.3.

<sup>60</sup> As is the case e.g. for wheat grain and straw production, many oil refinery products, etc.

<sup>61</sup> E.g. for NaOH, as co-product of Chlorine production, apart from NaCl electrolysis no alternative route is operated to the sufficient extent. However, NaOH provides in a wider sense the function of neutralising agent (next to some other, quantitatively less relevant functions) and hence other, technically equivalent and competing neutralising agents such as KOH, Ca(OH)<sub>2</sub>, Na<sub>2</sub>CO<sub>3</sub>, etc. can be assumed to be superseded; their mix would be used to substitute the not required NaOH. For the example of a wheat grain study and the not required co-product straw: instead of straw, other dry biomass (e.g. Miscanthus grass, wood for heating, etc.) provides equivalent functions and its market mix can be assumed to be superseded.

<sup>62</sup> "not feasible" refers to cases where many alternative processes / systems or alternatives for the function in a wider sense exist (e.g. where over 10 alternative processes / systems make up over 80 % of the market for the to-be-substituted function, and/or where the superseded processes / systems themselves have a number of co-functions).

### Provisions: 6.5.4 LCI modelling provisions for Situations A, B, and C

chapter 7.9.3 can be applied instead. Allocation shall however not be performed if it would relevantly favour the analysed process / system. This fact shall be argued or approximated. If allocation is performed, the resulting lack of accuracy shall be reported and explicitly be considered later in the results interpretation. For multifunctional products and the alternative second step in allocation, Quality Function Deployment (QFD) is the preferred alternative to market price allocation.

- I.a.iv.5) **No substitution of main function(s):** (Simplification compared to full consequential model): The determining co-function(s) shall not be substituted (for term and concept see chapter 7.2.4.3). In the case the determining and dependent co-functions cannot be clearly identified, the determining co-function(s) should be assumed to be those that jointly contribute more than 50 % to the combined market value of all co-functions of the analysed multifunctional process or system<sup>63</sup>. (The market value is for this purpose the value of the co-functions as provided by the multifunctional process, i.e. without any further processing). In this case, the two-step allocation procedure shall be applied (see chapter 7.9.3).
- I.a.iv.6) **Considering functional differences:** Differences in functionality between substituted and superseded function shall be considered either preferably by substituting the actually superseded amounts, or by substituting the market value corrected amount of the function (details see chapter 7.2.4.6).
- I.a.v) **Cases of multifunctionality - waste and end-of-life treatment:** (For terms, concepts, and details see chapter 7.2.4.6 and annex 14.5, but note the simplifications given here for Situation A):
- I.a.v.1) **Recyclability substitution of primary route market mix:** (Simplification compared to full consequential model): For waste and end-of-life treatment as cases of multifunctionality: system expansion shall be performed in accordance with the provisions for the cases of general multifunctionality. The avoided primary production of the reused part, recycled good, or recovered energy shall be substituted. This shall apply the recyclability substitution approach, with the simplification of substituting the average primary route market consumption mix of the market where the secondary good is produced.
- I.a.v.2) **Recyclability substitution of general, wider alternatives:** For "open loop - different primary route" cases, the market consumption mix of alternative goods in a wider sense should be used for substitution, along the same provisions as set out in the preceding sub-provision.

<sup>63</sup> The reasoning is that in that case it is likely that the determining co-functions would be substituted.

### Provisions: 6.5.4 LCI modelling provisions for Situations A, B, and C

- I.a.v.3) **Situation B?:** Especially for the case of "open loop - different primary route" and for secondary goods with relevantly changed / downcycled properties, in addition verification is needed on whether for the reused part, recycled material, or recovered energy, functionally equivalent, alternative processes or systems, or functional equivalents in a wider sense exist. If this is the case it needs additional verification whether these are operated to a sufficient extent (as detailed above for the general cases of multifunctionality, see also footnote 58). Otherwise, the study is in fact a Situation B type study, as this implies large-scale consequences on other systems.
- I.a.v.4) **Allocation:** (Simplification compared to full consequential model): if modelling the substitution is not feasible (see footnote 62) and generic data is not sufficiently accurate to represent the superseded processes / systems, then the two-step allocation procedure applied to waste/end-of-life given in annex 14.5 and chapter 7.9.3 can be applied instead. This shall not be done if it would relevantly favour the analysed process / system; this fact shall be argued or approximated. If allocation is performed, the resulting lack of accuracy shall be reported and explicitly be considered later in the results interpretation.
- I.a.v.5) **Considering functional differences:** Differences in functionality between substituted and superseded function shall be considered either and preferably by substituting the actually superseded amounts. As second priority and if the superseded amounts are not known, market value correction of the amount of the substituted function shall be performed.

Note that this applies to all cases of waste and end-of-life treatment that generate any valuable secondary good, i.e. "closed loop", "open loop - same primary route", and "open loop - different primary route" (concepts see 14.3).

- I.a.vi) **Comparative studies, scenarios, uncertainty calculation:**
- I.a.vi.1) If among the to-be-compared systems, one or more systems have additional functional units, comparability shall be achieved by system expansion.
- I.a.vi.2) For comparative studies of Situation A, the main model for each of the compared alternatives shall each be complemented with assumption scenarios of reasonably best and reasonably worst cases. Optionally further assumption scenarios can be defined. Uncertainty calculation shall be performed, unless it has already been used to derive the reasonably best and worst case scenarios. These scenarios serve to later perform the sensitivity check (see chapter 9.3.3). The interested parties shall be involved towards a best attainable consensus on the definition of the reasonably best and reasonably worst case assumption scenarios (and uncertainty calculation) that can in principle vary all data and method provisions and assumptions

## Provisions: 6.5.4 LCI modelling provisions for Situations A, B, and C

for Situation A **except for** the "shall" provisions and assumptions / conventions. It is recommended to also perform and report such assumption scenarios and uncertainty calculations for non-comparative LCI and LCA studies.

Note that for LCI data sets that are intended to support comparative studies, the reasonably best and worst case scenarios may be included within these data sets or be provided as complement.

### I.b) Situation B "Meso/macro-level decision support" (6.5.4.3):

I.b.i) **Provisions as for Situation A with two differences:** The above provisions for Situation A shall also be applied for Situation B, with two differences:

I.b.i.1) **Large-scale consequences:** Processes that have been identified as being affected by "big"<sup>64</sup> large-scale changes as a consequence of the analysed decision shall be modelled as the expected mix of the long-term marginal processes (for details see chapter 7.2.4).

I.b.i.2) **Comparative studies, scenarios, uncertainty calculation:** (Additional flexibility for assumption scenarios), for comparative studies of Situation B: The assumption scenarios and uncertainty calculation can in principle vary all data and method provisions and assumptions for Situation B **including** the "shall" provisions and assumptions / conventions of the ILCD Handbook, while not those of ISO 14040 and 14044<sup>65</sup>.

Note that comparative Situation B studies often include a "zero" option, i.e. include a scenario of "no action" (e.g. "no change in existing policy Y", or "no strategic measure on raw material X security of supply").

### I.c) Situation C - "Accounting" (6.5.4.4):

I.c.i) **Provisions as for Situation A with two differences:** The provisions for Situation A shall also be applied for Situation C. With two differences:

I.c.ii) **Remaining cases of multifunctionality:** These shall be solved as follows:

I.c.ii.1) **Situation C1:** Multifunctionality of processes and systems shall be solved with substitution via system expansion, as in Situation A, but independently of the absolute amount of the not

<sup>64</sup> Large-scale ("big") consequences shall generally be assumed if the annual additional demand or supply that is triggered by the analysed decision exceeds the capacity of the annually replaced installed capacity of the additionally demanded or supplied process, product, or broader function, as applicable (see also chapter 5.3.6, under the paragraph heading "Guidance for clearly differentiating between Situation A and B").

<sup>65</sup> I.e. these scenarios and uncertainty calculation allow to apply the full range of method and modelling options of ISO 14044.



### Provisions: 6.5.4 LCI modelling provisions for Situations A, B, and C

required co-function(s) that will be substituted<sup>66</sup>. The other provisions apply analogously.

I.c.ii.2) **Situation C2:** General cases of multifunctionality of processes and systems shall be solved with allocation (i.e. applying the two-step allocation procedure; for details see chapter 7.9.3). Cases of waste and end-of-life treatment shall be solved via allocation, as described in annex 14.4.1 (with the provisions being included in the 'Provisions' of chapter 7.9.3).

I.c.iii) **Comparative studies:** Note the restrictions for direct comparative decision support of accounting data (see chapter 5.3.7).

Note that Situation C1 is thereby modelled identically to Situation A, while independently of the size of the system or processes.

Note that substitution can lead to negative elementary flows or in rare cases even negative overall environmental impacts of the analysed systems. This must be explicitly addressed in reporting, explaining all implications and helping to avoid misinterpretation and misleading conclusions.

The main guidance on attributional LCI modelling is given in chapter 7.2.3.

Guidance on the two-step procedure for applying allocation is provided in chapter 7.9.3.

Main guidance on consequential LCI modelling is given in chapter 7.2.4.

Details on LCI modelling of reuse/recycling/recovery are provided in annex 14.4 (attributional) and annex 14.5 (consequential).

## 6.6 Deriving system boundaries and cut-off criteria (completeness)

(Refers to ISO 14044:2006 chapters 4.2.3.3.1, 4.2.3.3.2, AND 4.2.3.3.3)

### 6.6.1 Introduction and overview

(Refers to ISO 14044:2006 chapter 4.2.3.3.1)

#### Overview

The system boundaries define which parts of the life cycle and which processes belong to the analysed system, i.e. are required for providing its function as defined by its functional unit. They hence separate the analysed system from the rest of the technosphere. At the same time, the system boundaries also define the boundary between the analysed system and the ecosphere, i.e. define across which boundary the exchange of elementary flows with nature takes place<sup>67</sup>.

<sup>66</sup> The reasoning is that the effect of superseding alternative processes / systems is existing, other than in Situation A where an additional amount of co-function is pushed into the market. I.e. in Situation C1, the check whether alternative processes / systems are operated or produced to a sufficient extent is unnecessary, as the superseding factually already occurs.

<sup>67</sup> This is not always straightforward, e.g. for agricultural systems that need a clear definition where the technosphere (i.e. the managed field) ends and nature begins. See chapter 7.4.4.1.

**Terms and concepts: Technosphere and ecosphere – clearer defining the boundary**

The terms technosphere and ecosphere are central and it can often be observed that these two terms are interpreted differently by different practitioners: in ISO 14044:2006 the ecosphere is referred to as “*environment*” what can be confusing as in LCA practice e.g. also buildings and dams are referred to as “*man-made environment*”. In addition, the elementary flows that cross the system boundary are defined as “*material or energy entering the system being studied that has been drawn from the environment without previous human transformation, or material or energy leaving the system being studied that is released into the environment without subsequent human transformation*”. This brings ambiguity in cases such as e.g. tailings from ore mining, fertiliser applied in agriculture, but also non-managed waste land-filling in general as such 'materials' are sometimes wrongly interpreted as being an elementary flow to the environment.

The difficulty of impact assessment of complex flows such as land-filled end-of-life products or tailings is that LCIA relates to single substances and energy flows. In order to ensure reproducibility and an appropriate and working link with impact assessment it is necessary to completely model the named cases until emissions of single substances enter the natural environment. I.e. instead of inventorying “tailings” (which moreover can mean very different things in practice and for which no impact factors exist) the leaching of e.g. sulphuric acid and specific metals from the tailings is to be modelled and inventoried as “Emissions to water”. The same applies to land-filled waste with both the emissions accounted for and the resources/products to operate the land-fill (if any). The boundary technosphere / ecosphere can hence be more suitably be defined by defining the elementary flow as “*single substance<sup>68</sup> or energy entering the system being studied that has been drawn from the ecosphere without previous human transformation, or single substance or energy leaving the system being studied that is released into the ecosphere without subsequent human transformation*”.

A precise definition of the system boundaries is important to ensure that all attributable or consequential processes are actually included in the modelled system and that all relevant potential impacts on the environment are appropriately covered.

The levels of cut-off criteria and the maximum permissible uncertainty are - together with the achieved technical, geographical and time-related representativeness as well as method consistency - the key measure for the overall quality (i.e. accuracy, completeness, and precision) of the outcomes of the LCI/LCA study.

---

<sup>68</sup> Note that while not being single substances, sum indicators such as VOC, COD can be addressed in LCIA by assuming a breakdown list of single substances. While the inventorying of actual single substances is to be preferred, LCIA can be operationalised also with such sum indicators (as long as they are sufficiently homogenous). Analogous considerations apply for energy resources such as e.g. hard coal. See however also chapter 7.4.3 on this and other overarching LCI modelling and inventorying issues.

## Limitations of the system scope of the LCA approach (Accidents and other non-LCA impacts)

Note that LCA only accounts for impacts related to normal and abnormal operation of processes and products, but not covering e.g. impacts from accidents, spills, and similar<sup>69</sup>.

The health impact (or improvement) that products may directly exert on humans is equally not covered by LCA. This is because these impacts (or beneficial effects) occur within the technosphere and are not subject to any environmental fate and exposure chain. This applies to the use stage of a range of products such as food and drink, personal hygiene, healthcare products, tobacco products, etc. Use-phase related impacts that these products exert via an emission to the ecosphere (e.g. smoke emissions to the environment, wastewater-discharge) are however to be included.

Equally, not explicitly addressed are impacts that occur directly within the technosphere (e.g. workplace exposure)<sup>70</sup>. In summary, accidents, social and other work environment aspects including workplace-exposure, and indoor-emissions are not normally covered by LCA (and not addressed in this guidance).

If included they must be inventoried, aggregated and interpreted separately from the life cycle inventory that relates to inventions between the technosphere and the ecosphere and related to normal operation of the involved processes.

### Limited guidance in ISO on types of processes to include in attributional modelling

In ISO this step is only addressed implicitly for attributional modelling; no clear guidance is given which activities or processes actually relate to the analysed system. While it is generally agreed that extraction and direct processing of a material that ends up in the analysed good is part of the system, the general inclusion of investment goods, administration activities, marketing services, staff commuting, etc. is done differently by different practitioners.

In any case depends the setting of the system boundaries on the LCI modelling framework: in case of attributional modelling the system is modelled as it is, following a existing or forecasted, specific or averaged supply-chain logic.

In consequential modelling, in contrast, the consequences that the analysed system exerts on other systems are modelled, why these are the processes of a theoretically modelled supply-chain are to be included in the system boundaries. For consequential modelling, the informative ISO/TR 14049 gives illustrative guidance on the identification of these processes. This serves as starting point for updated and further detailed guidance; see chapter 7.2.4.

---

<sup>69</sup> Accidents and accident-type leakages and spills shall not be inventoried as part of the normal life cycle inventory since they are fundamentally different in nature from the production or operation related normal and abnormal operating conditions that LCA relates to (OTHER than e.g. fugitive emissions through sealings and other “engineered losses” that are included in LCA). Accident modelling necessarily requires dealing with frequencies and with cause-effect chains (to assign them to the causing unit processes). Work on this Life Cycle Accident Assessment is still under methodological development, while a number of explorative case-studies have been published.

<sup>70</sup> Methods to capture work-place exposure and other social work-place aspects are in between more advanced under the Life Cycle Working Environment approach, while still lack broader application in practice. Methodological work on indoor-exposure in private households is equally ongoing. It is unclear and widely discussed whether both these types of impacts inside the technosphere belong under “environmental impacts” or should be addressed separately, while within the same life cycle analysis frame. Within this ILCD guidance they are not addressed for the time being until methods have been advanced and more practice experience has been gained.

On a higher level, widely different practices are found in relation to a systematic inclusion or exclusion of accidents, the direct ingestion of food, application of e.g. cosmetics to the skin, indoor exposure at workplace and home, etc.

The basic guidance for the question which activities at all are to be related to a product or process are given in the LCI work chapters 7.2.3 and 7.2.4, separately for attributional and consequential modelling, respectively. This question is to be answered early in the scope phase as one basis for identifying principle data needs. The identification of the specific processes takes then place in the LCI phase of the LCA.

### System boundaries of unit process data sets

For unit process data sets and regarding product and waste flows, the system boundary is the boundary between the modelled process and the rest of the technosphere. I.e. all product and waste flows that enter or leave the process cross the boundary and hence appear in its inventory. Also all the elementary flows that directly leave the process towards the ecosphere or directly enter from there cross the system boundary are to be inventoried.

### System boundaries of LCI results, LCIA results, and LCA studies

For LCI result and LCIA result data sets and for full LCAs, the system boundaries should ideally be set in a way that all flows crossing the boundaries are exclusively elementary flows plus the reference (product) flow(s). In other words: all<sup>71</sup> other product and waste inputs and outputs should be completely modelled until the final inventories exclusively show elementary flows.

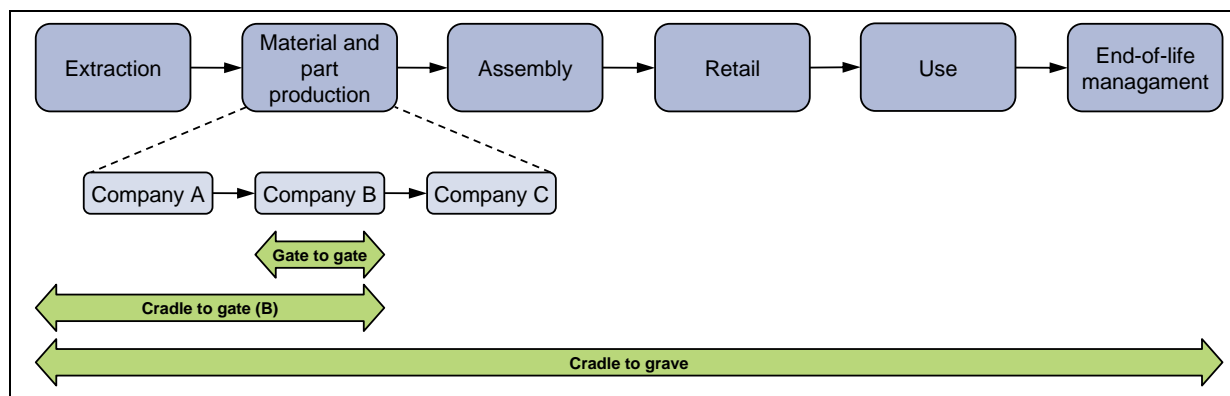

**Figure 12** Cradle to grave, cradle to gate and gate to gate data sets as parts of the complete life cycle; schematic. Each type fulfils a specific function as module for use in other LCA studies.

### Terms and concepts: Foreground system and background system

The analysed system is typically differentiated into the processes of the foreground system and those of the background system. Two different purposes are behind this differentiation that lead to two different concepts and usages, however: The first is the purpose of identifying where specific data should be used versus where average or generic background data can typically be used by default ("specificity perspective"). The second is the purpose of identifying which processes can be managed by direct control or decisive influence from the point of view of the decision-context of a study ("management perspective"). In context of this

<sup>71</sup> Note that exclusively for partly terminated systems selected product and/or waste flows may stay in the inventory; the life cycle data of these are then completed by the user of the data set.

guidance and for the purpose of data collection and compilation, the definition related to the "specificity perspective" is applied.

Note that the specificity perspective related distinction is only indicative, as key is the accuracy, precision and completeness of the data - especially generic data can for a given case be more suitable for the foreground system (see also chapter 7.4.2.5). Note that also for the management perspective related distinction many processes cannot be clearly assigned to either foreground or background, as they can only be partially influenced.

### Specificity perspective

**Definition foreground system:** In context of the "specificity perspective", the foreground system is defined as those processes of the system that are specific to it. This means that data for the specific e.g. technology, supplier etc. is most appropriate. These are in the example of a study on a producer-specific product the processes that are operated at the producer's facilities, but also all those processes at suppliers and downstream where only one or few operators are involved, i.e. where the specific processes cannot be replaced by e.g. market average supply data. These are hence typically the tier-one suppliers, but also suppliers more up the supply-chain, if specific relations exist, e.g. by using certified green energy or certified wood sources and the like.

**Definition background system:** The background system is then those processes, where due to the averaging effect across the suppliers, a homogenous market with average (or equivalent, generic data) can be assumed to appropriately represent the respective process. Use stage and end-of-life stage related processes belong hence to the background system from the perspective of the producer, in so far as the average use and end-of-life management processes are to be depicted. However, the specific characteristics of the product that is used and end-of-life treated are to be considered, hence combining specific properties with average/generic processes. Moreover, in case specific scenarios of use or end-of-life treatment technologies are investigated, these become part of the foreground system of the analysis and specific data is preferable.

### Management perspective

**Definition foreground system:** In context of the "management perspective", the foreground system is defined as those processes of the system that are regarding their selection or mode of operation directly affected by decisions analysed in the study. The foreground processes are hence those that are under direct control of the producer of the good or operator of the service or user of the good or where he has decisive influence. This variant of the foreground / background definitions is relevant for ecodesign studies. This covers firstly all in-house processes of the producer or service operator of the analysed system. Secondly, while only for attributional modelling<sup>72</sup>, also all processes at suppliers of purchased made-to-order goods and services, i.e. as far as the producer or service operator of the analysed

---

<sup>72</sup> Consequential modelling has no logic to depict existing supply-chains but models future supply-chains in consequence of the analysed decision (considering ideally constraints and secondary consequences): not the supplier-specific processes would be modelled but the general marginal / consequential processes, which at the most may consider certain supplier-characteristics (e.g. with which technology and in which country the supplier produces). It can even be in consequential modelling that processes under direct control of the producer or operator belong to the background system: That is if a specific decision is made that has consequences on other processes under direct control that are not directly decided upon but only via the consequence of the specific decision. That is unless a constraint applies that makes it unlikely that the concerned process is actually changed from its current technology in consequence of the analysed decision.

system can influence them by choice or specification<sup>73</sup>. Thirdly also all product and waste flows that cross the system internal boundary to the background system can be decided upon, as it can be decided which goods or services are purchased, even though the way how they are produced can be beyond this influence. Next, the use-phase is considered part of the foreground system from the perspective of the product developer in so far as the developer strongly influences the design-related use stage characteristics. Note that this influence exists, even though e.g. wholesale and retail may be processes in between production and use, and even though the use pattern influences the final inventory. Finally, also some key aspects of the end-of-life management of the product are part of the foreground system, as far as design-related properties (e.g. upgradability, reusability, disassemblability / recyclability, etc.) influence these processes. For attributional studies build around the use stage of consumer products, the foreground system would accordingly be the product use and the selection of the initial waste management (if the user has a choice of different options).

**Definition background system:** In contrast, the background system comprises those processes that are operated as part of the system but that are not under direct control or decisive influence of the producer of the good (or operator of the service, or user of the good). For attributional modelling these are typically processes at tier-two suppliers and beyond, both upstream and downstream the supply-chain. Examples are steel production for steel parts purchased by a manufacturer of computer-casings, or the production of the electricity used by a tier-one supplier of injection moulded plastic parts. The background processes and systems are hence outside the direct influence or choice of the producer or service operator of the analysed system.

This includes hence processes at those tier-one suppliers with which long-term contractual relations exist and which hence cannot be changed.

For consequential modelling the background system comprises everything except processes at the producer / operator and those tier-one suppliers with which long-term contractual relations exist and which hence cannot be changed.

The foreground and background system interact with each other directly by exchanging goods or services.

In a simple picture, the background system in attributional modelling of a certain market and moment in time (typically year) is the weighed average mix of the economy of that market and time into which the analysed system is embedded (and to which different processes it has quantitatively more or less relevant links via demand and supply). In consequential modelling the background system of a certain market and moment in time can be understood as the weighed future shift of the economy of that market at that moment or time-period (e.g. year ... decade), i.e. it is the quantitative mix of the newly installed and de-installed capacity of that market and during that time.

Figure 13 systematically illustrates the foreground and background system and the general system boundaries as well as the flows within and those that cross them.

---

<sup>73</sup> I.e. this can also include external waste management services purchased, as far as the product system producer/operator can choose the way the waste is managed (within technical and legal limits).

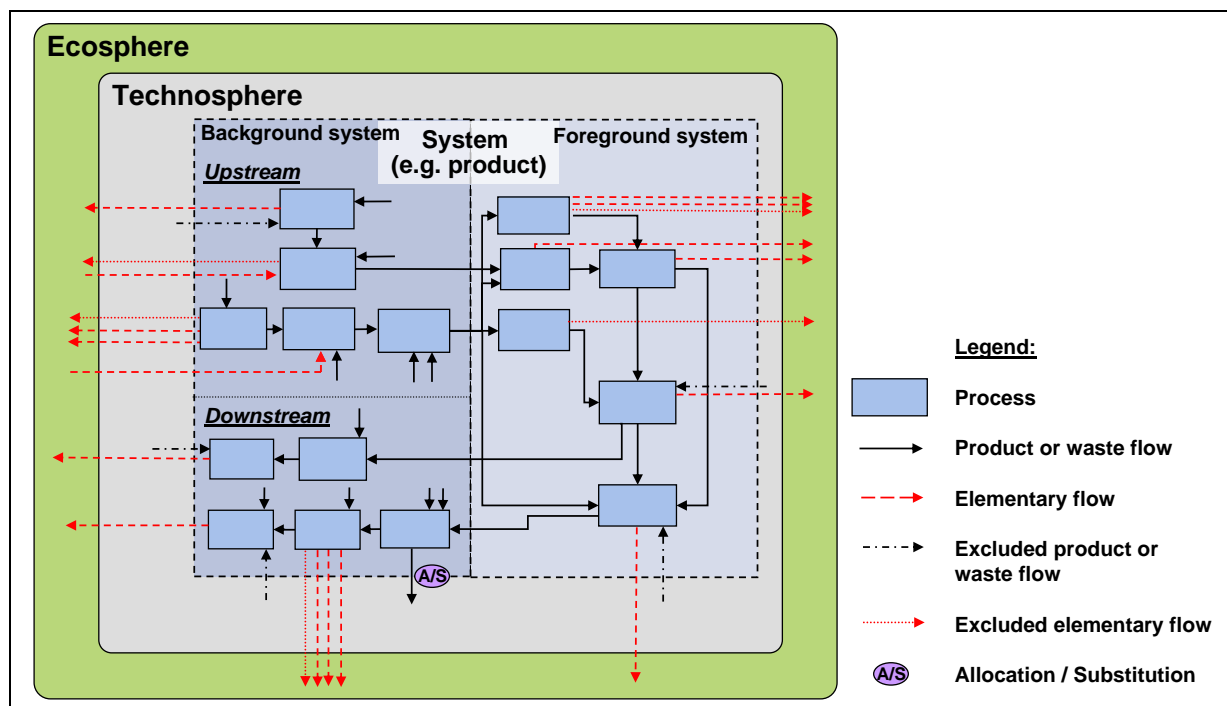

**Figure 13** Foreground system and background system in the specificity perspective (see box); (illustrative): The analysed system has boundaries (dashed border), separating it from the remainder of the technosphere and from the ecosphere. The system may be divided into the foreground system of processes that are specific to the analysed system i.e. own operations and fixed suppliers. The processes in the background system are not specific but purchased via a (theoretically fully homogenous) market. The system is the exact sum of the background and the foreground systems. Quantitatively irrelevant flows can be excluded, i.e. cut-off (dotted arrows).<sup>74</sup>

### Completeness / cut-off

In reality however, even for simple products, all economic activities globally are somehow part of the system. However, the number of processes that contribute in a quantitatively relevant degree to the system is typically rather limited, why this theoretical problem has little relevance in practice: In practice, all quantitatively not relevant non-reference product flows, waste flows, and elementary flows can be ignored - they are 'cut-off'<sup>75</sup>. Care must be taken that not more flows and related impacts are cut-off than acceptable to still meet the goal of e.g. a comparative study. Respectively, that the data sets that are used to model a system do meet this need of completeness. Chapter 6.6.3 provides further details on cut-offs.

### Loops

In addition, for system models virtually eternal loops exist: The production of e.g. steel requires coal, the extraction of which requires equipment made from steel, the production of which requires again coal, etc. These loops can be solved by LCA software either

<sup>74</sup> As the example shows a complete life cycle the system function is not shown; otherwise it would be represented by one flow that would leave from the last process step and cross the boundary to the rest of the technosphere. Note that the graphic is only illustrative and by no means complete. Also does the background system almost always contain a by far larger number of processes than does the foreground system.

<sup>75</sup> Note that this „incompleteness“ of the inventory is fully acceptable and has no consequences on the validity of the LCA, as the extent of the incompleteness (i.e. the quantitative cut-off criteria) are set in line with the goal and scope of the study.

mathematically or by iterative calculation of the inventories, which can be assumed to show a fast conversion of the values to stable numbers.

### **Towards an systematic qualitative and quantitative definition of the system boundaries**

Setting the system boundaries means deciding which life cycle stages, activity types, specific processes, and elementary flows to include and which to omit from the life cycle model. This has two aspects: A qualitative definition of what is needed to obtain the functional unit of the system and the setting of quantitative cut-off rules. Both are to be derived from the goal of the LCI/LCA study. The following subchapters explain these steps.

## **6.6.2 Qualitative definition of system boundaries**

(Refers to ISO 14044:2006 chapter 4.2.3.3.2)

### **Goal-oriented qualitative definition of the system boundaries**

The qualitative definition of the system boundaries shall identify those parts of the life cycle that are to be included to provide e.g. the required data set or to ensure a valid comparison in case of comparative studies.

E.g. in the comparative assertion on two different production routes to obtain “1 kg polyamide 6.6”, a cradle-to-gate model would be appropriate, leaving out other stages of the two compared systems (provided that the technical quality, including recyclability, of the two resulting products does not differ significantly). In contrast, in the comparative assertion on e.g. “1 l one-way PET bottles” vs. “1 l one-way glass bottles”, both “... for still water packaging for end-consumer storage and consumption”, also the transport of the bottles to the consumer would have to be considered as well as their end-of-life management (i.e. recycling or other treatment of the post-use bottles). A comparison of the bottles that would only cover cradle-to-gate would here hence be invalid as incompletely reflecting the different life cycle implications of the two alternatives: they have different transport implications and different end-of-life management that need to be included for valid decision support.

### **System boundaries - attributional vs. consequential modelling**

In attributional modelling the life cycle of the system is modelled as it is, following a general supply-chain logic (plus use and end-of-life treatment in case of a product, if these are to be included). The principle system boundaries and included life cycle stages can be derived from the goal and scope of the work. The specific processes are developed stepwise starting from the foreground system and following the process-chain and supply-chain as well as use-stage stepwise upstream and downstream (details see chapter 7.2.3).

In consequential modelling, in contrast, the consequences that the decisions on the foreground system's processes of the analysed system exerts on its background system and/or other systems are modelled. In consequence, processes of other systems than the one analysed are to be included in the system boundary of the analysed system. The system boundaries of an identical product can differ hence strongly between these two approaches. Exceptions are only the processes under direct control of the producer/operator.

### **System boundary diagram**

The system boundary shall be represented in a semi-schematic diagram that explicitly shows which parts and life cycle stages of the system are initially intended to be included and excluded.

Note that in case of partly terminated systems, selected processes are deliberately foreseen to be excluded from the system boundary. The corresponding product and/or waste



flows are meant to stay in the final inventory after aggregation, i.e. cross the system boundary in the provided data set<sup>76</sup>. This shall be shown in the system boundary diagram.

This initial diagram is to be adjusted in case goal and scope need to be adjusted in the course of the project.

A schematic recommended system boundary diagram template is provided as Figure 35 in the annex.

It is recommended to prepare a technical flow chart for the foreground system. This flow chart should show the main process steps (see example in Figure 14). It can later be refined when carrying out the data collection.

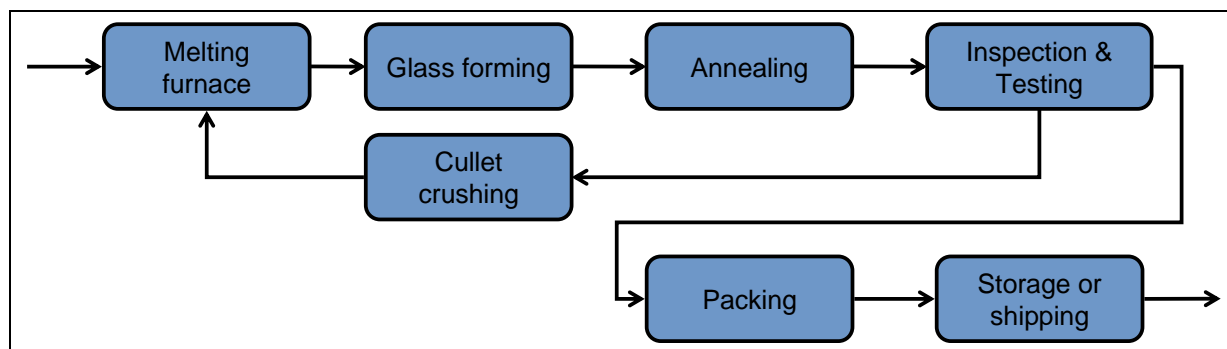

**Figure 14** Flow chart of the foreground system. Illustrate example of a form glass gate-to-gate process chain. In order to have general overview, only the main processing steps are shown; this does not imply data for other activities would be excluded.

### Part-system relationships

LCI or LCA studies on parts or even complex products that are part of a more complex system (e.g. different car starter battery technologies; use of a water-saving shower head; different window frame concepts/materials) need special attention: the technical interaction between the analysed part and the system and its other parts is to be explicitly considered in the system boundary definition. Parts that are operating in context of a larger system can typically not be analysed in isolation, especially not be compared with other parts that interact with the system in another way.

This applies to both attributional and consequential modelling. The related box in chapter 7.2.2 provides more information on this issue.

### System-system relationships

Similar as for part-system relationships also studies on systems that change the operation of other context systems (e.g. computers or coffee-machines that generate heat and change the operation of the heating and/or cooling system of the building in which they are operated) need to consider this interrelationship.

The topic system-system relationship applies to both attributional and consequential modelling. The related box in chapter 7.2.2 provides more information.

### Systematic exclusion of activity types

A systematic exclusion of e.g. transport, infrastructure, services, administration activities, etc. is not appropriate unless necessary according to the specific goal of the LCI/LCA study (e.g. if the quantitative relevance of such activity types is to be analysed, the system would

<sup>76</sup> When later using the data set in another system, the system model has to be completed also for these product and waste flows, of course.

be modelled twice, once with and once without them): in principle all quantitatively relevant activities that can be attributed to a system (or are result of the consequences, in case of consequential modelling) should be included in the system boundaries unless they are quantitatively irrelevant, applying the cut-off criteria (see next subchapter). The need for inclusion and the possibility of exclusion of activities can only be decided for the given case in view of the required completeness and precision of the results. Types of activities that are generally to be included cover for example mining, processing, manufacturing, use, repair and maintenance, transport, waste treatment and other purchased services such as e.g. cleaning and legal services, marketing, production and decommissioning of capital goods, operation of premises such as retail, storage, administration offices, etc. An initial exclusion of activities can be justified, carefully and individually based on experience gained for comparable systems. Reduced accuracy and limitations for conclusions and recommendations are otherwise the consequence.

A systematic approach for identifying activities and processes that are to be attributed to a system is given in the LCI work chapter – see chapter 7.2.3 for attributional modelling and chapter 7.2.4 for consequential modelling

### **Emission off-setting**

Off-set emissions (e.g. due to carbon off-setting by the Clean Development Mechanism, carbon credits, and other system-external off-sets) are not to be included in the system boundaries and the related (reduced) emissions are not to be integrated into the inventory or used in LCA results interpretation. Note that e.g. carbon capture and storage and other means that are part of the analysed systems are to be included; these must not be confused with off-setting measures that are always external to the analysed system.

Such information can only be reported as additional environmental information as may be foreseen e.g. in Environmental Product Declarations (EPD).

## **6.6.3 Quantitative definition of system boundaries – the cut-off criteria**

(Refers to ISO 14044:2006 chapter 4.2.3.3.3)

### **Cutting off data vs. using data estimates**

In general, all processes and flows that are attributable to the analysed system (or affected via consequences, in case of consequential modelling) are to be included in the system boundaries. However, not all these processes and elementary flows are quantitatively relevant: for the less relevant ones, data of lower quality ("data estimates") can be used, limiting the effort for collecting or obtaining high quality data for those parts. Among these, the irrelevant ones can be entirely cut-off (and the effort that would otherwise be needed to collect the data can be used to focus on obtaining better data for the relevant processes and elementary flows).

#### **Terms and concepts: Cut-off criteria**

"Cut-off" refers to the omission of not relevant life cycle stages, activity types (e.g. investment goods, storage, ...), specific processes and products (e.g. re-granulating of internally recycled polymer production waste before re-melting) and elementary flows from the system model.

Cut-offs are quantified in relation to the percentage of environmental impacts that is approximated to be excluded via the cut-off (e.g. "95 %" relates to cutting off about 5 % of the total environmental impact (or of a selected impact category)). Obviously does it a require

an approximation to know what is the 100 % impact, because if one would know the total impact exactly, there would be no need for a cut-off. But the total inventory is always unknown for all life cycle approaches - the 100 % always need more or less approximation and extrapolation from the measured or calculated data.

Important is that the part that is cut-off is not too big, as this has firstly the effect of having incomplete data (i.e. lower environmental impacts) that limits the suitability of the results for comparisons. Secondly does a bigger gap of off-cut processes, flows etc. also lead to higher overall uncertainty: the quantitative estimate of the % impact that is cut-off is more and more imprecise, the more is cut off. More details on cut-offs are provided in this chapter.

Important is also that the cut-off is determined systematically, to avoid inappropriately cutting off relevant parts.

### **Relationship between significance of results and cut-off criteria**

The quantitative definition of the system boundaries concerns the permissible omission of whole life cycle stages, activity types, specific processes and products, and elementary flows. Such omissions ("cut-offs") can however only be justified if they are insignificant to the outcome of the LCI/LCA study. Otherwise they have to be considered in the interpretation phase. For LCI data sets, the cut-off is one of the data quality criteria (see chapter 12) that shall be documented.

The meaning of the above "insignificant" is to be derived through the formulation of quantitative cut-off criteria. These define the minimum required completeness of the data in view of its maximum permissible uncertainty, lack of accuracy and inconsistency in view of the intended application of the results. Note that the various data quality components always interrelate (e.g. can the completeness of 90 % be achieved with "high quality" data, or with a lower quality "data estimate"; see annex Table 6 for the data quality levels). The use of data estimate data again would make the approximation of the 100 % as reference less precise, and so on. It is also to be noted, that the data quality components interact in a multiplicative way and that typically the weakest of the data quality components lowers the overall data quality to its level or below. When defining e.g. cut-off criteria, this is hence to be done both in view of the required minimum quality along the goal and scope of the study and in view of the achieved quality for the other data quality components.

An example: In a comparative assertion study of two product systems it may be found during the iterative analysis that the environmental impact of the two alternatives differs very clearly and always in favour of the same product system (say: about between 60 and 90 % of difference for the individual midpoint level impact categories). The available data might be of high to very high accuracy and precision as most key processes are in the foreground system and measured annual data is available. The minimum required final completeness of the life cycle system data of the two product alternatives could hence be identified to be e.g. 80 %<sup>77</sup>, as this might still allow demonstrating that the two alternatives differ significantly. I.e. the quantitative cut-off would be set to "80 % minimum completeness", i.e. a rather low degree of completeness.

For LCI data sets that are application-unspecific (e.g. average data for background use in decision-context studies under Situation A), in principle the cut-off can be set freely, while the

---

<sup>77</sup> The above "X %" can be derived only iterative after initial system modelling, of course. The use of stochastic methods would help to determine the exact minimum required degree of completeness cut-off %. This would need to also consider data accuracy and precision as all influence the overall significance of differences.

exact cut-off set is to be documented to allow data users to evaluate the suitability of the data for their specific LCI/LCA study.

### **Defining quantitative cut-off criteria / completeness of data**

Valid cut-off criteria are to be defined based on the quantitative degree of completeness of the overall environmental impacts of the product system (e.g. “covering 85 % of the overall environmental impacts”). Two approaches are feasible:

- relating the cut-off to each and any of the to-be-included impact categories (i.e. “85 % of Climate change potential AND 85 % of Acidification potential AND 85 % of Eutrophication potential AND etc.”) This requires that the LCIA methods have been identified at that point; see chapter 6.7.
- relating the cut-off to the normalised and weighted overall environmental impact (i.e. 85 % of the normalised and weighted overall environmental impact). This requires the identification and use of the normalisation basis and the weighting set, see chapter 6.7.6.

The advantage of using the first named approach is that one can work without normalisation and weighting data. The advantage of the second approach is that the effort can be focussed on the most relevant impact categories, while in the first name case also data needs to be collected that is of very little relevance, i.e. for impact categories that have little relevance for the analysed process or system.

Note that in case of Carbon footprints and other studies that apply a limited set of impact indicators, the cut-off will relate to the considered indicators only (e.g. “covering 90 % of the Climate change impacts”).

An example for the definition of the criteria in a specific study or data set is: “The cut-off criteria is the overall environmental impact of the analysed product system given by its normalised and weighted LCIA results, applying the XY LCIA methods, the XY normalisation basis, and the XY weighting set<sup>78</sup>. The study (or data set) covers the processes and flows that contribute at least 95 % of this impact.” The percentage (here e.g. “95 %”) is to be derived for the given case from the goal and scope of the LCA study (or is directly set in the goal definition for background LCI data sets), as discussed before.

### **Preceding remark on applying cut-off criteria in practice**

The application of cut-off criteria has to consider two main aspects: the translation of the cut-off criteria into operational criteria during data collection of the individual unit-processes and - before that - the procedural issue of how to overcome an apparent paradox:

The apparent paradox is that one must know the final result of the LCA (so one can show that the omission of a certain process is insignificant for the overall results) to be able to know which processes, elementary flows etc. can be left out. This paradox is solved through the iterative approach used when performing an LCA, as described in chapter 4 and with more details on the inventory part in Figure 5: the initial settings are to be revisited once or several times and refined in view of the outcome of the subsequent LCI data collection, modelling (including of alternative scenarios), LCIA results calculation, and interpretation (especially contribution, sensitivity, completeness checks and uncertainty analysis). These

---

<sup>78</sup> Until ILCD recommended LCIA methods, normalisation data and weighting sets are available, other internationally accepted and widely used sources are to be applied for LCA studies and hence also for defining and applying the cut-off criteria. Especially when developing and publishing LCI data sets for background use it is recommended to apply more than one combination of LCIA method, normalisation, and weighting and document the respective coverages.

iterative steps are to be repeated until the results meet the completeness, accuracy and precision requirements as needed for the intended applications of the LCI/LCA study.

Details on the application of cut-off criteria in data collection and modelling are given in chapter 7.4.2.11 and 9.3.2.

### Provisions: 6.6 Deriving system boundaries and cut-off criteria (completeness)

Differentiated applicability to Situation A, B, and C.

Differentiated for attributional and consequential modelling.

Note that these provisions will be applied only in the LCI phase.

- I) **SHALL - Scope of LCA:** The following shall be covered by the LCI or LCA study (6.6.1):
  - I.a) potential impacts on the three areas of protection Human health, Natural environment, and Natural resources,
  - I.b) that are caused by interventions between Technosphere and Ecosphere, and this
  - I.c) during normal and abnormal operation, but excluding accidents, spills, and similar<sup>79</sup>.
  - I.d) Other kinds of impacts outside the scope of LCA that are found relevant for the analysed or compared system(s) may be identified and their relevance be justified. [ISO+]
- II) **SHALL - Processes within the system boundary:** The final system boundary/ies of the analysed system(s) shall as far as possible include all relevant life cycle stages and processes that
  - II.a) are operated within the technosphere, and
  - II.b) that need to be included along the provisions of identifying to-be-included processes under attributional or consequential modelling (see chapters 7.2.3 and 7.2.4, respectively), but with the specific provisions and simplifications for the applicable Situation A, B, or C (details see chapter 6.5.4).
  - II.c) Any relevant deviation / omission from the above shall be clearly documented and in case of LCA studies later be considered in the interpretation. (6.6.1)
- III) **SHALL - Flows across the system boundary:** Next to the reference flow(s) that provide the functional unit(s) and permissible waste flows (see 7.4.4.2), no relevant other flows shall cross the boundary between the analysed system(s) and the rest of the technosphere, as far as possible. Only elementary flows (including permissible measurement indicators and flow groups, see 7.4.3.2) should cross the boundary between the analysed system(s) and the ecosphere. Any relevant deviation / omission from the above shall be reported and in case of LCA studies later be considered in the interpretation (6.6.1). [ISO!]

Note: see also chapter 7.4.4 with special provisions for specific types of processes.

<sup>79</sup> I.e. excluding accidents, indoor and workplace exposure, as well as impacts related to direct application or ingestion of products to humans (see text and footnote in chapter 6.6.1).

## Provisions: 6.6 Deriving system boundaries and cut-off criteria (completeness)

- IV) **SHALL - System boundary diagram:** The extent of the system model shall be identified and a schematic system boundary diagram be prepared<sup>80, 81</sup>. Next to the included life cycle stages, the following shall be provided for the different types of deliverables (6.6.2): [ISO!]
- IV.a) **For single operation unit processes:** the process step to be represented.
  - IV.b) **For black box unit processes:** the to-be-represented e.g. process-chain, plant, site, etc. and the first and last process step included.
  - IV.c) **For LCI results, LCIA results and non-comparative LCA studies:** the included life cycle stages. Finally, the first and/or last process step included shall be given, unless the life cycle starts or ends with the cradle or grave, respectively.
  - IV.d) **For comparative LCA studies:** for each of the compared options the included life cycle stages. In addition, for each of the options the first and/or last process steps included shall be given, unless the respective life cycle starts or ends with the cradle or grave, respectively.
  - IV.e) **Flow chart:** Especially for the foreground system, it is recommended to already prepare technical flow charts on the main process steps.
- V) **SHALL - List of exclusions:** Prepare an initial list of any types of activities, specific processes, product and waste flows, elementary flows or other parts that would be foreseen to be excluded from the analysed system, if any (6.6.2). [ISO+]
- Note that this initial list is to be (iteratively) updated to reflect the situation at the end of the study.
- Note that any final exclusion will need to be justified referring to the cut-off criteria and may limit the applicability of the resulting data set or the conclusions that can be drawn from a comparative study.
- VI) **SHALL - Part-system and system-system relationships:** For studies on parts that have a part-system relationship and on systems that have a system-system relationship, obtain data on the effects on the related systems and their data, as far as this is necessary in line with the goal and scope of the study (6.6.2). The related boxes in chapter 7.2.2 provide more information on this issue. [ISO!]
- VII) **SHALL - System-external off-setting:** Off-set emissions (e.g. due to carbon off-setting by the Clean Development Mechanism, system-external carbon credits), and other, similar measures outside the analysed system shall not be included in the system boundaries, as far as they are relevant for the results. The related (reduced) emissions shall not be integrated into the inventory or used in LCA results interpretation (6.6.2). [ISO+]

<sup>80</sup> The recommended formal system boundary template is found in Figure 35.

<sup>81</sup> Other systems that become part of the analysed system in case system expansion is applied should not be shown in this diagram, but the quantitatively most relevant cases of multifunctional processes (as identified in the sensitivity analysis) shall be listed. This includes the quantitatively relevant cases of part-system relationships, which only exceptionally require an expanded system boundary diagram (e.g. if the analysed product would be the "part" of a part-system relationship such shall be provided).

## Provisions: 6.6 Deriving system boundaries and cut-off criteria (completeness)

VIII) **SHALL - Quantitative cut-off criteria:** Define the cut-off % value to be applied for the analysed system's product, waste and elementary flows that cross the system boundary, but that are not quantitatively<sup>82</sup> included in the inventory<sup>83</sup>, as follows (6.6.3):

VIII.a) **Overall environmental impact:** The cut-off % value shall generally relate to the quantitative degree of coverage of the approximated overall environmental impact of the system<sup>84</sup>. For comparative studies the cut-off shall additionally also always relate to mass and energy. Two alternative options exist how to address the overall environmental impact: [ISO!]

VIII.a.i) a) apply the cut-off individually for each of the to-be-included<sup>85</sup> impact categories. This requires that the LCIA methods have been identified at that point; see chapter 6.7.7.

VIII.a.ii) b) apply the cut-off for the normalised and weighted overall environmental impact. This requires that the LCIA methods, normalisation basis and the weighting set have been identified at that point; see chapter 6.7.7.

VIII.b) **Identify the aimed-at % cut-off:** The aimed at quantitative cut-off / completeness percentage shall be identified as follows:

VIII.b.i) **For unit processes, LCI results and LCIA results:** the cut-off value has either already been defined in the goal phase (e.g. "Development of a single operation unit process data set of 95 % completeness") or is to be derived from the respective completeness need of the intended application in the iterative scope steps.

VIII.b.ii) **For non-comparative LCA studies:** the cut-off value has been identified depending on the detail of interest when analysing the system for key contributing processes and elementary flows; this has been defined typically in the goal of the study.

VIII.b.iii) **For comparative LCA studies:** the cut-off value is set depending on how much precision, accuracy and completeness is needed to show significant differences between the compared systems. This is done in the iterations of the LCA work after at least an initial LCI model has been modelled and analysed.

Note that, unless it was initially defined, the cut-off can only roughly be approximated in the initial scope phase and has to be adjusted iteratively.

Note that later deviations from the initially set cut-off criteria, e.g. due to lack of data (see chapter 7.4.2.11.3

<sup>82</sup> The respective flows shall however be foreseen to be identified and stay in the inventory, but without stating an amount and being marked as "missing relevant" or "missing irrelevant", as applicable. Details see Life Cycle Inventory chapter.

<sup>83</sup> Note that co-functions are initially part of the inventory and only later removed via allocation or addressed with system expansion/substitution.

<sup>84</sup> While the true absolute overall impact (i.e. the "100% completeness") cannot be known in LCA and other such models, it can be approximated in practice in an iterative manner and with sufficient precision to serve as practical guidance and use for cut-off. Guidance of applying cut-off in practice see 9.3.2.

<sup>85</sup> For studies with limited impact coverage (e.g. Carbon footprint), only these categories are to be considered, accordingly.

## Provisions: 6.6 Deriving system boundaries and cut-off criteria (completeness)

on dealing with missing data), are to be identified in the subsequent LCI data collection and modelling and are to be documented at the end of the LCI/LCA study. The finally achieved cut-off (and any possible deviations) shall be reported and have to be fully reflected in the interpretation phase, in case of an LCA study. Both may lead to a revision of the supported intended applications of the LCI/LCA study. These issues are to be checked in the respective phase of the LCA work.

## 6.7 Preparing the basis for the impact assessment

(Refers to ISO 14044:2006 chapters 4.2.3.4, 4.4.2.2, and 4.4.5)

### 6.7.1 Introduction and overview

Life Cycle Impact Assessment serves to aggregate the inventory data in support of interpretation. Optionally, normalisation and weighting may be applied to further support this. See also Figure 15.

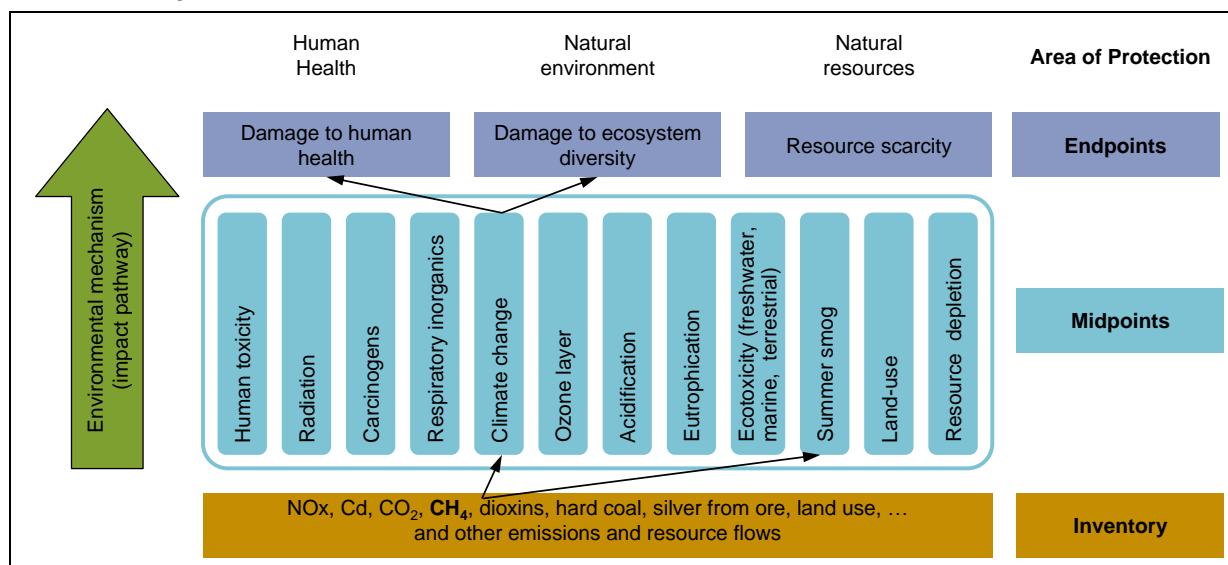

**Figure 15** Life cycle impact assessment. Schematic steps from inventory to category endpoints. Note that normalisation and weighting are not shown and can start from either midpoints or endpoints.

At the same time impact assessment (and optionally normalisation and weighing) are also required for applying cut-off rules to assess data completeness, i.e. for all LCA/LCI studies. They are hence required if the deliverable of the study is an LCI data set.

The environmental impact categories that are to be covered in the life cycle impact assessment (chapter 8<sup>86</sup>) as well as the to-be-applied LCIA methods and the normalisation and weighting sets (if included) shall be determined prior to the initial inventory analysis, as far as feasible. This is to ensure that their selection is not done interest-driven in view of the initial results. This also ensures that relevant and matching inventory data is collected for the

<sup>86</sup> As the selection of LCIA methods is understood to be a scoping issue from the perspective of performing LCA studies, all related steps are joined in this scope chapter. The later LCIA chapter is exclusively applying them, calculating LCIA results. The development of LCIA methods and factors is outside ISO 14044 and outside this document and supported by a separate document "Framework and Requirements for Environmental Impact Assessment Methods, Models and Indicators for Life Cycle Assessment (LCA)".



processes in the system, respectively that appropriate third-party background LCI data sets can be identified.

The selection of impact categories and normalisation and weighting sets shall be consistent with the goal of the LCI/LCA study. An analysis based on the LCI alone without an impact assessment may in some cases be justified depending on the goal of a LCI/LCA study, but it should be noted that this procedure can limit a valid interpretability of results and comparisons. Comparative assertions based on LCI results alone are not permissible under ISO 14044:2006.

The selection of impact categories must be comprehensive in the sense that they cover all relevant environmental issues related to the analysed system (e.g. product). This is unless in the goal definition a limitation was set as e.g. in case of Carbon footprint studies, where exclusively Climate change relevant interventions are considered. The initial exclusion of relevant impacts shall be clearly documented and considered in the interpretation of the results, potentially limiting conclusions and recommendations of the study.

The use of a globally common LCIA methodology and models with global default characterisation factors and – as far as being available and necessary – with non-generic (e.g. differentiated in location or time) characterisation factors would substantially improve comparability of LCA on a global basis. However, as such is not yet available and widely agreed, this guidance has to be operational without such. The following subchapters give the provisions on how to prepare the basis for a correct impact assessment that will then be carried out after life cycle inventory data collection and modelling.

## 6.7.2 Identifying LCIA methods to be applied

(Refers to ISO 14044:2006 chapters 4.2.3.4, 4.4.2.2, and 4.4.5)

### Midpoint and endpoint level impact assessment - requirements

LCIA methods exist for midpoint and for endpoint level, and for both in integrated LCIA methodologies (see Figure 15). Both levels have advantages and disadvantages, which are discussed in more detail in the separate guidance document “Framework and requirements for Life Cycle Impact Assessment (LCIA) models and indicators”. Also the concepts of midpoint and endpoint are detailed in that document. In general, on midpoint level a higher number of impact categories is differentiated (typically around 10) and the results are more accurate and precise compared to the three Areas of Protection at endpoint level that are commonly used for endpoint assessments.

The following impact categories at midpoint level and Areas of Protection shall be checked per default for relevance for the study and related LCIA methods are to be identified that will be used in the life cycle impact assessment phase of the LCA:

- Impact category:
  - Climate change, (Stratospheric) Ozone depletion, Human toxicity, Respiratory inorganics, Ionizing radiation, (Ground-level) Photochemical ozone formation, Acidification (land and water), Eutrophication (land and water), Ecotoxicity, Land use, Resource depletion (minerals, fossil and renewable energy resources, water).
- Areas of Protection:
  - Human health, Natural environment, Natural resources

By default all the above impact categories should be covered by the combination of selected LCIA methods. If available and eligible (see below), it is recommended to use them together with coherent impact factors on the endpoint level.

The selection or development of any LCIA methods shall meet the following requirements, in line with ISO 14044:2006 (details are addressed as part of the separate guidance on “Framework and requirements for Life Cycle Impact Assessment (LCIA) models and indicators”):

- The impact categories, category indicators and characterisation models should enjoy international acceptance. LCIA methods that are endorsed by a governmental body of the relevant region where the decision is to be supported (Situation A, B) or where the reference of the accounted system is located (Situation C), if available. The ILCD System is preparing recommendations regarding impact categories, models, methods as well as related characterisation factors for the reference elementary flows. These may be the basis for such endorsements.
- The category indicators shall include those that are relevant for the specific LCI/LCA study performed, as far as possible. Any gaps shall be documented, and be explicitly discussed in the results interpretation;
- The characterisation model for each category indicator shall be scientifically and technically valid, and based upon a distinct identifiable environmental mechanism or reproducible empirical observation;
- The entirety of characterisation factors should have no relevant gaps in coverage of the impact category they relate to, as far as possible; relevant gaps shall be approximated, reported and explicitly be considered in the results interpretation,
- The category indicators - if endpoint level LCIA methods are included - are to represent the aggregated impacts of the related inputs and outputs of the system on the category endpoint(s);
- Double counting should be avoided across included characterisation factors, as far as possible, and unless otherwise required by the goal of the study (e.g. as covering impacts of the same elementary flows to more than one impact categories with alternative impact pathways of the elementary flow);
- Value-choices and assumptions made during the selection of impact categories and LCIA methods should be minimized and shall be documented as part of the LCIA method data set documentation and preferably of a more extensive report;

An ILCD-compliant LCIA review may be required for eligible LCIA methods. This is addressed in chapter 11 and the separate ILCD review guidance documents.

LCIA methods for further impact categories can be integrated into the analysis (see chapter 6.7.4). This may be required for missing impact categories of specific relevance for the LCI/LCA study and to impact factors for study-specific, impact-relevant elementary flows that are not covered in the applied LCIA method. Also non-generic, i.e. spatially or otherwise differentiated LCIA methods may be required; see chapter 6.7.5.

Depending on the specific system, initial knowledge based on experience gained from detailed and complete studies for sufficiently similar systems or later analysis may show that one or more of the default impact categories are of little overall relevance. Applying the cut-off rules, these impacts can hence be excluded in the further steps, but such an omission shall be quantitatively justified as being insignificant for the overall environmental impact in view of the goal definition and especially the intended applications as well as the cut-off defined for the LCI/LCA study. Note that any relevant exclusion later needs to be explicitly considered during interpretation and can lead to limitations for conclusions and recommendations.

## 6.7.3 Carbon footprint and other selected indicators

(No separate corresponding ISO 14044:2006 chapter but relates to chapters 4.2.3.4 and 4.4.2.2)

Depending on the intended application, it may already initially be foreseen during the goal definition to operate with a limited selection of environmental impact categories (e.g. “Climate change” in Carbon footprint studies or “Energy resource depletion” in Primary energy consumption oriented life cycle studies).

If this is the case, this shall be highlighted and justified in the goal and scope definition. The specific LCIA methods (e.g. using the most recent Intergovernmental Panel on Climate Change (IPCC) factors that are typically used for Carbon footprint studies) shall be identified here.

Exclusion of relevant impact is to be highlighted in the documentation of LCI studies/data sets and LCA studies, including the effect of limited comparability of the results with other systems.

## 6.7.4 Inclusion of non-standard impacts and of non-standard elementary flows

(No separate corresponding ISO 14044:2006 chapter but relates to chapters 4.2.3.4 and 4.4.2.2)

### **Additional impact categories**

Depending on the goal of the LCI/LCA study and the nature of the system, additional relevant environmental issues may need to be addressed. In line with ISO 14044:2006, this inclusion shall be done for missing impact categories of special relevance for the LCI/LCA study.

If this is the case, such additional LCIA methods shall be included in the set or may even - in rare cases - have to be developed. In other cases, existing LCIA methods may have to be extended with characterisation factors for not yet covered elementary flows that are of special relevance for the analysed system. If this is the case, this need shall be identified as part of the scope definition, in order to identify the required information on elementary flows prior to the inventory analysis.

Note that this may be possible only based on insights gained after the first or second iteration of the LCI data collection, modelling, impact assessment and interpretation.

Note that any additional impact category, LCIA method and impact factor has to fulfil the same conditions as the ones listed here in context of the default impact categories in chapter 6.7.2.

### **Additional impact factors**

It may similarly be found that for the selected LCIA method a characterisation factor is missing for an elementary flow in the inventory, which is known to contribute significantly to the respective impact category or category endpoint. This will typically be identified only based on insights gained after the first or second iteration of the LCI data collection, modelling, impact assessment and interpretation.

The necessity to derive / develop such a specific factor for that flow should be evaluated applying the following steps:

- The potential importance of the missing characterisation factor should be evaluated by assuming a conservative value or realistic worst case value e.g. based on chemical, physical, and/or other similarity to other elementary flows which contribute to the same impact category in question. An example might be a missing "Acidification potential"

factor for emissions to air of Acetic acid as a weak organic acid. Based on the similarity in terms of fate and exposure with Formic acid (as derived from its chemical, photo-chemical and physico-chemical characteristics such as e.g. water-solubility) a stoichiometrically adjusted factor can be assigned. Similarly, can the Eutrophication potential of an emission to fresh water of urea as a quickly biodegrading nitrogen-containing organic compound be approximated by that of nitrate to water, after stoichiometric conversion of the N-content in the urea.

- This assumed characterisation factor should be applied to the elementary flow and be investigated whether the total result for the impact category is changed to a relevant degree (i.e. depending on the required accuracy, especially the completeness requirements / cut-off rules, as derived from the goal of the study).
- If the contribution from the elementary flow cannot on this basis be classified as insignificant, it should be attempted to get a more accurate and precise value for the missing characterisation factor. Note that this factor will have to fulfil the same conditions as other factors of the respective LCIA methods.
- If this is not possible, the fact of the missing characterisation factor must be reported and the potential influence of the missing factor must be considered in the interpretation of the results.
- If in contrast the conservative / worst case assumption does not lead to a significant contribution from the elementary flow, the missing characterisation factor can be disregarded. It is recommended to report the fact of a "missing factor" nevertheless, at least for those flows that lack relevance but are not fully irrelevant.

Note that this procedure requires expert knowledge of an LCIA method developer, especially fate and exposure modelling, and a good chemical and environmental sciences understanding.

Also refer to the document "Requirements for Environmental Impact Assessment Methods, Models and Indicators for LCA".

## 6.7.5 Spatial and other differentiation / modification of impact factors

(No separate corresponding ISO 14044:2006 chapter but relates to chapters 4.2.3.4 and 4.4.2.2)

ISO 14044:2006 foresees that "*Depending on the environmental mechanism and the goal and scope, spatial and temporal differentiation of the characterization model relating the LCI results to the category indicator should be considered.*" Given however the lack of spatially or temporally differentiated LCI data and especially corresponding LCIA methods, for the time being such differentiation is in practice not or rarely feasible.

If aimed at, the use of such non-generic (e.g. spatially or otherwise differentiated) LCIA methods shall be scientifically justified in so far, that it results in significantly different LCIA results. Note that independently of this, an ILCD-compliant LCIA review may be required for any applied LCIA methods. This is addressed in chapter 11 and the separate guidance document on "Review schemes for Life Cycle Assessment (LCA)".

Note that, in case non-generic impact assessment is applied, the characterisation step will have to be done on the not aggregated inventory result. After the characterisation step, the LCIA results may be summed up per impact category and can be provided together with the corresponding aggregated LCI results. If such is done, the LCIA results obtained applying non-generic LCIA methods shall be provided in the report in addition to the differentiated ones.

Note that this step is often only possible after the first or second iteration of LCI data collection and modelling.

Note that for comparative LCA studies also the appropriateness of the generic LCIA methods shall be discussed in the interpretation phase of the study. If a further, especially spatial or temporal differentiation can be argued to lead to substantially different results, this finding may limit the conclusions and recommendations that can be drawn from the study.

Note that LCIA results calculated from non-generic LCIA methods are later to be presented and discussed additionally separately from the default, generic ones.

## 6.7.6 Selection of normalisation basis and weighting set<sup>87</sup>

(No separate corresponding ISO 14044:2006 chapter but relates to aspect "environmental significance" of chapter 4.2.3.4 and to chapter 4.4.3)

### Introduction

Normalisation and weighting are optional steps under ISO 14044:2006 to support the interpretation of the impact profile and are steps towards a fully aggregated result. Note that normalisation and weighting may also be used to define the quantitative cut-off rules (see chapter 6.6.3) and to check the achieved degree of completeness of the data set inventory. This means they may be required independently of the type of deliverable of the LCI/LCA study.

Note that not all endpoint level based weighting methods require a normalisation step: those that express the potential damages to the included Areas of protection in a common unit (e.g. monetary methods) operate without an explicit normalisation. In that case the normalisation is implicitly included in the endpoint modelling step. For such methods the use of an additional normalisation step would hence be wrong. For those weighting methods, in contrast, that require a preceding normalisation, a weighting without normalisation would provide wrong results.

### Frequent errors: Incompatible LCIA methods, normalisation basis, and weighting set

It is important to be aware that the chosen LCIA methods, the normalisation basis and the weighting set have to be carefully chosen including that they fit together. I.e. they need to relate to exactly the same midpoint level or endpoint level categories. Sometimes only partly or not at all compatible data are combined. This leads to distorted or meaningless results. Also a correct relation of the geographical reference is important to ensure the appropriate decision support.

Note: As the development of normalisation and weighting factors is not part of the ILCD System work, these topics are not discussed in detail, but basic guidance along the ISO provisions on their selection is given here below and on their use (see chapters 8.3 and 8.4).

### Normalisation basis - requirements

In normalisation, the indicator results for the different midpoint level impact categories or endpoint level damages are expressed relative to a common reference, by dividing the indicator results by the respective reference value. As reference values typically the impact

---

<sup>87</sup> "Grouping" is not addressed in this guidance document as not seen as adding practical value in context of decision support. If it is planned to include a grouping step in an LCA study, please refer to the ISO 14044 provisions.

or damage results of the total annual territorial elementary flows in a country, region, or continent, or globally (or per average citizen, i.e. per capita) are used<sup>88</sup>. These reference impact or damage results are termed “normalisation basis”. The normalisation basis is calculated from the inventory for each of the impact categories or damages in the same way as the impact indicators or damages of the analysed system (e.g. product) are calculated from its life cycle inventory: For midpoint level results the normalisation basis is the overall potential impact, calculated from the annual inventory of elementary flows. For endpoint level results the normalisation basis is the overall damage to the areas of protection.

To ease communication (and quality checks) across studies, it is recommended to use as normalisation basis the elementary flow inventory per capita<sup>89</sup> in the selected country/region/globally per year.

The decision whether to use global data or data for a specific country, region or continent shall be made during the initial scope definition and shall be justified along the following considerations:

- Where are the supported decisions be made (Situations A, B), or where is the reference of the accounting (Situation C)?
- Relevance for the intended application(s) and target audience of the LCI/LCA study
- Sufficiently complete availability of inventory data for the chosen country, region or globally, and with a sufficiently similar completeness of all impact categories / areas of protection considered in the LCI/LCA study.
- The elementary flows of the normalisation basis have to be appropriate for use with the LCIA method used for the LCI/LCA study, i.e. are classified and characterised as are those of the analysed system.
- Compatibility with the midpoint impact categories or category endpoints, as applied, and with the set of weighting factors to be subsequently applied, if any (see below).

The year of the normalisation basis should be the latest year for which reliable data are available. The chosen normalisation basis should not be changed later on in the study, unless it has to be extended if in the course of the study a non-default impact category has been additionally included.

### Weighting factors - requirements

In weighting, the (typically normalised) indicator results for the different impact categories or damages are each multiplied by a specific weighting factor, that is intended to reflect the relative relevance of the different impact categories / category endpoints among each other. For example the impact category "Acidification potential" may get a weight of e.g. 2 and the impact category of "Photochemical ozone creation potential" a weight of e.g. 3, and so on for all included impact categories.

Weighting sets can be developed by different mechanisms such as setting them by public policy makers or industry panels, broader stakeholder panels, expert panels, and so on.

---

<sup>88</sup> Other time-references than one year can be used but are uncommon.

<sup>89</sup> This is because values for typical products (e.g. 1 kg fresh tomatoes, 1 private house type X, etc.) the normalised LCIA results in this case are in the range of roughly between 10 down to 0.00001 and have a clear meaning. If a whole country is the normalisation basis the values are in the range of  $10^{-7}$  down to  $10^{-14}$  what makes them un-illustrative and also difficult to do quick plausibility checks. Also, the numbers differ considerably depending on the population size of the country (and not only due to the different overall impact of the average citizen of different countries).

They can hence reflect a range of scientific expertise but also political and other value-based considerations. It is to be highlighted that weighting factors are intrinsically always normative/subjective and reflect value assumptions.

The identification of a suitable weighting set shall be done, justified, and documented during the initial scope phase of the study and in line with its goal, especially the intended applications and target audience.

The following considerations are to guide the selection/identification of weighting factors:

- Relate to the normative/cultural/religious or other societal setting globally or of the country or region where the supported decisions are made (Situations A, B), or the reference of the accounting (Situation C).
- Relevance for the intended application(s) and target audience of the LCI/LCA study
- Refer correctly to the specific set of midpoint level impact categories or endpoint level Areas of protection provided by the LCIA method used for the study
- Be regarding chosen country, region or global scope compatible with the set of normalisation factors that were applied, if any.

The chosen weighting set should not be changed later during the study, unless it will require extension if in the course of the study a non-default impact category has been additionally included.

## 6.7.7 Documentation of decision on LCIA methods, impact level, normalisation basis, and weighting factors

(No separate corresponding ISO 14044:2006 chapter but relates to chapters 4.2.3.4 and 4.4.3)

Especially for comparative assertions disclosed to the public, but also for other deliverables that are meant to support product comparisons by third parties (e.g. EPDs), the selection of the finally to-be-applied LCIA methods and the evaluation level (midpoint or endpoint) shall be made during the initial scope definition. Equally shall the decision about the possible (optional) inclusion of a normalisation and weighting step in support of the results interpretation be made during the initial scope definition.

If these decisions would be made or revised after the LCI work has been performed and results have been calculated, this could be interpreted as trying to influence the outcome of the study by selecting the most favourable impact models, impact level, and normalisation/weighting approach and data.

These decisions shall be documented or published in an appropriate form and way that allows the critical reviewer to later verify the date when these have been made. Changes of these decisions shall only be possible:

- if relevant impact categories and factors for individual elementary flows are added in line with the goal of the study. This shall moreover result in an extension of the normalisation basis and weighting set (if included) for the added impact categories and elementary flows.
- if using non-generic (e.g. spatially or otherwise further differentiated) LCIA methods upon justification as indicated more above, or
- excluding impact categories due to lack of relevance for the overall environmental impact (only applicable if referring the cut-off to the normalised and weighted overall LCIA results). This shall be demonstrated by applying the cut-off rules. It results in

the removal of the normalisation value(s) and weighting factor(s) for the affected impact category/ies.

### Provisions: 6.7 Preparing the basis for the impact assessment

Applicable to Situation A, B, and C. Few differences between A/B and C.

Note that an impact assessment is required for all types of LCI/LCA studies at least for systematically assessing and improving the overall data quality, including applying the cut-off rules as described in chapter 6.6.3.

#### Impact categories and LCIA methods:

- I) **SHALL - Goal-conform selection of impact categories and LCIA methods:** Select the impact categories to be included and the corresponding LCIA methods in accordance with the goal of the study. [ISO!]
- II) **SHOULD - Requirements for impact categories:**
  - II.a) All impact categories that are environmentally relevant<sup>90</sup> for the LCI/LCA study shall be included, as far as possible and unless the goal definition would explicitly foresee exclusions (e.g. for Carbon footprint studies). Further ones can be included optionally.

Note that any relevant exclusion will need to be explicitly considered during interpretation and can lead to limitations for the further use of the data (in case of an LCI study or data set) and in limitations for the conclusions and recommendations (in case of an LCA study).
- III) **SHALL - Requirements for LCIA methods:** All included LCIA methods shall meet the following requirements<sup>91</sup> (6.7.2):
  - III.a) They should be internationally accepted and preferably additionally be endorsed by a governmental body of the relevant region where the decision is to be supported (Situation A, B) or where the reference of the accounted system<sup>92</sup> is located (Situation C).
  - III.b) They shall be scientifically and technically valid, as far as possible; the extent of this fact shall be documented.
  - III.c) They shall have no relevant gaps in coverage of the impact category they relate to, as far as possible; otherwise the gap shall be approximated, reported and explicitly be considered in the results interpretation,
  - III.d) They shall be based upon a distinct identifiable environmental mechanism or reproducible empirical observation,

<sup>90</sup> As this can be judged only in view of the LCIA results, i.e. after LCI data collection, modelling, etc., it is recommended to initially foresee the inclusion of all of the default impact categories (see next action). If the impact assessment later shows irrelevance of one of more impact categories they can be left out; see also further provisions. For principally restricted assessments (e.g. Carbon footprint) see the respective action below.

<sup>91</sup> Under the ILCD, recommendations are under preparation on a complete set of such LCIA methods that provide characterisation factors for the ILCD reference elementary flows. These will relate to European and/or global scope, depending on their applicability.

<sup>92</sup> "Reference of the accounted system" refers to e.g. the country or region for which a consumption, production, or territorial indicator is modelled, or to the country in which the company is located that models accounting data for its key products.



## Provisions: 6.7 Preparing the basis for the impact assessment

- III.e) They shall be related exclusively to elementary flows (i.e. interventions between the technosphere and the ecosphere) during normal and abnormal operating conditions, but excluding accidents, spills, and the like. [ISO!]
- III.f) They shall be free of double-counting across included characterisation factors, as far as possible and unless otherwise required by the goal of the study, and
- III.g) They shall be free of value choices and assumptions, as far as possible; these shall be appropriately documented and if relevant they shall explicitly be considered in the results interpretation.

The development or identification of LCIA methods that are prepared to meet these requirements is supported with the separate guidance document "Framework and requirements for Life Cycle Impact Assessment (LCIA) models and indicators".

Note that for use in comparative assertion studies any used LCIA method and factor may need to undergo a review under ISO in order to be eligible.

- IV) **SHOULD - Default impact categories and category endpoints:** The selected LCIA methods in their entirety should by default cover all of the following impact categories and provide characterisation factors on midpoint level. It is recommended that they also provide modelled category endpoint factors that are coherent with the midpoint level and that cover all relevant damages to the three following areas of protection (6.7.2):
  - IV.a) **Impact categories ("midpoint level"):** Climate change, (Stratospheric) Ozone depletion, Human toxicity, Respiratory inorganics, Ionising radiation, (Ground-level) Photochemical ozone formation, Acidification (land and water), Eutrophication (land and water), Ecotoxicity (freshwater, marine, terrestrial), Land use, Resource depletion (of minerals, fossil and renewable energy resources, water, ...). [ISO!]
  - IV.b) **Category endpoints ("endpoint level"):** Damage to human health, Damage to ecosystem, Depletion of natural resources. These relate to the three areas of protection "Human health", "Natural environment", and "Natural resources", respectively. [ISO+]
- V) **SHOULD - Location and time generic LCIA:** The LCIA methods should by default be location-generic and time-generic (but see later provision on derived LCIA methods). [ISO!]
- VI) **MAY - LCIA methodologies:** It is recommended to select available LCIA methodologies that provide a complete set of single LCIA methods, rather than selecting and combining individual LCIA methods. [ISO!]
- VII) **SHOULD - Excluding impact categories?:** Exclusions of any of the above impact categories should be justified as being not relevant for the analysed system(s). This can be done based on experience gained from detailed, complete studies for sufficiently similar systems and/or system group specific / Product Category Rule (PCR) type guidance documents. (6.7.2 and 6.7.3) [ISO+]
- VIII) **SHALL - Adding impact categories?:** Check for the specific LCI/LCA study whether next to the default impact categories given above, additional, relevant environmental

## Provisions: 6.7 Preparing the basis for the impact assessment

impacts<sup>93</sup> need to be included in accordance with the goal and scope. If so, identify or develop<sup>94</sup> the relevant LCIA methods to be applied. Note that these shall meet the same requirements as the other included LCIA methods (see above) (6.7.4).

- IX) **SHOULD - Impacts outside the scope of LCA:** Impacts that are outside the LCA frame<sup>95, 93</sup> but for which scientific evidence exists that they are relevant for the analysed or compared system(s) should be clearly and individually be identified, including in the Summary and Executive summary of the report / data set. Their brief description should be foreseen in the further documentation. If it is foreseen to include them quantitatively, this requires potentially different modelling and analysis approaches and guidance. This should be done jointly with the LCA study, as far as possible, to ensure coherence, but inventory, impact assessment, etc. shall be kept separately for clear interpretation (6.7.4). [ISO!]

Note that this step is often possible only after the first or second iteration of LCI data collection and modelling, impact assessment, and interpretation.

- X) **SHOULD - Missing characterisation factors:** If a characterisation factor is missing for an elementary flow of the analysed inventory, and that flow is known to contribute significantly to one or more of the included impact categories, considering the goal and scope of the LCI/LCA study (6.7.4): [ISO+]

X.a) Check the potential importance of the missing characterisation factor by assuming a conservative value or reasonably worst case value based on chemical, physical, biological and/or other similarity to other elementary flows which contribute to the same impact category/ies in question.

Note that this procedure requires expert knowledge of an LCIA method developer, especially on fate and exposure modelling to be able to judge which similarities to consider and how; a good chemical and environmental sciences understanding is equally required.

X.b) Apply the assumed characterisation factor(s) to that elementary flow and investigate whether the total result for the affected impact category/ies is changed to a relevant degree (i.e. depending on the required completeness, accuracy, and precision).

X.c) If with this approach the contribution from this elementary flow cannot be classified as being not relevant, it should be attempted to get a more accurate and precise value for the missing characterisation factor and use that one for the further work.

Note that this factor will have to fulfil the same conditions as other factors of the respective impact

<sup>93</sup> Examples are Noise, Desiccation / Salination, Littering of land and sea, etc.

<sup>94</sup> ISO 14044 requires that all relevant impacts are to be covered. In practice of performing LCA studies, the development of new LCIA methods is a rare case. The separate guidance document "Development of Life Cycle Impact Assessment (LCIA) models, methods and factors" supports LCIA method developers in this step.

<sup>95</sup> The inventory related to impacts that are outside the frame of LCA shall not be mixed with the for LCA impacts, i.e. need separate inventorying as separate items outside the general Inputs/Outputs inventory. The LCA frame covers potential impacts on the named three areas of protection that are caused by interventions between Technosphere and Ecosphere during normal and abnormal operation. I.e. Accidents, indoor and workplace exposure, as well as impacts related to direct application or ingestion of products to humans shall not be mixed but be modelled and inventoried separately (see also 6.8.2).

## Provisions: 6.7 Preparing the basis for the impact assessment

category / method.

- X.d) If the latter is not possible or the whole provision is not feasible (e.g. for cost or timing reasons), the fact of a missing relevant characterisation factor shall be reported and the potential influence of the missing factor shall be considered when reporting the achieved data quality and (for LCA studies) in the interpretation of the results.
- X.e) If the conservative or reasonably worst case value does not show a relevant contribution from that elementary flow, the missing characterisation factor can be disregarded. It is recommended to report the fact of a "missing factor" nevertheless and marked as "missing unimportant", at least for those flows that lack relevance but are not fully negligible.

Note that this step is often only possible after the first or second iteration of LCI data collection and modelling, impact assessment, and interpretation.

- XI) **SHALL - Location and time non-generic LCIA methods:** The potential use of LCIA methods that have been derived from the original, location-generic and time-generic ones (i.e. being not generic but e.g. spatially or otherwise further differentiated or modified) shall be justified along the goal and scope of the study. It shall be demonstrated that significantly different LCIA results are obtained than with the generic methods. The non-generic methods have to meet the other applicable requirements for selected LCIA methods (6.7.5). [ISO!]

Note that this step is often only possible after the first or second iteration of LCI data collection and modelling, impact assessment, and interpretation.

Note that for comparative LCA studies also the appropriateness of generic LCIA methods shall be discussed in the interpretation phase of the study. If a further differentiation can be argued or approximated to lead to significantly different results, this finding may limit the conclusions and recommendations that can be drawn from the study.

Note that LCIA results calculated from non-generic LCIA methods are later to be presented separately from the generic ones and discussed jointly.

### Normalisation and weighting:

- XII) **SHALL - Cut-off criteria:** Normalisation and weighting may have been used for defining the cut-off rules in chapter 6.6.3 (6.7.6). [ISO!]

- XIII) **MAY - Results interpretation:** Normalisation and weighting are in addition optional steps under ISO 14044:2006 that are recommended to support the results interpretation. (6.7.6)

Note that the normalisation and weighting shall be made in accordance with the intended application of the LCI/LCA study.

Note that if the study includes a comparative assertion to be disclosed to the public, quantitative weighting of the published indicator results is not permitted.

- XIV) **SHALL - Consistency between cut-off and interpretation:** If used in support of results interpretation, the same normalisation and weighting set shall be used as for the cut-off rules (6.7.6). [ISO!]

- XV) **SHALL - Requirements for selecting normalisation basis and weighting set:** If used for defining the cut-off and/or in support of the interpretation of the results of the study,

## Provisions: 6.7 Preparing the basis for the impact assessment

select a suitable normalisation basis and weighting set<sup>96</sup>, along the following rules (6.7.6): [ISO!]

### XV.a) Normalisation basis:

- XV.a.i) As normalisation basis the annual total environmental inventory globally should be preferred. Alternatively the territory-based or consumption-based annual total environmental inventory of the country or region should be used where the supported decisions are made (Situations A, B) or in which the accounting reference is located (Situation C). It is recommended to prefer the average citizen as normalisation basis instead of the global, regional or country total (i.e. the global, regional or country total divided by the number of citizen<sup>97</sup>).
- XV.a.ii) Ensure the relevance of the selected normalisation basis for the intended applications and target audience.
- XV.a.iii) Ensure a high degree of completeness and precision of the overall environmental impact covered and a similar degree of completeness and precision for all covered impact categories.
- XV.a.iv) Ensure a proper link with the used LCIA methods, i.e. relate to the same impact categories / areas of protection and use to a sufficient degree the same elementary flows.
- XV.a.v) Ensure technical compatibility with the to-be-used weighting set, i.e. relate to the same impact categories / areas of protection.
- XV.a.vi) As year for the normalisation basis the year should be used for which the latest data are available that meet the above requirements.

### XV.b) Weighting set:

- XV.b.i) The weighting set should represent the normative and other values globally or of the country or region where the supported decisions are made (Situations A, B), or the reference of the accounting (Situation C). The weighting set should preferably be endorsed by a governmental body of the country or region where the decision is to be supported (Situation A, B) or where the reference of the accounted system is located (Situation C).
- XV.b.ii) Ensure the relevance of the selected weighting set to the intended applications and target audience.
- XV.b.iii) The weighting set shall correctly refer to the used normalisation basis and to the midpoint level or endpoint level indicators of the used LCIA methods, as applied.

XV.c) **Extension for added impact categories:** If in the course of the study a non-default impact category has been additionally included, corresponding data for

<sup>96</sup> The development of governmentally supported corresponding normalisation and weighting data in the different regions and countries or globally would be beneficial.

<sup>97</sup> This brings the values of the normalised impacts for goods and services down to a better communicable and interpretable level (typical value range 10 to 0.00001 instead of 1E-7 to 1E-14).

### Provisions: 6.7 Preparing the basis for the impact assessment

the normalisation basis and a weighting factor shall be additionally provided and used<sup>98</sup>.

#### Documentation of selected LCIA methods, and of decision / selection of normalisation and weighting:

XVI) SHALL - **Verifiable documentation of decision on LCIA methods, impact level, normalisation and weighting:** Decide and document now, during the initial scope definition, bindingly on (6.7.7): [ISO!]

XVI.a) the LCIA methods to be applied by default,

XVI.b) the selected impact level to be used for reporting and interpretation (i.e. midpoint and/or endpoint level), and if foreseen to be used,

XVI.c) the specific normalisation and weighting sets to be used for cut-off and for interpretation.

XVI.d) These decisions shall be documented or published in an appropriate form and way that allows the critical reviewer to later verify the date when these decisions have been made.

XVI.e) **Permissible adjustments:** Adjustments of these decisions shall only be possible (6.6.7):

XVI.e.i) If impact categories are added in line with the goal of the study and meeting the related provisions for their addition given more above. This shall result exclusively in an addition to the already selected LCIA methods, normalisation basis and weighting set for the added impact categories.

XVI.e.ii) If using non-generic LCIA methods upon justification as indicated more above. This shall result exclusively in a differentiation of the already selected, generic LCIA methods, unless a best attainable consensus can be found among involved stakeholders on selection of another set of already available non-generic LCIA methods. The normalisation basis and weighting set shall remain unchanged.

<sup>98</sup> This is not required for use of non-generic LCIA methods and for additionally included single elementary flows / characterisation factors, unless this would relevantly change the results, what by default can be assumed to be not the case.

## 6.8 Representativeness and appropriateness of LCI data

(Refers to aspects of ISO 14040 chapter 4.2.3.6.2)

### 6.8.1 Introduction and overview

(Refers to aspect of ISO 14044:2006 chapter 4.2.3.6.2)

#### Introduction

LCI data quality can be structured by representativeness (composed of technological, geographical, and time-related), completeness (regarding impact category coverage in the inventory), precision / uncertainty (of the collected or modelled inventory data), and methodological appropriateness and consistency. For details and illustrative graphics see annex 12 on data quality aspects and indicators.

Within the concept of “Data quality”, the representativeness of the LCI data is a key component. It is the aim of LCA to reflect the existing physical reality of an existing supply chain (attributional modelling) or the forecasted physical reality of a theoretical future supply chain steered by market mechanisms in consequence of analysed decisions (consequential modelling). This means that the life cycle models are to be in accordance with what actually happens or can be expected to happen, to the extent possible. On a system's level, the inventory data must be representative of the processes, which actually relate to the life cycle of the system (e.g. product).

#### Representativeness and appropriateness

The ability of the inventory data to represent the environmental impacts of a system can be differentiated into two closely related aspects: representativeness and appropriateness<sup>99</sup>. The first aspect, the representativeness, addresses how well the collected inventory data represents the “true” inventory of the process for which they are collected regarding technology, geography and time. E.g. may some of the flow information be taken from similar processes, older data sources, another country, be estimated or missing, etc.; such data lacks representativeness to some degree. The second aspect, the appropriateness refers to the degree to which a process data set that is used in the system model actually represents the true process of the analysed system. E.g. when Danish office paper of 2005 is required as input to an analysed system, a process data set for “Danish newsprint paper of 2006” is fully appropriate regarding geography while limited in technical and somewhat limited in time-related appropriateness.

In system models, the data has to be both sufficiently representative and appropriate. There is hence the representativeness of a unit process data set inventory for the represented process(es) and the appropriateness of a (unit process, LCI result, etc.) data set for a required function / product on the system level. Combined, this results in the overall representativeness of the LCI result inventory for the analysed system.

#### Overview

Representativeness is classically looked at from technological (chapter 6.8.2), geographical (chapter 6.8.3) and time-related perspective (chapter 6.8.4), while these three are closely interrelated.

---

<sup>99</sup> Note that here, same as in common LCA practice, both aspects are also jointly covered by the term “representativeness”.

It depends on the specific case, which aspect is most important: Data with good geographical and technological representativeness can be more appropriate in some instances than using the most recent data (time-related representativeness). This is to be identified for the given case: how different is the process inventory for the different geographical situation and different technology and how fast does it change with the years due to technological progress and changes in the background system? In general, it can be found - same as across all data quality aspects - that the weakest of the appropriateness components determines (i.e. lowers) the overall quality.

Note that in attributional and consequential modelling representativeness refers to different technologies (and sometimes geography), as to be explained.

## 6.8.2 Technological representativeness

(Refers to aspect of ISO 14044:2006 chapter 4.2.3.6.2)

### Technological representativeness of process and product

Technological representativeness relates to two interlinked aspects: the process step (i.e. the activity) and its product (i.e. the result of the activity that represents the functional unit of the process) that are both to be explicitly considered.

#### Terms and concepts: Technological representativeness of process and product

##### Introduction

The technological representativeness of a process or system identifies how well the inventory data represents it regarding its true technological or technical characteristics that are documented in the descriptive information of the data set or report.

##### Aspects of technological representativeness of a process

The specific technology that is used and the way in which it is operated, strongly influences the environmental impacts of the process, as to be expressed in its inventory. This applies to both the inputs (e.g. consumed energy, materials, used services) as well as the outputs (e.g. the process-specific emissions) that can differ considerably among technologies producing the same e.g. product. This is especially the case for highly variable processes. (For the difference between variance and variability - see annex 12.2 under "Variance vs. variability".)

The number of aspects that can for the given case be decisive for the inventory is very extensive: the raw material basis, route of synthesis, the intermediaries used, the nature of the process in terms of enclosure, abatement techniques, etc., the speed of services, the load factor and other parameters of highly variable processes such as waste treatment and transport, internal recovery rates, etc.

##### Aspects of technological representativeness of the product

The specific product that is to be represented by a data set or used in another system as input (e.g. a specific type of steel, a distinct kind of service) can differ in many technological and other aspects, i.e. its specifications. The applicability of the product for a specific purpose (i.e. the appropriateness of its functional unit) differs typically very much among often only seemingly similar products. At the same time the environmental impact can differ hugely (as the case e.g. between technical quality silicon and chip-grade silicon).

It appears not useful to try listing all potentially relevant aspects. All quantitative and qualitative aspects of the functional unit and specification can matter for a given case. Often forgotten in practice are the following with the list by no means being exhaustive: purity of

material (e.g. technical quality silicon vs. chip-grade silicon), processing depths of materials (e.g. metal bar vs. metal foil), specific treatments (e.g. surface treatment, coating, etc.), durability / life time, quality of a service, the actual composition of a material (e.g. a polymer recipe with not only the main resin but also with fillers, colouring agents, stabilisers, curing agents, etc.), the specifically achieved recyclability of a product compared to average recyclability of the contained material(s), etc. Furthermore also the specific process or mix of processes and routes that has produced the product in question (e.g. the product hydrogen either from steam conversion of natural gas, or from geothermal energy, or solar electricity,...). Hence the combined representativeness of product and process(es) needs additional attention.

### Background system data for consequential vs. attributional models

The technological representativeness of the different activities throughout the life cycle of the analysed system is a key feature of a valid LCA. This applies to both attributional and consequential modelling alike. Note however that these two modelling principles may require substantially different processes in the background system that are to be represented by the used LCI data sets:

For attributional modelling, technology-specific data of the supply-chain should be foreseen for the foreground system and average market consumption<sup>100</sup> mix data for the background system. These are ideally the primary data and the secondary data of the suppliers and of the downstream users (e.g. further processors, use stage, recyclers) of the e.g. product, if the system covers the full life cycle.

Secondary data from e.g. third-party database providers, being specific, generic or average data can be used also in parts of the foreground system. This should be done only if for the given case those data is more accurate, precise, and complete. This can be if primary data and suppliers' data is of little completeness or representativeness (e.g. regarding operating conditions). Note that this can be checked only in the subsequent iterative steps of the LCI work, of course.

For consequential modelling, the same data should be foreseen for the foreground system. Here this should include the suppliers' technology-specific data of the contractually fixed or planned supply-chain links to the foreground system. The appropriate short-term or long-term marginal technological mixes (see chapter 7.2.4) should be foreseen to be used for the background system. The named long-term mix only applies to those processes under Situation B that face "big" changes in consequence of the analysed decision, and - optional - for the assumption scenarios. The technology mix of marginal processes shall be foreseen to be identified depending among others on the market direction and the cost-competitiveness of potential marginal processes.

The identification of the short-term and long-term mixes is not straightforward and needs the introduction of the related concepts first. For the detailed provisions, please see chapter 7.2.4.4.

---

<sup>100</sup> That also applies if a market production mix data set is developed (e.g. "PP granulate produced in Germany in 2005": the fact that the data set is to represent the production mix would be achieved by combining the representative mix of producing technologies (and sites) of that market according to their production share. For the data in the background system of the individual routes nevertheless the respective consumption mix data are to be used (e.g. here: crude oil mix consumed in Germany for propylene production).



### Average vs. specific mode of operation, cycle step, etc.

Check along the goal of the study and the intended applications whether the data needs to represent a specific way of operation or aspect of the technology / technique (e.g. a specific load factor for transport, or a specific start, closure etc. cycle step of a process, etc.). This can be if the goal requires deviating from the average, typical or integrated technology / technique operation. This aspect closely relates to the explanations in the "terms and concepts" box above.

### Non-scalable processes / systems in Situation A and B

Where attributional modelling is to be used for the main system model in Situations A and B, a specific provision requires to use consequential aspects regarding the technological representativeness: if the process / system is not scalable (e.g. hydropower production in many countries) the average market mix of technologies (here: for electricity production) is to be used and not the specific supplier / technology (here: for hydropower). This is unless the user of such a not freely scalable process can demonstrate that the production is actually quantitatively increased in consequence of its specific demand, what can also be via import from not limited supply. If such an identified actual increase is only meeting a part of the demand, only that share can be modelled using the specific process data and for the remainder the market mix is to be used.

This is necessary as under these conditions big differences often occur between attributional and consequential processes that at the same time can be systematically and reproducibly avoided by using the market mix instead. Figure 16 illustrates this situation of limited/non scalability.

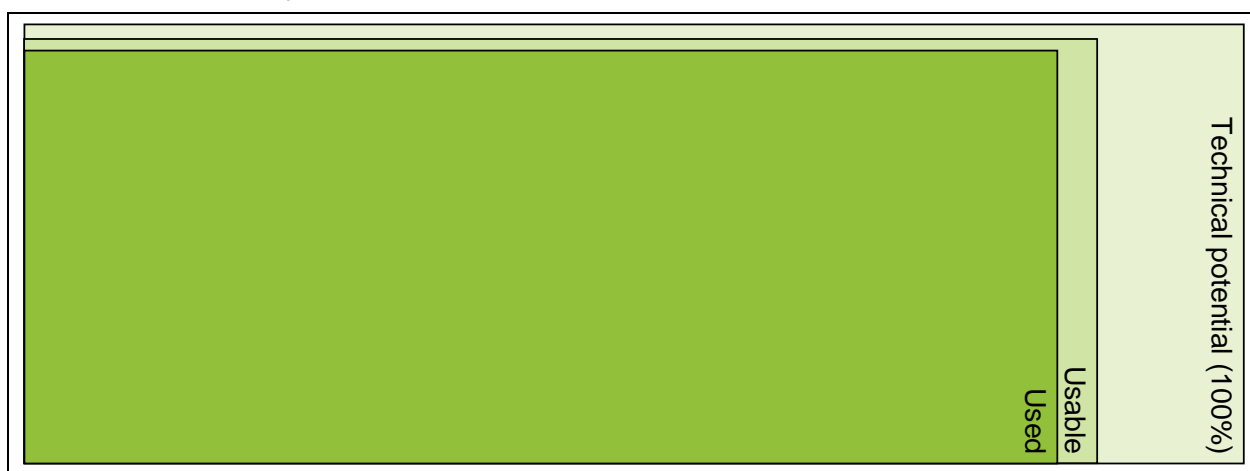

**Figure 16** Limited or non-scalability of supplies in a market. The example of hydropower; illustrative. If the used amount of hydropower is equal or close to the usable amount, an additional demand in hydropower can be assumed to not result in more hydropower being produced; Hydropower is not relevantly up-scalable in that case. The usable amount can be restricted by other than technical factors. Here this might be nature protection or legislative restrictions. If such factors are changed and more strict this can result in an absolute non-scalability, as the used amount would be "frozen" by these other factors or might even be stepwise reduced.

In the example of electricity procurement, a consequential modelling would require the use of the mix of marginal technologies to be used. If – as in the example of hydropower – the specific procured technology hydropower is not scalable in production (as e.g. in Germany), the consequential demand for electricity is not resulting in additional hydropower installed but this is only resulting in a virtual shifting of electrons from the electricity market

mix to the specific supplier. Using hydropower data would substantially change the results, while not being justified in the decision-making context of Situations A and B.

### Provisions: 6.8.2 Technological representativeness

Applicable to Situation A, B, and C, differentiated.

Differentiated for attributional and consequential modelling.

Fully applicable for LCI results, LCIA results, and LCA studies. For unit processes only required to complete the system model for quality control.

Note that these provisions will be applied only in the LCI phase.

- I) **SHALL - Good technological representativeness:** The overall inventory data shall have an as good as required technological representativeness, meeting the goal requirements of the study. (See also the accuracy requirements identified in chapter 6.9.2; note that technological, geographical and time-related representativeness are closely interrelated). For both analysed processes and systems, this includes all quantitative and qualitative aspects of the functional unit(s) and/or reference flow(s), and/or technical specification(s). This applies especially for those aspects, that matter in terms of leading to relevant differences in the LCI data.
  - II) **SHALL - Specific way or mode of process?:** Identify along the goal of the study and especially the intended applications whether the data needs to represent a specific way or mode of operating the technology / technique (e.g. a specific load factor for transport, or a specific start, closure etc. cycle step of a process, etc.), if this differs from the average, typical or integrated operation. [ISO+]
  - III) **SHALL - Different technologies for attributional and consequential modelling:** Note that attributional and consequential modelling often require very different processes (and to some degree also systems) for the background system. But see the simplifications set for all Situations, except for the processes that face "big" changes in Situation B (chapter 6.5.4): [ISO!]
- III.a) **Attributional modelling:** It should be used:
- III.a.i) **Foreground system:** Technology-specific primary data for the foreground system and for the specifications of the products and wastes that connect the foreground system with the background system. Secondary data of the actual suppliers / downstream actors should be preferred to other (third-party) secondary data. Technology-specific, generic or average data from third-parties should be used in those parts of the foreground system where this for the given case is of higher quality (i.e. more accurate, precise, complete) than available technology-specific primary or secondary data from suppliers / downstream actors.
  - III.a.ii) **Background system:** Average technology as market consumption<sup>101</sup> mix data should be used.

<sup>101</sup> This also applies if a market production mix data set is developed: the fact that the data set is to represent the production mix would be achieved by combining the representative mix of producing technologies of that market according to their production share. For the data in the background system of the individual routes nevertheless the respective consumption mix data are to be used.

## Provisions: 6.8.2 Technological representativeness

III.b) **Consequential modelling:** It should be used:

III.b.i) **Foreground system:** The same applies as described above for attributional modelling. Here this includes the suppliers' / downstream actors' technology-specific secondary data of the contractually fixed or planned supply-chain.

III.b.ii) **Background system:** The short-term or long-term marginal technology mixes should be used, as appropriate for the applicable Situation A, B, C1, and C2. Among these, the named long-term technology mix only applies to those processes under Situation B that face "big" changes in consequence of the analysed decision, and - optionally - to the assumption scenarios. The technology mix of marginal processes should be identified, depending among others on the market conditions and the cost-competitiveness of the potential marginal processes.

The detailed provisions and terms / concepts are given in chapter 7.2.4.

III.c) **Using not fully representative data:** For both attributional and consequential modelling, not fully technologically representative data can be used only along the following conditions:

III.c.i) **For LCI and LCIA data sets / non-comparative LCI/LCA studies:** The use of not fully technologically representative data is justifiable only if this is not relevantly changing the overall LCIA results compared to using fully representative data; otherwise the lower achieved representativeness shall be documented in the data set / report. For data provided for a competitor's product, lower representativeness shall not lead to higher overall environmental impacts of the LCIA results calculated for that product. For data provided for own products or for products without any competition situation (e.g. generic data from consultants or research projects for general background use), lower representativeness shall not lead to lower impacts of the overall LCIA results calculated for that product.

III.c.ii) **For comparative LCA studies:** The conclusions or recommendations of the study should not be affected, as far as possible. Otherwise the lower achieved technological representativeness shall explicitly be considered when drawing conclusions and giving recommendations. Especially shall the use of less representative data not relatively disfavour any competitors' products to a relevant degree.

Note that this can be implemented only in the subsequent iterative steps of the LCA work.

IV) **SHALL - Non-scalable supplies:** For the life cycle model of Situation A, B, and C1, the following shall be applied: if the supply of a specific required function (e.g. product) cannot relevantly be increased in the analysed market and due to inherent constraints (e.g. as for hydropower in many countries) the market consumption mix of the specific function that the product provides (e.g. electricity in the above example) shall be used as far as possible, and not the data for the specific supplier/product. To not contradict the provisions on solving multifunctionality, this provision does not apply to required co-functions.[ISO!]

## 6.8.3 Geographical representativeness

(Refers to aspect of ISO 14044:2006 chapter 4.2.3.6.2)

### Introduction

The geographical representativeness of a process or system identifies how well the inventory data represents it regarding the location (e.g. market, site(s), region, country, etc.) that is documented in the descriptive information of the data set or report and where it is operated, produced, or consumed.

### Identifying the appropriate geographical scope of LCI data

The level and type of technology that is applied, and the conditions under which it runs (e.g. in terms of surrounding climate or national legal requirements on emission limits), are influenced by the geographical location of the process. Also to identify the mix of marginal processes (for consequential modelling) and the background data (for both attributional and consequential modelling) a correct identification of the geographical scope is required.

Apart from those processes where site or producer specific data is required, the data typically relates to a market. The below box briefly introduces the market concept:

#### Terms and concepts: Market

##### Market delimitation

In difference to other geographical concepts such as countries or regions, markets often have a different delimitation. The market in its sense for LCA is the unit that allows buyers and sellers to exchange any type of goods and services. Markets can be usefully differentiated

- geographically,
- temporally, and
- in customer segments (for the related concept "niche market" and its limitations in interpretation of related LCA study results see chapter 5.2.2).

The geographical scope is typically not exact as imports and exports occur across the market border. A useful delimitation is that no relevant amounts of such occur, respectively that imports and exports are considered when modelling e.g. consumption mixes for a given market. Reasons for the forming of markets are mainly

- political (legislation especially on competition and product requirements such as material bans, product safety, etc., technical and other standards, taxes, and subsidies), and
- cultural (recognised markets by producers and service providers).
- natural geographical aspects play a role when de facto isolating markets via barriers to transport (islands, large distances in general especially for low value/weight goods and for services that require human presence) and climate aspects of related products.

Markets can geographically be equal, smaller or larger than a country.

Temporal market segmentation is relevant for many services but also certain goods (e.g. intraday segmentation such as night time / base load electricity consumption, seasonal segmentation such as agricultural products and tourist industry).

Also the temporal segmentation is not always exact, as some aspects can be overcome via storage and transport (e.g. of fruits from the tropics to the moderate climate zones in the cold season, or solar power storage e.g. as hydrogen).

### Types of market related data set types

In LCA the main market related data set types of relevance are the market production mix, market supply mix, and the market consumption mix. The related text and figure in chapter 7.7 explain their relationship. Average or generic data that represent the consumption mix are the most widely required ones, while production mix data can be of interest for associations and for countries.

For niche markets see chapter 5.2.2

The geographical coverage of the LCI data should represent the smallest, appropriate geographical unit, depending on the goal of the LCI/LCA study and the intended applications. If e.g. the use of an energy-using consumer product in France would be the scope of the data set, the corresponding electricity market consumption mix (which is not automatically France<sup>102</sup>) and French product use conditions were to be considered, i.e. not European or Global average conditions. Generally, the degree of geographical or supplier-data differentiation, is to be decided considering the decision relevance and knowledge of decision makers about the market or specific supplier.

In attributional modelling this can be e.g. whether a material consumed in Malaysia has a specific producer that would need to be represented. Or whether it is from an unknown origin such as e.g. electrolytic raw copper which in Europe is usually traded on the London Metal Exchange with an European average origin. In the latter case, an average European consumption market data set would be most appropriate to apply for all European countries, as there are de facto no national markets.

In consequential modelling that would be the (short-term or long-term) marginal consumption market mix that would be operated as a consequence of a decision. This means that even if e.g. a material is currently predominantly produced for the national market, consequential modelling may identify one or more other countries as source if the growing demand is met by additional imports.

### Transfer of inventory data from a different geographical context

The use of data from one geographical area or specific supplier to another one is appropriate only if the differences in the environmental impacts have no or little relevance for the overall representativeness of the inventory. This is only given if applied technologies of that process, the way it is operated, abatement technologies, as well as the background system of that process (e.g. the raw material route, waste treatment, etc.) are very similar or at least result in very similar inventory values.

An example is when the use of a technology-specific Thai unit process data for a certain waste water treatment process with the same treatment efficiency but operated in another country in e.g. Vietnam would result in only insignificantly different inventories of the overall system (e.g. cloth washing) in which the waste water treatment process is used. Another example is the case that the production inventory of a consumer product may differ only

---

<sup>102</sup> Electricity markets are relatively difficult to delimit, given the internationally connected grids. In addition and related to the time-representativeness, it matters whether the named consumer good would be operated only at peak hours (e.g. an electric toothbrush) or continuously (e.g. a fridge) or only during night time at base load (e.g. an electric storage heater). These latter aspect is to be considered obviously under time-related representativeness (see related chapter).

insignificantly among different African countries, because they all imported from the same producing country, e.g. Japan<sup>103</sup>.

The above illustrates that next to the transferred unit process or LCI result data also process parameter settings are to reflect the correct geographical scope. This includes also management parameters such as e.g. achieved recycling rates.

### **Frequent errors: Use of LCI data with another geographical scope**

A frequent error in LCI/LCA studies is that data that represents one country is directly used for another country. Or that only limited adjustments are done (e.g. replacing only the electricity background data) without analysing which other adjustments may actually be relevant. Different markets and countries differ not only e.g. in the mix of energy carriers used (e.g. share hard coal, natural gas, nuclear power, etc.), but also the technologies how these energy carriers are converted to e.g. electricity, the way how these technologies are operated, the installed and operation of abatement technologies (if any), the sources / routes of the e.g. energy carriers and many others. What may look similar on a more general level is in fact often substantially different. It is to be stressed that using not sufficiently representative data renders the whole LCI/LCA study invalid and misleading.

While in practice limitations in data availability often require such transfer / adjustment of data, this is only valid and useful if the resulting data actually represents what it intends / claims to represent. A related risk is that the data that is used for another market may already from the beginning not be complete, i.e. it may even mislead focus for own data collection. An in-depths technical understanding of the to-be-represented processes is hence key also for any transfer and adjustment of data from other markets. Finally, If the differences and hence the main inventory values are known (what was argued to be indispensable in any case), there is little need to use data from other markets, except for rough cross-checking.

With an enlarged pool of consistent and quality-assured LCI data sets in the ILCD Data Network, the availability of consistent data should stepwise and substantially be improved over time and the need to use less representative data be minimised.

### **Relationship geography of LCI and of LCIA**

While the above relates to the general geographical scope of where processes are operated, the inventory items typically need a different differentiation (e.g. in which environmental media an emission goes). The default compartments are given in the separate document "Nomenclature and other conventions" and are implemented in the ILCD reference elementary flows.

Also the environmental issues of concern for the activity can vary with the geographical setting: the relevance of the use of e.g. water and construction materials that are typically extracted and used at a local to regional scale, is thus highly variable between regions. The impact assessment and interpretation may have to take this into account. This requires that elementary flows that act differently depending on where they are emitted (e.g. sulphur dioxide and particle emissions, while not carbon dioxide) would need to be reported spatially differentiated. This would allow the use of impact assessment methods with characterisation factors on e.g. resource-depletion that reflect the spatial differentiation.

However, only limitedly spatially differentiated impact assessment models are available (e.g. differentiating emissions to fresh water and sea water). Until models and factors have

---

<sup>103</sup> In that case the Japanese production or export data is correct as it represents the consumption market mix of all these countries.

been developed and tested in practice also for further sub-compartments and emission-situations or even location-specific, the use of spatially differentiated elementary flows directly in the data set inventories is discouraged. For the time being, the spatial information should be kept and documented separately (e.g. as second inventory set) to be able to adjust data and data sets later, if needed. This applies analogously to time-specific models, methods, and factors.

Please also note that the exact degree and way of spatial differentiation is still to be determined in LCIA context, i.e. whether to divide by national boundaries (countries), natural geographical units or sub-units (continents and landscape zones), sub-compartments of the environment (e.g. different types of water bodies), emission situations (e.g. in areas with high or low human population density), or by geographical coordinates via a global impact grid, etc. This will need to be closely coordinated with data availability especially in industry, LCI modelling needs, review questions, and software and database management implications.

### Provisions: 6.8.3 Geographical representativeness

Applicable to Situation A, B, and C, differentiated.

Differentiated for attributional and consequential modelling.

Fully applicable for LCI results, LCIA results, and LCA studies. For unit processes only required to complete the system model for quality control.

For LCI results, LCIA results, LCA studies: be aware that the declared geographical scope of all later to be used inventory data needs to enable a correct impact assessment. This is to be checked especially carefully if a non-generic impact assessment (e.g. with differentiated characterisation factors by country, region or even site) is applied.

Note that these provisions will be applied only in the LCI phase.

- I) **SHALL - Good geographical representativeness:** The overall inventory data shall have an as good as required geographical representativeness, according to the goal of the study (see the accuracy requirements identified in chapter 6.9.2). This applies especially, where this matters in terms of relevant differences in the LCI data of different geographical scope.
- II) **SHALL - Different geographical scope for attributional and consequential modelling:** Note that attributional and consequential modelling may require processes/products of a different geographical scope in the background system. But see the simplifications set for all Situations, except for the processes that face "big" changes in Situation B (chapter 6.5.4): [ISO!]
  - II.a) **Attributional modelling:** It should be used:
    - II.a.i) **Foreground system:** Site or producer/provider specific data for the foreground system, supplier-specific data for the products that connect the foreground with the background system. Generic data of geographical mixes can be used also in parts of the foreground system if for the given case justified as being more accurate, precise, and complete than available specific data (especially for processes operated at suppliers).
    - II.a.ii) **Background system:** Average market consumption mix data for the background system.
  - II.b) **Consequential modelling:** It should be used:
    - II.b.i) **Foreground system:** Site or producer/provider specific data for the

directly controlled processes of the foreground system, suppliers' site specific data of the contractually fixed or planned supply-chain of the foreground system plus for the products and wastes that connect the foreground with the background system. Generic data of geographical mixes can be used also in parts of the foreground system if for the given case justified as being more accurate, precise, and complete than available specific data (especially for processes operated at suppliers).

- II.b.ii) **Background system:** The short-term or long-term marginal geographical mixes should be used for the background system, as appropriate for the applicable Situation A, B, C1, and C2. The geographical mix of the marginal processes should be identified, depending among others on the market conditions and cost-competitiveness of the potential marginal processes.

The detailed provisions and terms/concepts are given in chapter 7.2.4; but check for the simplified provisions for the applicable Situation A, B or C in chapter 6.5.4.

- II.c) **Using not fully representative data:** For both attributional and consequential modelling, not fully geographically representative data can be used only along the following conditions:

- II.c.i) **For LCI and LCIA data sets / non-comparative LCI/LCA studies:** The use of not fully geographically representative data is justifiable only if this is not relevantly changing the overall LCIA results compared to using fully representative data; otherwise the lower achieved representativeness shall be documented in the data set / report.

- II.c.ii) **For comparative LCA studies:** The conclusions or recommendations of the study should not be affected; otherwise the lower achieved geographical representativeness shall explicitly be considered when drawing conclusions and giving recommendations. Especially shall the use of less representative data not relatively disfavour any competitors' products in a relevant degree.

## 6.8.4 Time-related representativeness

(Refers to aspect of ISO 14044:2006 chapter 4.2.3.6.2 and 4.3.2.1)

### Introduction and overview

Technology changes over time. What has been best available technology 10 years ago may today be the average technology, or even already outdated in sectors of rapid technological progress (e.g. IT, solar-electric systems, etc.). The average technology from 10 years ago may already be decommissioned or only contribute a small share to the current market mix, except for sectors with long-running production plants (e.g. for many basic materials, power plants, etc.). Thus, the temporal representativeness is closely linked to technological representativeness.

The inventory of a process or system that is to represent a certain time context (e.g. present or near future situation, "2025", or for a baseline scenario for accounting "1990") is to be based on data that sufficiently appropriately represents that declared time. That is especially important for the quantitatively most relevant contributors to the overall environmental impact. Note that the time representativeness of the data to be used should also be in line with the intended application.



## The represented year, especially on system level

The represented year of a system data set cannot always be determined straightforward: the single data values already for unit processes may stem from different sources and years. On a higher level, the unit process data sets that are combined in a system often represent different years. Which year a data set represents, is to be determined by looking at the different ages of the main contributing data (in case of unit processes) or unit processes (in case of LCI results). Weighing their contribution and age and reflecting the speed of changes of the different technologies / techniques over time the best represented year can be given by expert judgement. Figure 27 illustrates this concept.

### Frequent errors: Misleading/wrong use of "time representativeness"

It is important to note that the time representativeness always refers to the actual time represented and determined e.g. by measurement, NOT the time when a used secondary data source had been published or the modelling / calculation year of the unit process or LCI results. It is a frequent error in LCA to confuse this fundamentally different age information, including when declaring in a misleading way the claimed time-representativeness of distributed LCI data sets.

Reflecting on what has been said before on the speed of technology development in different industries, data of several years age, may still be sufficiently representative. Data sets should therefore show an "expiry year" after which they can be assumed to be not sufficiently representative any more and typically will need revision.

If such data is nevertheless used in a study, the data have a lower than declared time-representativeness and it is to be judged how strongly this effects results, conclusions, and recommendations.

### Intra-annual and intra-day variations

Another time-aspect, which may need to be considered in special cases, is the difference of inventory data in the course of the year (especially hot and cold season) and the day (daytime / night). It is to be checked along the goal of the study whether such intra-annual or intra-day specific data might be needed (e.g. on night-time electricity base-load data for charging electric car batteries over night).

### Intended application and required time-representativeness

The need for time-related representativeness is very much influenced by the intended application and its requirements on e.g. future validity of the results and conclusions that can be drawn from the LCA results: e.g. for studies in support of procurement and especially of products with a short life time, the use of data with a 1 year validity may be fully sufficient. Ecolabel criteria are typically revised regularly (e.g. every three years), and the need for future validity of data sets used to support the identification and quantification of the criteria is thus confined to this time horizon. Decisions made in the ecodesign of long-living products may be valid for 10 years. In the extreme, LCAs made to support decisions on choice of products with a long life-time (e.g. production plants, houses) or answering strategic questions may be required to provide conclusions and recommendations that strive at being valid for 20 to 30 years into the future. This points to the need in such cases to use future-related foreground scenarios and background data for the use / operation and end-of-life stages of these systems rather than present/recent ones.

## Time-representativeness of future and past processes

Many studies of high relevance - e.g. those under Situation B - relate to the future. Also the processes along the life cycles of long-living products and e.g. interventions from landfills under Situation A relate to different time-horizons, including the long-term future.

The following general provision applies for all future and past processes<sup>104</sup>: Data should be as time-representative as possible and any lack of representativeness shall be documented and considered in the results interpretation. Limited time-representativeness in comparative studies shall not relatively disfavour any competitors' products. This can be operationalised as follows:

- Processes operated within 5 years into the future or past:
  - The most recent data that is still valid for that to-be-represented time should be used. In the case the data is already outdated (e.g. is not sufficiently valid anymore for the year of recycling), new data should be collected or obtained.
- Processes operated more than 5 years into the future or past
  - Fully time-representative data, i.e. forecasting data (or, for processes in the more remote past: historical data) should be used.
  - As second option, and especially for attributional modelling, the mix of the Best Available Technologies (BAT)<sup>105</sup> should be used.
  - As third option the present / most recent available data can be used, along the following conditions:
    - The use of less time-representative data should be justifiable only if not changing relevantly the LCIA results of the LCI/LCA study compared to using fully time-representative data; otherwise the lack of time-representativeness shall be documented.
    - For comparative studies the conclusions or recommendations of the study should not be affected; otherwise the lack of time-representativeness shall be considered explicitly when interpreting the results. Especially shall the use of less time-representative data not relatively disfavour any competitors' products in a relevant degree.

Related but also different from the question of time-representativeness of a process is the question of how to inventory the future interventions (e.g. emissions from landfills). Another related issue is carbon storage and delayed emissions (e.g. in bio-based goods or from long-living products). These two topics are discussed and guidance is provided in chapter 7.4.3.7.

### Provisions: 6.8.4 Time-related representativeness

Fully applicable for LCI results, LCIA results, and LCA studies. For unit processes only required to complete the system model for quality control.

<sup>104</sup> Note that all this applies analogously for past processes, if they are part of the analysis and model.

<sup>105</sup> BAT mix example: If the present technology-routes mix for end-of-life product treatment of the analysed product would be 60% incineration with energy recovery and 40% closed-loop material recycling, the BAT mix would combine 60% of the BAT technologies for incineration with energy recovery and 40% of the BAT technologies for material recycling.

Note that these provisions will be applied only in the LCI phase.

- I) **SHALL - Good time-related representativeness:** The overall inventory data shall have an as good as required time-related representativeness, according to the goal of the study (see the accuracy requirements identified in chapter 6.9.2). This applies especially, where this matters in terms of relevant differences in the LCI data that represent a different time.

Note that the represented year of a process or system shall refer to the actually represented year and not the year when the data set was calculated or the year of publication of used secondary data sources.

- II) **SHALL - Specific seasonal or diurnal situation?:** Check along the goal of the study and the intended applications whether the data needs to represent a specific seasonal or diurnal situation, if this differs from the average annual data. [ISO+]

- III) **SHOULD - Time-related representativeness of future processes:** For processes that run more than 5 years in the future or past from the time of study (e.g. of the use and end-of-life stage of long-living products or in case of backward looking analysis), fully time-representative future/past scenario data should be used, if possible. If this is not possible: [ISO!]

III.a) **BAT and recent data:** For both attributional and consequential modelling, Best Available Technology (BAT) mix data should be used as second option, if BAT data can be argued to be sufficiently representative for the required time. The most recent data are the third option.

III.b) **Using not fully representative data:** Not fully time-representative data can be used only along the following conditions:

III.b.i) **For LCI and LCIA data sets / non-comparative LCI/LCA studies:** The use of not fully time-representative data is justifiable only if this is not relevantly changing the overall LCIA results compared to using fully time-representative data; otherwise the lower achieved time-representativeness shall be documented in the data set / report.

III.b.ii) **For comparative LCA studies:** The conclusions or recommendations of the study should not be affected; otherwise the lower achieved time-representativeness shall explicitly be considered when drawing conclusions and giving recommendations. Especially shall the use of less time-representative data not relatively disfavour any competitors' products in a relevant degree.

Note that time-related inventorying issues and how to inventory e.g. carbon storage and delayed emissions is necessarily addressed in the LCI chapter 7.4.3.7.

## 6.9 Types, quality and sources of required data and information

(Refers to aspects of ISO 14044:2006 chapter 4.2.3.6.2)

### 6.9.1 Introduction and overview

(Refers to aspect of ISO 14044:2006 chapter 4.2.3.6.2)

During the initial scope definition and in preparation of the subsequent work, the main types and sources of data and other information should be identified. These initially identified

types and sources will be more detailed and often also revised during the iterative steps of inventory data collection and modelling, impact assessment, and interpretation.

Types of required data and other information comprise - depending on the deliverable and type of study - e.g. inventory information, statistical data, technical process / system information, market information, allocation-related information, as well as legal and other boundary conditions.

Note that LCIA methods are required (at least for supporting the quantification of the achieved data completeness / cut-off). Also normalisation data and weighting factors may be required.

For identifying the data and information needs and suitable sources, the required overall data quality is the key measure. It has been derived directly or indirectly from the goal of the LCI/LCA study in the chapters on completeness / cut-off criteria (6.6), representativeness (6.8), and precision (6.9.2). The equally relevant methodological appropriateness and consistency relates to the various method-related chapters of this document. For quality of third-party data sets that may be required, additional quality aspects relate to documentation, nomenclature and review.

Unless the required precision is directly fixed in the goal (e.g. "modelling of a high-quality LCI data set of maximum XY% overall uncertainty (or: for each single impact category)") or unless specific, previous experience exists, the quality requirements on inventory data can only be identified after the first rough model of the life cycle has been established. It is then revised in context of the iterative improvement of the inventory (see Figure 5).

## 6.9.2 Data quality needs in light of the intended applications

(Refers to aspects of ISO 14044:2006 chapters 4.2.3.6.2 and 4.4.2.2)

### Relative relevance of accuracy, completeness, and uncertainty/precision

Data quality is composed of accuracy (i.e. representativeness and methodological appropriateness and consistency), precision / uncertainty and completeness of the inventory<sup>106</sup>. All of these contribute to the overall quality and typically the weakest of them determines (lowers) the overall data quality. In general in LCA, the relatively lowest quality can typically be found regarding representativeness, methodological appropriateness and consistency (especially on system level), and completeness. These show the greatest need for improvement in LCA practice. Also, LCI related information often lacks quality, e.g. actual market prices in case of economic allocation under attributional modelling and forecasted market prices in support of identifying marginal processes in consequential modelling. The uncertainty of the data (that relates to stochastic uncertainty of measurements) in contrast is argued to often be of comparatively less relevance in practice, although it must not be disregarded, of course, as it can well lower otherwise high quality data.

### Determining data quality requirements for single data values in view of the aggregated LCIA results

Data quality of LCA starts from the quality of the single inventory data values, and goes back even beyond to the raw data obtained. The required overall quality of the single data values and unit processes typically can only roughly be derived from the goal and the related overall quality requirements: the required overall quality on data set or system level is to be identified first. Only then these requirements can be translated to the level of the elementary

---

<sup>106</sup> For the concepts and components of data quality and data set quality see annex 12.

flows for which data is collected in the inventory. This can generally be done only after the first iteration of the LCA, i.e. not initially:

This translation requires knowing the elementary flows' characterisation factors for the different impact categories and bring this information together with knowledge of the inventory. E.g. Climate change may be an important impact of an analysed system. In the contribution analysis it may turn out that one specific process contributes with e.g. about 95 % to the overall Climate change impact potential due to a high emission of methane. In this case it is very important to have a high quality on the data for this emission. In contrast, the emissions of e.g. CO<sub>2</sub> from transport, energy conversion processes, etc. as part of the same system can be far less precise, as they in total contribute only little to the overall impact. While it requires initial analysis of the life cycle, in practice it is often only a rather limited number of emissions and processes that relevantly contribute to the overall impacts. It is key to correctly identify and focus on these in the described iterative approach; this is described systematically in chapter 4.

### 6.9.3 Inventory data needs and sources

(Refers to aspect of ISO 14044:2006 chapter 4.2.3.6.2)

#### Introduction

For an LCA study, two types of data are usually required:

- specific inventory data on the one or more newly to be developed process(es) of the foreground system, and
- average or generic (for attributional modelling) or (mix of) marginal processes (for consequential modelling) for the background system.

It is important that all foreground and background data used in a LCI/LCA study are methodologically consistent and that the overall quality requirements for the analysed system are met.

Note that the required processes and hence data sets for attributional modelling are typically different from those for consequential modelling.

#### Primary data (towards developing specific unit processes)

For specific unit process data measurements at the operated processes are the as preferred option. In practice a range of other data sources is helpful (e.g. for cross-checks) or even necessary (e.g. in case of missing data). These are e.g. patents, process engineering models, stoichiometric models, process and product specifications and testing reports, legal limits, data of similar processes, BAT reference documents, and many others.

As this is an operational and case-specific question it is addressed in the LCI chapter 7.3.

#### Available data sets (primary and secondary)

It is recommended to prefer well documented third party data sets as a good documentation supports correct use, quality assessment, and eases review. Equally, for secondary background LCI data sets pre-verified data (e.g. via the ILCD Data Network) are recommended, as this reduces the efforts of own verification/review: the data itself will not require any additional review, only the correct selection and use in the analysed system model is to be reviewed.

Note that for published studies the required level of review (e.g. independent external review or independent review panel) may differ for non-comparative LCA studies and comparative studies. See chapter 6.11.

Sources for available inventory data are very diverse:

- LCI data providers for the foreground system are typically the developer or producer and/or operator of the analysed process or system and their suppliers. Often market average data is provided by business associations; this data is typically of use for the background system. These industry sources are also named "primary data suppliers".
- Secondary data providers, typically for the background system, are national and international LCI databases, consultants, and research groups.

The ILCD Data Network gives access to all ILCD compliant data from any kind of data provider. By working with an ILCD compliant and appropriate documentation, using the same nomenclature and elementary flows, etc. such data eases to work in line with the ILCD Handbook.

More details on LCI data and information collection and modelling are addressed in the LCI chapter 7.

## 6.9.4 Other inventory-related data and information needs and sources

(Refers to aspect of ISO 14044:2006 chapter 4.2.3.5)

Depending whether attributional or consequential modelling principles and the related allocation or substitution approaches are to be applied, in addition to inventory data itself further data and information may be required to support the application of these methods. Which type of data is required strongly depends also on the type of deliverables of the LCI/LCA study and the specific case. Examples are market mix data of technologies, import/export statistics, and recycling rates. Furthermore, especially for consequential modelling: long-term economic market competitiveness of technologies and related future market price scenarios, user behaviour data / surveys and models on reactivity of different consumer groups, policy scenarios and their effect on future markets, experience and learning curves of technologies, and many more.

Statistical agencies provide among others production, import/export and market statistics data. Equally market organisations and business associations provide such statistical data as well as other product-related information such as e.g. recycling rates and recycled contents. Regarding market prices and scenarios, technology foresight, policy scenarios, user behaviour and others, specialised research and consulting organisations, governmental organisations and business organisations work on these topics.

The most suitable sources are to be identified in context of the specific LCI/LCA study.

## 6.9.5 Impact assessment models and factors, normalisation basis, and weighting set needs

(Refers to ISO 14044:2006 chapters 4.2.3.6.2 and 4.4.2.2)

Regarding the identification of suitable LCIA methods see chapter 6.7. Sources for LCIA methods are e.g. dedicated LCIA method developers or national and international LCA projects.

Regarding the identification of suitable normalisation data and weighting sets see chapter 6.7.6. Sources for normalisation and weighting data are national LCA projects and respective recommendations of governmental bodies.

## Provisions: 6.9 Types, quality and sources of required data and information

Applicable to Situation A, B, and C, implicitly differentiated.

Differentiated for attributional and consequential modelling.

Fully applicable to all types of deliverables, implicitly differentiated.

Some of the steps can be done only after the first iteration.

- I) **MAY - Overview of the principle types of data and information:** It is recommended to prepare an overview of the principle types of data and information that will be required depending on the type of deliverable of the LCI/LCA study, unless this is done in the later step on "Planning data collection" (chapter 7.3). Depending on the study, these are e.g. technical information of the analysed process(es) or system(s), use and end-of-life management data/information, raw inventory data for foreground processes, statistical data e.g. on international trade, market delimitation information and other market characteristics, generic or average background LCI data sets, LCIA methods data sets, normalisation and weighting data, legal and other boundary conditions, etc. The previous scope chapters should be re-checked, including on different data representativeness needs for attributional and consequential modelling. (6.9.1)

Note: the detailed inventory-related data needs will be identified in the Life Cycle Inventory work (see 7.3).

- II) **SHOULD - General requirements on data and data set quality:** Determine the general requirements on data and data set quality (details, terms and concepts see annex 12). Regarding newly collected LCI data this means the needs for representativeness, completeness, and precision. For third-party LCI data sets in addition method appropriateness and consistency, the use of ILCD-consistent elementary flows and nomenclature, appropriate documentation, and (potentially) an external review. (6.9.2)

Note that unless the quality requirements are directly quantified in the goal, the initial data and data set quality requirements can be set only after the first loop of data collection, results calculation, impact assessment, the identification of significant issues, and the evaluation. This is described in more detail in chapter 4. These requirements will typically need to be revisited and refined in the subsequent iterations.

- III) **SHOULD - Potential sources for the required data, data sets, and information:** It is recommended to already identify potential sources for the required data, data sets and information, as far as possible. Details are decided in chapter 7.3 on "Planning data collection" (6.9.3, 6.9.4):

III.a) **Well-documented data:** Well-documented data and data sets should be preferred to allow judging the data appropriateness for use in context of the analysed system and to enable the (potential) critical reviewer to be able to perform an independent verification (6.9.3). [ISO!]

Note that if the deliverable of the study is intended to support comparisons, a minimum documentation scope is specified; see chapter 10.3.3.

III.b) **Pre-verified data:** It is recommended to prefer the use of externally and independently pre-verified data and data sets, as this provides an assurance of the claimed quality and reduces the effort and costs for review of the LCI/LCA work (6.9.3). [ISO+]

Note that different types of critical review are mandatory for different types of deliverables and applications (see 6.11).

Note: The ILCD Data Network is one suitable source for primary and secondary LCI data sets and potentially for

LCIA methods. The related requirements make these data especially suitable for working in line with the ILCD Handbook. Statistical agencies, trade associations, governmental bodies, consultants and research groups are potential sources for data, data sets, and information.

## 6.10 Comparisons between systems

(Refers to ISO 14044:2006 chapter 4.2.3.7)

### 6.10.1 Introduction and overview

(Refers to aspect of ISO 14044:2006 chapter 4.2.3.7)

A comparison of (product) systems is already an application of LCA, while it is covered within the general LCA standards ISO 14040 and 14044:2006. For valid comparisons a few additional aspects are to be considered. Studies that involve comparative assertions that are foreseen to be published must meet additional requirements in order to be valid, fair and hence non-misleading. ISO 14040 and 14044:2006 pose a number of further requirements on such studies. Apart from the issues addressed in this chapter these relate to review and reporting; see chapters 11 and 10.3.3. This is reflecting the consequences that the comparative use of LCA results may have for other companies, institutions and stakeholders that are not directly involved in the study.

A life cycle impact assessment shall be performed for studies intended to be used in comparative assertions intended to be disclosed to the public.

#### **Terms and concepts: “comparison” vs. “comparative assertion disclosed to the public”**

“Comparison” relates to the LCA-based comparison of the overall environmental impact of two or more systems that may or may not provide the same function. Such studies can be worked out on-demand in an LCA study, be based e.g. on available EPDs, apply ecodesign tools, etc. The results are used either internally for decision support or are published. Of interest here are the cases that are published.

“Comparative assertion” in contrast means that the superiority, inferiority or equality of alternatives is claimed based on the LCA. The addition “disclosed to the public” means that these conclusions of superiority or equality are published to the general public (i.e. are made available outside a small and well defined list of actors that were involved in the LCI/LCA study).

The term "comparative study" covers in this document both cases, i.e. both assertive and non-assertive studies that compare alternatives.

### 6.10.2 Strengthening affected stakeholders in non-assertive comparisons and multi system type studies

#### **Types or comparisons and affected stakeholders**

The following types of comparisons can often be found in published LCA studies:

- systems or processes with the same or similar functional unit are compared with each other (e.g. different brands of 20" TV sets, or: potato cropping in country X comparing integrated, conventional, biological, and low input farming)



- variants of a system are evaluated (e.g. design or material alternatives of a brand-unspecific, i.e. generic or brand X specific kitchen chair)
- a contribution or weak point analysis of a specific system is done (e.g. analysing the impact share of production stage vs. use stage vs. end-of-life stage of a vacuum cleaner Z, or: of the main contributing processes, materials, energy carriers, or services, etc. of a vacuum cleaner Z)
- a multi-system type study analysis several systems with different functional units or functions (e.g. a basket-of-products type study of an average citizen of country A, or: a prioritization study on the most impacting products in a country B, or: the overall environmental impact (or: per average citizen) of countries A, B, and C is compared)

ISO 14044:2006 has a set of stricter requirements for studies that compare systems and make assertions on superiority, inferiority (and implicitly also: equality) of the compared systems. This is to strengthen the interests of the affected stakeholders, avoiding the misuse of LCA in market competition. In the above examples the affected stakeholders are (at least):

- the different TV set producing companies (first bullet, first example)
- the farmers and the downstream production chain that produce/use potatoes from the respective farming methods (first bullet, second example)
- the producers of the alternative materials (second bullet)
- the producers of the product groups that show the highest impact in the basket-of-products and the prioritization study (forth bullet, first and second example)
- the governments/people of the compared countries (forth bullet, last example)
- In the case of the system-internal weak point analysis (third bullet) it is argued that the potential effect on the producers/service providers is limited, as related to a small market share

### **Strengthening stakeholder interests**

The publication of comparisons without claiming superiority of one alternative while showing e.g. the results on level of impact indicators leaves it to the recipient to draw the conclusions of superiority/inferiority. This can be understood to be a misleading use of LCA, as the conclusions affect the "loosing" entities that represent the compared systems. This can be via purchase decisions, impacts on the image, political measures that build on such studies, etc. To protect the affected stakeholders, such studies shall at least state that the study does not support to draw conclusions or recommendations on the superiority or equality of any of the analysed systems. Finally, to avoid misinterpretation by non-technical audience or the general public, the study shall meet the same review and other requirements that apply to "comparative assertions disclosed to the public".

To avoid this, the ISO requirements on "comparative assertions disclosed to the public" shall also be applied to "product comparisons disclosed to the public". Exceptions are contribution and weak point analysis type studies on specific products / brands (see example in third bullet in the above list of types).

## 6.10.3 Considered alternatives, the functional unit, and assumptions

(Refers to aspect of ISO 14044:2006 chapter 4.2.3.7)

### Studies on systems that are meant to be functionally comparable

In the classical case of comparative studies, the aim is to conclude the superiority, inferiority or equality of the compared alternatives and - typically - come up with recommendations.

Two aspects related to the “what is compared” issue are important for those studies that look into system that are meant to be comparable: the equivalence of the functional unit of compared alternatives and the non-misleading selection of the compared alternatives.

The equivalence of the functional units was already addressed in chapter 6.4.7. It is required for comparative LCAs that are to be published. In the case that some of the aspects of the functional unit differ significantly between the systems, it shall be ensured that:

- either the functions that the compared systems provide, are still seen as sufficiently comparable by the main stakeholders affected by the LCA study and the product users
- or the sufficient comparability is to be achieved by the respective provisions for attributional modelling (typically, but with exceptions: allocation) and for consequential modelling (typically, but with exception: system expansion). Details for Situations A, B, C<sup>107</sup> see chapter 6.5.4.

For both options a close involvement of stakeholders and product users (or their representatives) is to be foreseen.

### Selection of compared alternatives

As to the inclusion or exclusion of compared alternatives, it should be ensured that the comparative assertion is not misleading by leaving out existing or even widely used alternative products that may perform environmentally clearly better than the compared alternatives. In the case such alternatives are left out, this shall be highlighted visibly in the interpretation including when drawing conclusions and giving recommendations, as well as in the executive summary.

### Selection of specific scenarios to be compared

Often also the application context of the products is to be considered carefully as part of the functional unit, as it may render products with the same general functional unit to perform differently: E.g. may a hybrid-vehicle with internal combustion engine and propulsion battery / electric motor perform somewhat better than a conventional vehicle with internal combustion engine, if analysed for an average use pattern. If long-distance overland transport is looked it, it may however perform clearly less good, while it may perform much better for predominantly inner-city transport. I.e. first the general technical specification of such products needs to be transformed into a functional unit that considers average or specific operation conditions of the product. Please note however that for comparative assertions that will be published, the choice of a specific application context may fulfil the criteria of

---

<sup>107</sup> Note that product comparisons usually imply a decision-context. This again implies system expansion to be used here. The use of the attributional approach of allocation is only applicable in the foreseen exceptions and the cases of Situation C (e.g. accounting of progress over time in the environmental performance of specific products, product groups or functions) that need an adjustment for functional equivalence. Check carefully along the applicable goal situation A, B, or C, which approach is to be chosen (see chapter 5.3).

misleading goal definition, e.g. by using very unusual application contexts. Studies that look into a-typical or otherwise specific scenarios shall highlight this fact visibly in the interpretation including when drawing conclusions and giving recommendations, as well as in the executive summary.

### **Durability**

Among the positioning properties the durability of the product plays a special role, as it is directly related to the product's functional unit, and addressed there. An example is e.g. a wall hanging kitchen cupboard comparison for a house of 40 years use. Alternative A of 10 years life-time needs to be replaced three times to provide the same functional unit as another one with 15 years life time that needs replacement twice. Such has to be quantitatively considered, using the technical life-time of the alternatives as basis for published comparative assertions. The above example illustrates a second issue: the selection of the functional unit (here e.g. "providing wall-hanging kitchen cup-board space of X m<sup>3</sup> for 40 years") can result in advantages/disadvantages for compared alternatives due to the specific values chosen. In the above example the 40 years relatively disfavour product B, because the three sets that are required to provide the functional unit for the defined 40 years still function for another 5 years (three times 15 years = 45 years). The same can apply to the chosen amount of m<sup>3</sup>, as just another aspect of the above example. To ensure a fair comparison, the chosen functional unit shall reflect a well justified typical or average case and be agreed with the affected stakeholders in a best attainable consensus.

Other life-time considerations should be considered in the scenario analysis, such as fashion life-time, mechanical integrity life time, technical innovation life time, cost of reuse vs. replace considerations etc. Note that legally required minimum guarantees are usually not suitable.

Note also that in comparisons of product alternatives with different life times, the replacement of the alternative with the shorter life time will usually be done with a newer model that is technically equivalent and available at the time of replacement. This should be considered explicitly in the model, unless a different agreement can be achieved among the affected stakeholders.

### **Other qualitative aspects of the functional unit**

Depending on the specific system, a range of other qualitative system properties plays a relevant role; this is to be evaluated for the given case. Examples are e.g. cleaning, servicing, repair needs, but a range of other kinds of positioning properties are to be checked.

## **6.10.4 Methodological, assumptions and data consistency**

(Refers to aspect of ISO 14044:2006 chapter 4.2.3.7)

Of particular importance is to ensure consistency of the methods, assumptions and data used in the LCA study for all compared systems. Consistency is crucial when defining the functions, functional units and reference flows, the system boundaries, the requirements on representativeness (time-related, geographical and technological), completeness and precision of LCI data, the LCI modelling principles and approaches applied, as well as applied LCIA methods.

## 6.10.5 Data quality requirements

(Refers to aspect of ISO 14044:2006 chapter 4.2.3.7)

In studies comparing systems, the overall data quality requirements depend on the relative difference of the overall environmental impact between the compared systems: For an LCA performed e.g. in support of ecodesign decisions, comparing two or more alternative designs, the requirements may be modest if one of the alternatives has much lower impacts than the others. The initial overall data quality requirements are hence to be revised when the results of the first calculation of inventory and impact assessment are available.

Regarding the completeness, for comparative assertions, and next to the overall environmental impact the cut-off criteria shall be applied also to mass and energy.

## 6.10.6 Identical parts of the compared systems

(Refers to aspect of ISO 14044:2006 chapter 4.2.3.7)

When looking at alternatives in specific parts of otherwise identical or similar systems, the rest of the compared systems is often<sup>108</sup> identical. Examples are comparing material alternatives for parts of a product, or comparing alternative electricity sources in the energy efficiency in the use stage of an electricity using product. If the sole purpose of such a comparison is to decide which system has the lowest environmental impact, as is often the case in applications for product improvement in ecodesign or for procurement, all those parts of the systems that are identical, can be left out when drawing the system boundaries. This can drastically reduce the effort for the LCA study.

However, this is only possible, when they are actually identical: even apparently identical parts may in fact not be identical: E.g. the same amount of the same aluminium alloy used in the same component of two alternative product models may be left out. This shall not be done if the alloy is used in different components of these models, as the inventories of the alloys are only partly correlated in the second case. They should hence be kept in and their partial correlation shall be considered when interpreting differences.

Note that the intended applications may not permit to leave out identical parts, e.g. if also the total overall impact is required or if the share of impact of parts in relation to the total shall equally be analysed, etc.

## 6.10.7 Scenarios in support of comparisons

(Refers to aspect of ISO 14044:2006 chapter 4.2.3.7)

Reasonably best case / most likely case / reasonably worst case scenarios (plus optionally other scenarios) shall be performed for comparison of systems: data and method assumptions are varied to investigate the robustness of the results. Such scenarios support the later results interpretation. For comparative micro-level decision support studies (i.e. Situation A), examples for such method and data assumptions are inventory data values, parameters, relevant flow properties, relevant system properties / aspects of the functional unit, but also method assumptions including method approaches such as allocation, the mix of superseded processes used in substitution, and the like; the "shall" provisions of this document shall still be met however. These data and method assumptions are to be identified among the "significant aspects" (see chapter 9.2).

---

<sup>108</sup> Note however that changes in specific parts of a product can induce other changes that must be explicitly considered (see related box on part-system relationships in chapter 7.2.2).

Uncertainty calculation shall be used to support the comparison of systems, especially to identify whether differences can be considered significant or too small to justify the superiority of one system over the other.

For comparative meso/macro-level decision support studies (i.e. Situation B), a more extensive use of scenarios is necessary to ensure that the decision support is robust. In difference to Situation A, in Situation B and here exclusively for the assumption scenarios also the provisions of this document can be changed. That means e.g. that also fully consequential or fully attributional scenarios can be performed, if the affected stakeholders come to a best attainable consensus on their integration and definition (see also chapter 7.2.4.2 and 7.2.4.3).

Next to uncertainty calculations, also scenarios can be used to help capture the reliability of the data results of Situation C studies.

## 6.10.8 Carbon footprint studies and other selected comparisons

(No corresponding ISO 14044:2006 chapter)

The remainder of chapter 6.10 on comparisons of systems equally applies to Carbon footprint studies, except for limiting the question of significance to the Climate change relevant emissions.

Note however that published comparisons or comparative assertions based on Carbon footprint or other selected indicators or impact categories shall be justified by demonstrating that the compared alternatives do not differ in other relevant environmental impacts to a degree that would change the conclusions and/or recommendations of the comparison. Otherwise such studies are considered misleading.

### Provisions: 6.10 Comparisons between systems

Note that restrictions apply to studies under Situation C1 and C2 for use in decision support.

Differentiated for attributional and consequential modelling.

These provisions are mandatory (shall) only for comparative LCA studies that analyse more than one system or system variants. It is recommended to also apply them analogously to non-comparative LCA studies that include a system internal contribution / weak point analysis.

These provisions also apply to LCI studies and data sets that are intended to be used in context of comparative studies (e.g. as background data).

These provisions are planning items that need to be considered in the later LCI, LCIA and Interpretation phases and for reporting and review.

Note: these Provisions partly compile provisions from other chapters and reproduce them here in a condensed way; the complete and binding conditions are found in the referenced chapters.

#### For all comparative studies:

- I) **SHALL - Non-assertive, comparative studies:** The ISO 14044:2006 provisions for comparative assertions shall also be applied to non-assertive, comparative studies. Both types together are grouped under the term "comparisons" in this document. (6.10.2). [ISO!]
- II) **SHALL - Consistency:** All elements of the scope definition shall be addressed consistently for all systems to be compared, as far as possible. Otherwise, the lack of consistency shall be reported and be considered explicitly when interpreting the results,

### Provisions: 6.10 Comparisons between systems

giving conclusions or recommendations. Especially: (6.10.3)

- II.a) **LCI model:** The compared system models shall be constructed in an analogous way applying the same rules for system boundaries, LCI modelling principles and method approaches.
  - II.b) **Assumptions:** Methodological and data assumptions shall be made in an analogous way.
  - II.c) **Data quality:** The achieved completeness, accuracy and precision of the data shall be sufficiently similar for the compared systems.
- III) **SHALL - Uncertainty and accuracy calculations:** Calculations on the stochastic uncertainty and accuracy shall support this analysis. This is not required if uncertainty calculations have already been used to derive the reasonably best and worst case scenarios. (6.10.4)
- IV) **SHALL - Completeness / cut-off:** The cut-off % that has been defined in chapter 6.6.3 shall also be met for mass and energy, next to for the overall environmental impact.
- V) **SHALL - Excluding identical parts:** If included processes / systems of the compared systems are identical for all alternatives, they may be left out of all models. Included processes / systems that are similar but not identical shall remain in the model, but their partial correlation shall be considered when interpreting differences. [ISO+]
- Note that the intended applications may not permit to leave out even identical parts.
- Note that even apparently identical parts may only be left out of the comparison if they are truly identical. E.g. the same amount of the same aluminium alloy used in the same component of two alternative models may be left out. This shall not be done if the alloy is used in different components of these models, as the inventories of the alloys are only partly correlated in the second case. (6.10.5)
- VI) **SHALL - LCIA to be performed:** A Life Cycle Impact Assessment shall be performed for LCI or LCA studies intended to support comparative studies that are intended to be published.
- VII) **SHALL - Impact coverage limitations (e.g. Carbon footprint):** Comparison studies based on selected indicators or impact categories (e.g. Carbon footprint based comparisons) shall highlight that the comparison is not suitable to identify environmental preferable alternatives, as it only covers the considered impact(s) (e.g. Climate change). This applies unless it can be sufficiently demonstrated that the compared alternatives do not differ in other relevant environmental impacts to a degree that would change the conclusions and/or recommendations of the comparison if those other impacts would be included in the analysis. Such demonstration should draw on robust approximations for the analysed system and/or robust information derived from detailed and complete LCA studies available for sufficiently similar systems. System / product group specific guidance document and Product Category Rules (PCR) may provide such robust information. The above shall be investigated in any case and if other environmental impacts were identified as being relevant in the above sense, they shall be named in the report. (6.10.8) [ISO!]

## Provisions: 6.10 Comparisons between systems

### For studies on systems with similar functional units:

Comparisons shall be made based on the system's reference flows.

- VIII) **SHALL - Functional equivalence:** The compared systems shall have the same (or only insignificantly different) functional unit in terms of both the primary function and possible secondary functions, as far as possible. In the case that some of the aspects of the functional unit(s) differ significantly between the systems, it shall be ensured that: (6.10.2)
- VIII.a) either the functions that the compared systems provide are still seen as sufficiently comparable by the main stakeholders affected by the LCA study,
- VIII.b) or the sufficient comparability is to be achieved by the respective method approaches for consequential modelling or attributional modelling<sup>109</sup>, as to be applied for the respective Situation (see chapter 6.5.4). For consequential modelling this approach is system expansion.
- IX) **SHOULD - Selection of compared alternatives:** The study should include - next to the foreseen alternatives - potentially environmentally better market relevant and available alternatives, as otherwise the study would be considered misleading. If such alternatives are not included, this shall later be highlighted in a prominent place of the conclusions and recommendations, as well as in the executive and technical summary chapters of the report, pointing to this fact. For studies on niche products, see chapter 5.2.2. (6.10.2) [ISO+]
- X) **SHOULD - Selection of production, operation and use scenarios:** To ensure a fair comparison, the chosen functional unit should reflect well-justified typical or average production / operation / use scenarios; it shall be agreed with the affected stakeholders in the best attainable consensus. If atypical or otherwise specific scenarios need to be compared in line with to the goal definition, compared, this fact shall later be highlighted in a prominent place of the conclusions and recommendations and executive summary chapter of the report, pointing to this fact. (6.10.2) [ISO!]
- XI) **SHOULD - Modelling replacements over time:** For cases where a system (e.g. a product) needs to be replaced to meet the required duration of performance of the compared functional unit, the replacement should consider that potentially a newer model or system in general will replace the initially used model. This is unless a different agreement can be achieved among the affected stakeholders. This provision analogously relates to the need of repeating a service.
- XII) **SHALL - Indicative only** (The exact and complete provisions are given in chapter 6.5.4.2). **Situation A - Assumption scenarios and uncertainty calculation:** For comparative micro-level studies (Situation A): each compared scenario shall be complemented with assumption scenarios of reasonably best and reasonably worst cases. This can be optionally extended to further assumption scenarios within the

<sup>109</sup> Comparisons also can occur in accounting type studies (e.g. across product groups in basket-of-product type of studies), while these shall not be used for decision support that would lead to e.g. purchases or policy measures based on superiority or inferiority of the compared alternatives.

### Provisions: 6.10 Comparisons between systems

reasonably best and worst cases. Uncertainty calculation shall be performed, unless such has already been used to derive the reasonably best and worst case scenarios. The interested parties shall be involved in achieving a best attainable consensus on the definition of the reasonably best and reasonably worst assumption scenarios. The assumption scenarios can in principle vary all methods, data and assumptions **except for** the "shall" provisions. (6.10.7)

XIII) SHALL - Indicative only (The exact and complete provisions are given in chapter 6.5.4.3). **Situation B - Assumption scenarios and uncertainty calculation:** For comparative meso/macro-level studies of Situation B: the scenarios for each of the analysed alternatives shall apply the modelling guidance of Situation A, except for process that are affected by large-scale consequences of the analysed decision. The assumption scenarios can in principle vary all methods, data and assumptions **including** the "shall" provisions, but excluding the shall provisions of ISO 14040 and 14044. (6.10.7)

XIV) SHALL - **Involvement of interested parties in review:** For their involvement in the critical review, see chapter 6.10 and separate guidance document on "Review schemes for LCA". [ISO!].

## 6.11 Identifying critical review needs

(Refers to ISO 14044:2006 chapter 4.2.8.3)

### Introduction

A critical review shall be performed by experts that have not been involved in the performance of the LCI/LCA study. This is generally beneficial for the quality and credibility and hence value of the study. This holds true also for exclusively in-house applications, even though in such cases there is no formal requirement for a critical review.

### Type of review and ILCD compliance

The required type of critical review (e.g. independent internal review, independent external review, (external) panel review, etc.), depends on the intended applications of the LCI/LCA study. In the ILCD Handbook this is defined in the separate document "Review schemes for LCA".

An accordingly performed review meeting the ILCD minimum requirements will automatically include conformity with ISO 14040 and 14044:2006 (and 14025 for Environmental Product Declarations (EPDs)). Note that certain LCA application schemes (such as e.g. Type I Ecolabel schemes) have own review requirements that have to be met as well.

The details on the review scope, methods and review documentation can be found in the separate document "Review scope, methods and documentation".

The minimum requirements on reviewer qualification are given in the separate document "Reviewer qualification". This qualification covers knowledge and experience in LCA methodology, in the review process, and in the analysed processes / sectors.



## Early decision on review

It is useful already during the scope definition to decide whether a critical review will be done, and if so which form of review and performed by whom (see chapter 11 and separate guidance document on review in LCA). This early decision will allow the data collection, documentation and reporting of the LCI/LCA study to be tailored to meet the requirements of the review, typically shortening and lowering the overall effort.

An early decision also allows running an inter-active concurrent review process. In a concurrent review the reviewers are given the opportunity to comment already on the goal and scope definition prior to the onset of the inventory analysis, and possibly on interim results of the impact assessment and interpretation before the reporting. This way their comments can guide the process of the LCA and can often prevent unpleasant surprises at the end of the project, e.g. additional data needs or even unsuitable comparisons that can set back a comparative assertion by many months. A concurrent review generally also further improves the credibility of the study.

For “Meso / macro-level decision support” LCAs (Situation B) the affected stakeholders shall be involved in deciding about the assumption scenarios. This can be done as part of the review; in this case, it is beneficial to start the review process from the onset of the study.

For the reference to the scope and methods of the review and its documentation, see chapter 11.

### Provisions: 6.11 Identifying critical review needs

Applicable to Situation A, B, and C, implicitly differentiated.

Fully applicable to all types of deliverables, implicitly differentiated.

- I) **SHALL - Review?:** Decide whether a critical review shall be performed and if so: [ISO!]
  - I.a) **Review type:** Decide along the provisions of the separate document “Review schemes for Life Cycle Assessment (LCA)” which type of review is to be performed as minimum.
 

Note that an accompanying review can be beneficial. For Situation B, it can moreover help to organise the best attainable consensus among interested parties, which is required for certain scope decisions (see provisions of chapter 6.5.4).
  - I.b) **Reviewer(s):** It is recommended to decide at this point who is/are the reviewer(s). The minimum requirements on reviewer qualification are given in the separate documents "Reviewer qualification".

Notes: An overview of the review requirements and the reference to the review scope methods and documentation requirements are given in chapter 11.

## 6.12 Planning reporting

(Refers to aspects of several ISO 14044:2006 chapters and relates to chapter 5)

### Introduction

Reporting is a vital element of any LCA. Without clear and effective documentation to experts and communication to decision makers, LCAs can be subject to erroneous and misleading use and will not contribute to improving environmental performance. Reporting shall be objective and transparent, and there should be a clear indication of what has and

what has not been included in the study and which conclusions and recommendations the outcome a comparative study supports and what now.

The form and levels of reporting depends primarily on three factors:

- the type of deliverable(s) of the study,
- the purpose and intended applications of the study and report, and
- the intended target audience (especially technical or non-technical and internal or third-party/public).

This ensures that the actually required documentation will be collected throughout the project.

Next to general purpose reports that will be sketched in this chapter and chapter 10.3, the various applications of LCA may have their own, specific form of reporting (e.g. Environmental Product Declarations (EPDs) or the reporting of indirect effects in Environmental Management reports of sites or companies, etc.). These will not be addressed in this document as they are out of the scope. Please refer to the respective application to identify the specific reporting needs.

### Forms of reporting

Three principally different forms of reporting are relevant that are often used also in combination (more details see chapter 10.3):

- a “classical” detailed project report, i.e. an often comprehensive text document typically with graphics and tables and that provides all relevant details e.g. on the analysed system(s) or developed LCIA methods, and the project in which the work was done. It is directed at LCA experts, but should contain an executive summary for non-technical audience. The full report provides detailed documentation about the system (or LCIA methods), their modelling, on assumptions and – especially in case of comparative assertions – on interpretation including conclusions and recommendations, if any. Confidential information can be foreseen to be documented in a separate, complementary report that is not published but only made available to the reviewers under confidentiality. If the detailed report is used for third party information, it shall contain a reference (preferably a hyperlink) where any related review reports can be easily accessed.
- a more condensed and formalised, electronically exchangeable report in form of a data set. A data set is suitable for documenting individual unit processes or systems (as Process data set) but not for documenting the outcome of comparisons. It is also suitable for LCIA methods (LCIA method data set). This form is also directed at LCA experts, mainly as data input for use in other LCA studies. As an electronic data set it allows other users importing the inventory and other technical details without manual transfer of values to their LCA software, i.e. limiting errors and directly using the inventory data (or impact factors) for modelling and analysing their own systems.
- a very condensed Executive Summary report of e.g. 1 to 2 pages that condenses the detailed project report to its essence in non-technical language. Note that this report is the one that should also be used in the detailed project report. If it is used as separate report for third-party information it shall contain a reference (preferably a hyperlink) where the detailed report and any related review reports can be easily accessed.

Whenever the final output type of the study is a data set or when data sets are developed and should stay available for subsequent uses, the most useful way of reporting is to combine a well documented Process data set or LCIA method data set (being a condensed

version of the detailed report) and the detailed report and any review reports as electronic attachment to that data set.

The ILCD Handbook comes along with an electronic template for LCA reports and with the ILCD reference format as an electronic data set format that both should be foreseen to be used (details see chapter 10).

### Levels of reporting

Three levels of reporting should be distinguished:

- reports or data sets for internal use,
- reports or data sets for external use (i.e. to be made available to a limited, well defined list of recipients with at least one organisation that has not participated in the LCI/LCA study), and
- comparative assertion reports that are foreseen to be made available to the (non-technical) public.

The different levels of reporting and the specific requirements for each of them are presented in chapter 10.3.

### Provisions: 6.12 Planning reporting

Applicable to Situation A, B, and C, implicitly differentiated.

Fully applicable to all types of deliverables, differentiated.

I) **SHALL** - Reflecting on the main type of deliverable (i.e. study or data set) and in line with the decision on the target audience(s) and intended application(s) (see chapter 5.2), decide on form and level of reporting:

I.a) **Form of reporting:** Decide which form(s) of reporting shall be used to meet the need of the intended application(s) and target audience(s): [ISO!]

I.a.i) detailed report (including non-technical executive summary),

I.a.ii) data set,

I.a.iii) data set plus detailed report, or

I.a.iv) non-technical executive summary (with references to the full report and review reports, if review has been performed).

I.a.v) The electronic ILCD LCA report template and LCI data set format should be foreseen to be used for reporting.

Confidential information can be documented in a separate, complementary report that is not published but only made available to the reviewers under confidentiality.

Note that any form of reporting, also more condensed ones, shall ensure that the contained information cannot easily and unintentionally be misunderstood or misinterpreted beyond what is supported by the study.

I.b) **Level of reporting:** Decide which level of reporting shall be used in accordance with the defined goal. The main levels are:

I.b.i) internal

I.b.ii) external (but limited, well defined recipients)

I.b.iii) third-party report, publicly accessible

I.b.iv) report on comparisons, publicly accessible

For the detailed reporting requirements see chapter 10.

# 7 Life Cycle Inventory analysis - collecting data, modelling the system, calculating results

(Refers to ISO 14044:2006 chapter 4.3)

## 7.1 Introduction and overview

(Refers to ISO 14044:2006 chapter 4.3.1 and 4.3.2.3 and other aspects of ISO 14044:2006 chapter 4.3)

### Introduction

During the life cycle inventory phase the actual data collection and modelling of the system (e.g. product) is to be done. This is to be done in line with the goal definition and meeting the requirements derived in the scope phase. The LCI results are the input to the subsequent LCIA phase. The results of the LCI work also provide feedback to the scope phase as initial scope settings often needs adjustments.

Typically, the LCI phase requires the highest efforts and resources of an LCA: for data collection, acquisition, and modelling.

Note the limitation of the scope of the LCA approach: it relates exclusively to impacts that are potentially caused by interventions between the analysed system and the ecosphere, and caused during normal and abnormal operating conditions of the included processes, but excluding accidents, spills, and the like. See the related information in chapter 6.8.2.

If non-LCA effects are analysed, they must be inventoried, aggregated and interpreted separately from the life cycle inventory. This document is not explicitly providing guidance on these. While it may help to ensure taking a consistent approach, dedicated guidance and tools should be consulted or used.

### Overview

The first steps of the LCI work further detail and concretize the requirements derived in the scope phase, e.g. on specific data sources to be used, planning data collection, etc. The requirements themselves are however always to be understood to be a scope issue.

The inventory phase involves the collection of the required data for ...

- Flows to and from processes:
  - Elementary flows<sup>110</sup> (such as resources and emissions but also other interventions with the ecosphere such as land use),
  - Product flows (i.e. goods and services both as "product" of a process and as input/consumables) that link the analysed process with other processes, and
  - Waste flows (both wastewater and solid/liquid wastes) that need to be linked with waste management processes to ensure a complete modelling of the related efforts and environmental impacts.
- Other information identified in the scope definition as relevant for the analysed system. This includes statistical data (e.g. market mix data), process and product characteristics

---

<sup>110</sup> The ILCD reference elementary flows should be used wherever possible and relevant, ensuring compatible inventories and avoiding multiple occurrences of the same flows in joint/aggregated inventories, when combining data sets from different sources.

(e.g. functions and functional units), and all other data and information, except for those directly related to impact assessment.

The specific kind of life cycle inventory work depends on the deliverable of the study; not all of the following steps are required for all of these. In its entirety, life cycle inventory work means:

- Identifying the processes that are required for the system (7.2.3 for attributional and 7.2.4 for consequential modelling),
- Planning of the collection of the raw data and information, and of data sets from secondary sources (7.3)
- Collecting (typically) for the foreground system unit process inventory data for these processes (7.4). An important aspect is the interim quality control and how to deal with missing inventory data (7.4.2.11)
- Developing generic LCI data, especially where average or specific data are not available and cannot be developed, typically due to restrictions in data access or budget (7.5)
- Obtaining complementary background data as unit process or LCI result data sets from data providers (7.6),
- Averaging LCI data across process or products, including for developing production, supply and consumption mixes (7.7)
- Modelling the system by connecting and scaling the data sets correctly, so that the system is providing its functional unit (7.8).
- This modelling includes solving multifunctionality of processes in the system. For this step see 7.9 for attributional modelling and – given the different modelling logic - chapter 7.2.4.6 for consequential modelling where this is integral part of the identification of included processes.
- Calculating LCI results, i.e. summing up all inputs and outputs of all processes within the system boundaries. If entirely modelled, only the reference flow (“final product”) and elementary flows remain in the inventory (7.10).

These steps are done in an iterative procedure, as explained in chapter 4 and illustrated in Figure 4 and Figure 5.

## 7.2 Identifying processes within the system boundaries

(Refers to aspects of ISO 14044:2006 chapters 4.2.3.3.2 and 4.3.2.1)

### 7.2.1 Introduction and overview

(Refers to aspects of ISO 14044:2006 chapters 4.2.3.3.2 and 4.3.2.1)

If the LCI/LCA study goes beyond the analysis and modelling of a single unit process and is to deliver e.g. an LCI results data set or a product comparison report, the whole system is to be analysed: For all life cycle stages included in the system boundaries those processes are identified that must be covered by the later data collection.

The way how processes are identified within the system boundaries differs considerably between attributional and consequential modelling. Different processes and data are accordingly required based on the modelling approach; chapters 7.2.3 and 7.2.4 provide the detailed procedures to identify them.

It is reiterated here what was already stressed in the scope chapter on system boundary setting and what applies to both attributional and consequential modelling: Types of activities that are generally to be included in LCA are all activities under normal and abnormal operating conditions that are related to the analysed system, while not accidents, spills and the like. The system boundary of LCA includes hence for example mining, processing, manufacturing, use, repair and maintenance processes as well as transport, waste treatment and other purchased services such as e.g. cleaning and legal services, marketing, production and decommissioning of capital goods, operation of premises such as retail, storage, administration offices, staff commuting, business travel, etc. In short: all non-accident activities that are carried out in relationship to the analysed system and that can either be attributed (attributional modelling) to it or expected/modelled to be a consequence of a decision in the foreground of the analysed system (consequential modelling) should be included unless they are quantitatively not relevant, applying the cut-off criteria. Any other omissions shall be documented and considered in the interpretation.

## 7.2.2 Part-system and system-system relationships

A special topic are part-system relationships and system-system relationships that relate to both attributional and consequential modelling and that effectively need the same modelling solution. The related boxes below explain the concepts:

### **Terms and concepts: Part-system relationships including energy related products**

A part-system relationship refers to a subsystem that is regular part of another system and contributes to its function(s). It can be challenging to correctly model the life cycle of such relationships (both typically being goods, e.g. a starter battery as part of a car; a water-saving shower head as part of a shower; a window as part of a building, etc.): the technical interaction between the analysed part and the full system and its other parts/components is typically to be explicitly considered in the system boundary definition. This is unless the goal and the scope of the study requires or at least permits to look at the part in isolation. The relationship shall be taken into account if the part would be compared with other parts with somewhat different interaction with the system or if analysing improvement options. This applies also for attributional modelling, as the part alone cannot perform its ultimate function in isolation, e.g. in time series monitoring of the part with the different models having a different interaction with their systems. If the part can be modelled in isolation and the data and/or report (e.g. an EPD) will be made available externally, the necessity to include the part-system relationship in further uses of the data (e.g. for comparative studies etc.) should be explicitly documented nevertheless.

E.g. will different car starter batteries of a substantial different weight result in e.g. a changed battery mount, wiring, etc. The resulting different total weight of the car will also affect the acceleration properties of the car. The car therefore needs to be modelled with an accordingly differently sized engine, to keep the comparability of the functional unit of the two car variants. Figure 17 illustrates this.

In the mentioned example of the water-saving shower head, the lower water flow allows to save water and energy while still delivering a comparable functional unit. Hence the amount of water and energy consumed in the use stage is to be considered when comparing the use of different shower heads. Depending on the exact goal of the LCI/LCA study (e.g. use of the water-saver for new homes only, or replacement in existing homes) also the potentially smaller water heater installed needs to be considered. This results in the need for different scenarios and hence different processes to be included in the system boundaries. Such

energy related products require a clear definition of the relationship and the reality, measurability / quantifiability of the effect.

Also intended interactions between processes can be understood as cases of part-system relationships: e.g. a servicing process that is affecting the serviced good and changes its performance (e.g. low friction motor oil), life time (e.g. maintenance and repair processes in general or e.g. differently aggressive cleaning agents), or that causes specific emissions (e.g. Chromium solving / abrasion by aggressive cleaning agents).

In the earlier example of windows, their performance can only be compared in the context of the whole building, as the building's heating (and/or cooling) system, solar gains that depend on the window area and orientation, and other aspects must be included for correctly assessing the windows' use stage. As said earlier, LCI data of the window itself can still be developed and made available but their use in decision support must be done from a system's perspective.

These examples illustrate again that a good technical understanding of the analysed product/part and related systems is an essential pre-requisite for performing a valid LCA, and in an even higher degree for studies that involve part-system relationships.

See also the next box for system-system relationships.

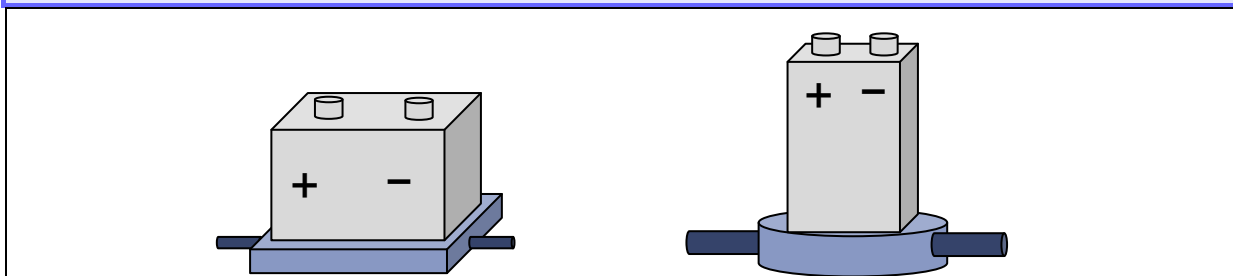

**Figure 17 Part-system relationships: example of car starter battery for a comparative study or time-series monitoring that cannot be analysed in isolation, as different battery variants (grey) require different e.g. mounts and other parts (blue) and result in different fuel use during the use stage. If they are substantially different in weight this results even in different engine sizes to not change the car (=system) performance, what needs to be considered as well.**

An apparently similar case to part-system relationships are system-system relationships; the below box explains them and the implications for identifying processes and modelling the system.

### Terms and concepts: System-system relationships

System-system relationships refer to the use of the "analysed system" (e.g. product) in context of one or more, other, generally independent systems (called hereafter "context system"). I.e. the analysed system is not regular part of the context system and does not contribute to its function(s) but has primarily other, distinct functions. However, the analysed system is affecting the context system via a co-function, generated waste (e.g. waste heat), or specific emissions<sup>111</sup>. It may thereby modify the context systems performance and functions. System-system relationships can hence methodologically be a special case of multifunctionality of processes or products. In other cases, the context system "treats" the

<sup>111</sup> As these "emissions" are emitted inside the technosphere, i.e. the context system, they are formally no emissions but equivalent to untreated emissions such as raw gas or raw wastewater. For simplicity they are nevertheless called emissions here, looking at them from the perspective of the analysed system.



emission before it leaves the technosphere. The use of e.g. computer or a coffee machine as analysed system in an office building as context system are examples, with heat as a co-product (during the cold season) and a waste (in the warm season). Note that both systems can be usefully operated also fully independently, other than in part-system relationships. The analysed system and the context system can interact in two different ways that require different modelling:

In one case, one or more secondary functions of the analysed system cause changes in the operation of the context system (e.g. for the above examples the heat generated by the analysed computer results in less need for heating of the building and/or more need for cooling - i.e. treating the waste heat - depending on season and country).

This case is methodologically very similar to the specific short-term marginal consequence known in consequential modelling (see chapter 7.2.4.4) and modelled accordingly; this will be detailed in the respective chapter. The main difference is that the consequence here acts directly and not via a market mechanism.

In attributional modelling, the co-function (e.g. heat during the cold season) needs to be allocated, applying the 2-step allocation procedure of chapter 7.9.3. For the warm season, when the co-generated heat is in fact a waste heat and cannot be considered a valuable co-product that would call for an allocation, the de-facto operated waste heat treatment process "air conditioner" is to be modelled within the system boundary<sup>112</sup>.

In another case, the same secondary functions may in addition to changing the operation of the context system also alter it, e.g. the installed machines or other goods used to operate in the context system. This is the case if the operation of the analysed system is considered in the planning of the context system: E.g. the installed capacity of the building's heating and/or cooling equipment may be different in the above example, if the heat production of the computer is considered when planning the office building.

For attributional modelling this case is of relevance if future data is modelled attributionally (e.g. for extrapolating accounting data for future years) and the context system is modelled either considering the effect of the analysed system or not. Note that this is however not a methodological issue of modelling consequences, but of forecasting system planning.

For consequential modelling this is methodologically equivalent to the specific long-term marginal, except that the change in installed capacity is not caused due to the size of the effect in the market, but due to the specific and close micro-level system-system relationship when planning the context system. It is applicable if the secondary consequences are explicitly considered in the planning of the context system.

Which of the two cases applies depends on the question whether the secondary functions, waste and emissions have been considered when designing the context system.

System-system relationships hence play a role in solving multifunctionality of processes and products and are addressed again in the respective chapters, providing the specific provisions.

---

<sup>112</sup> Note that this is not system expansion.

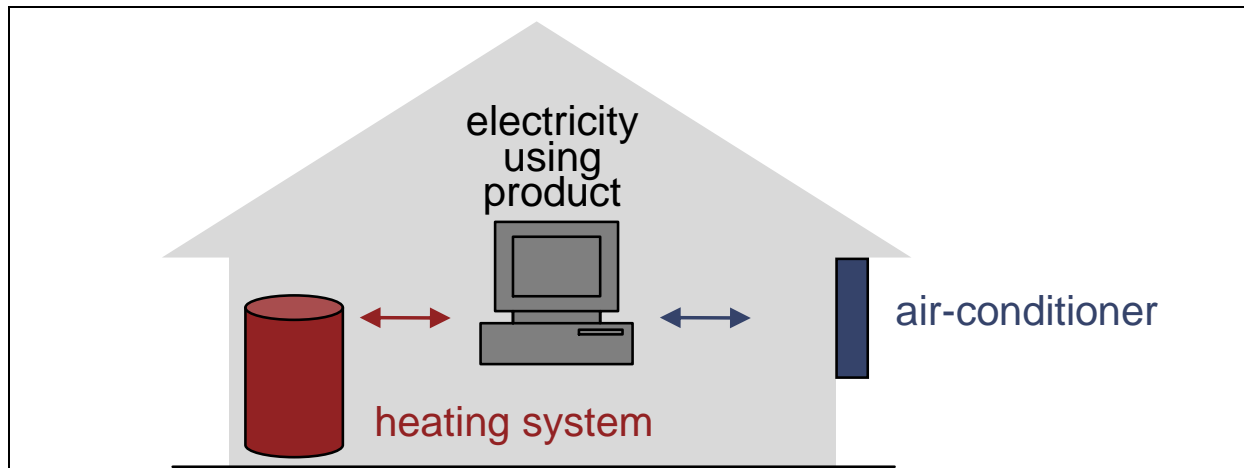

**Figure 18 System-system relationships: example of an electricity using product (e.g. computer, coffee machine, fridge, etc.) as analysed system that is operated within a context system (here: a private home). Due to its secondary product "heat" it is lowering the need for heating in the cold season / high latitudes. At the same time is this "waste heat" increasing the demand for air conditioning in the warm season / tropical climates.**

Provisions that relate to part-system and system-system relationships are addressed in several chapters that provide LCI modelling provisions, drawing on the concepts detailed here.

## 7.2.3 Identifying processes in attributional modelling

(Refers to aspects of ISO 14044:2006 chapters 4.2.3.3.2 and 4.3.2.1)

### 7.2.3.1 Introduction and overview

(Refers to aspects of ISO 14044:2006 chapters 4.2.3.3.2 and 4.3.2.1)

Attributional modelling depicts the system as it can be observed/measured, linking the single processes within the technosphere along the flow of matter, energy, and services (i.e. the existing<sup>113</sup> supply-chain) (see Figure 19 and see again the box in chapter 6.5.2).

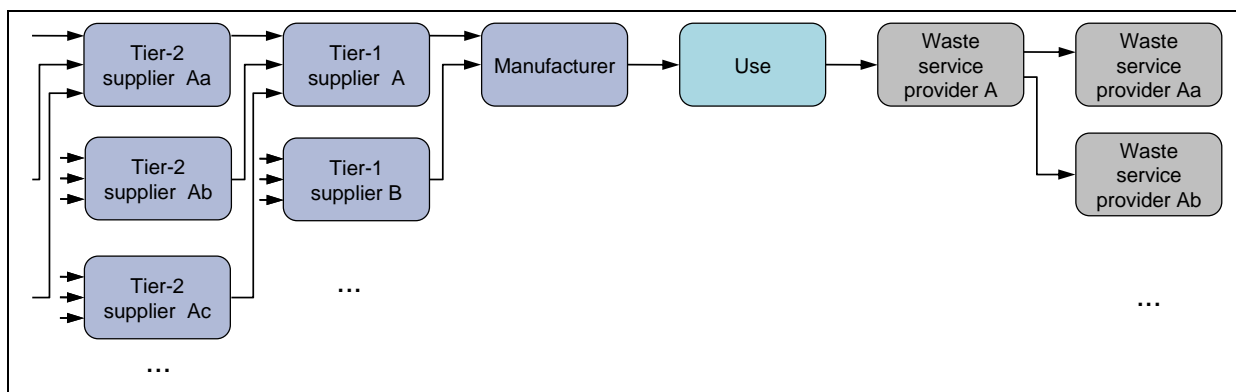

**Figure 19 Schematic and simplified supply-chain life cycle model of a product. The system model is depicting the actual supply chain of production, the product use, and the waste management chain. Not shown in the graphic are the waste management processes for production waste, recycling, as well as transport and other e.g. service processes that are included identically as in the real supply-chain.**

<sup>113</sup> In the case of extrapolation or scenario modelling this can also be the future supply-chain.

This step of “attribution” is crucial, but only implicitly addressed in ISO. Different approaches have accordingly developed in practice, resulting in inconsistent system boundaries, models, and final results.

The following subchapters provide a stepwise guidance for identifying the processes that are to be attributed to the analysed system under attributional modelling.

The questions whether to rather collect specific data or to obtain average or generic data sets and whether to work with unit process data or with LCI results are addressed in chapter 7.3.

### 7.2.3.2 Processes to be attributed to the analysed system

(Refers to aspects of ISO 14044:2006 chapters 4.2.3.3.2 and 4.3.2.1)

#### Introduction and overview

The following text guides to a reproducible identification of processes that are to be included in the system boundaries.

As a starting point it is good to remember that attributional modelling aims at depicting the reality of the analysed system's processes and life cycle stages (as far as required for the analysed system) in analogy to the supply-chain, use stage, and end-of-life: accordingly, any process that physically handles the analysed product (system) and the goods and services that are physically used to produce it or that causes costs for the production, use, or waste treatment is likely part of the system boundaries.

For the production of goods and provision of services as well the waste and end-of-life treatment, the identification of to-be-attributed processes is therefore rather straightforward. For the use stage by final consumers additional criteria have to be used. In practice however this straightforwardness seems not always to result in an appropriate identification of the required processes. Guidance is hence required.

Conceptually this guidance starts from the system's functional unit or reference flow (i.e. starting from the central process of the foreground system) to systematically check for to-be-included processes in the entire foreground system. It then follows a descriptive "supply-chain - use - end-of-life" logic to identify all those product and waste flows (or their functional units) that cross the border to or from the background system. All processes that this way can be attributed and quantitatively related to that process are to be identified and quantified. The technical process flow diagrams for the processes of the foreground system that were initially available or have been developed or expanded during the following procedure help during the inventory data collection, interim quality control, and - if foreseen - third-party review.

During the work it is recommended to document the identified processes of the foreground system and the links to the background system in a flow-chart type diagram for each analysed system. This flow chart might be developed starting from the initial one made when defining the system boundary and can serve as starting point for the sub-subsequent planning of the data collection. The final version of that flow-chart may also be added to the documentation in the final data set or report.

Note also that in practice there is no need to identify the further next indirect levels for an analysed process if

- the identified and to be included process is part of the background system, and
- a sufficiently good quality LCI data set for this process and its further (upstream or downstream) life cycle is available from former studies or can be obtained from third-party data providers.

## Identifying the processes

Looking at the identification in a more functional/technical perspective, the following levels of processes should in principle<sup>114</sup> be attributed to the analysed process or system, starting from the system's functional unit or reference flow, i.e. its central process at level 0. Note that the steps below are no strict and exact, complete requirement, but help in structuring the process of identifying the to-be-included processes for which data is required (see also Figure 20):

### Level 0 - central process or analysed system

- On level<sup>115</sup> 0 stands that process of the foreground system that directly provides the analysed functional unit(s) or reference flow(s) as its function: E.g. an “injection moulding machine<sup>116</sup>” that produces a plastic part as a good, a “truck” that is used to provide a transport service as its function, a “field” that grows wheat and straw as goods, a “light bulb” that is used to provide light as a service, a “waste incineration oven” that treats waste as a service, a “vacuum cleaner” that is used to provide a carpet cleaning service in private homes, etc. Note that some of these processes are goods, while others are services or product-service systems. Some processes may physically be perceived as persons<sup>117</sup> (e.g. a “painter<sup>118</sup>” that paints a façade). Also the use-phase of products is covered by this level. Note that the same applies when working with generic processes that combine properties of one or more processes. The same applies analogously in case wider systems are analysed (e.g. an event, the individual mobility of the citizen of a whole country, or the total governmental consumption within a country as accounting indicators): The difference is that more than one level 0 process is to be identified that together provide the system's functional unit.

### Level 1 – physical embodiment in the good<sup>119</sup>

- On level 1 stand those goods that (partly or fully) physically end up in the analysed good or other goods that are part of the system: Expanding on the initial examples, these are e.g. the “LPPE polymer” that enters the injection moulding machine that produces the before-mentioned plastic part, or the “N-P-K fertiliser” that partly end ups in the wheat plants cropped on the field. Other examples: specific “stainless steel parts” that are assembled to form a complex product, “benzene” and “chlorine” that enter a

<sup>114</sup> Note that in practice, the relevance of the various processes for the overall environmental impact of the analysed system differs widely. Typically only a quite limited number of processes and flows actually contribute to a relevant degree to the overall impact. The application of cut-off rules along with expert judgement helps in effectively and efficiently identifying the actually relevant processes to be attributed.

<sup>115</sup> Note that these levels are used as simple, pragmatic guidance and that the exact definition of the levels can be done somewhat differently, depending on the level of the process (i.e. black box or single operation) one looks at. This does not affect the applicability of the guidance as the levels only serve for rough orientation.

<sup>116</sup> Note that e.g. a “machine” is no process, but the process is the operation of the machine. For simplicity and clarity the used equipment or other kind of system that is performing the process is used synonymously for the process of the level.

<sup>117</sup> Note that by commonly applied convention the processes that meet the general individual needs of such persons (e.g. food, housing etc.) that e.g. as workers contribute to the production of goods etc. are NOT to be included into the analysed product system. In the cases of physically heavy human work as part of an analysed product system, the additional need for calories should however be included, if relevant according to the cut-off criteria.

<sup>118</sup> Strictly the “brush” is the good performing the “painting” process, but this would be rather confusing.

<sup>119</sup> This step is not applicable to analysed services.

reactor that produces various chlorinated benzenes as co-products, the "paint" that is used to paint the façade, etc.

### Level 2 – contact with the central process or analysed good

- On level 2 stand those goods and services that only handle or touch the good or level 0 process by performing a supporting function that supports the provision of the analysed function: E.g. auxiliary materials such as "form oil" to release the injection moulded plastic part, "diesel", "grease" and other consumables that are needed to operate the truck, "pesticides" that help that the wheat is achieving its yield, "electricity" that operates the lamp but also its "lamp-holder" and "fixings" and the "light bulb packaging", supplementary "fuels" to ensure the necessary waste incineration temperature is reached, "light" and "heat" that are provided in the manufacturing line so the workers can assemble the complex product as well as the "hall" of the line that protects against the weather, "packaging materials" of the vacuum cleaner and the paint, "catalysts" that support the production of the chlorinated benzenes. Other examples: "detergents" and "hot water" used for a floor cleaning process, "solvents" that are used in the paint that is applied in a paint shop, etc. These level 2 processes include part-system relationships that need special attention; see the related box in chapter 7.2.2.

### Level 3 – services for the central process or system

- On level 3 we find those processes that do not even touch the analysed process' equipment or analysed good or would provide a direct function for the provision of a service, but that are required to nevertheless run in the background in relationship to the process. Examples are administration, guarding, marketing and legal services, etc.

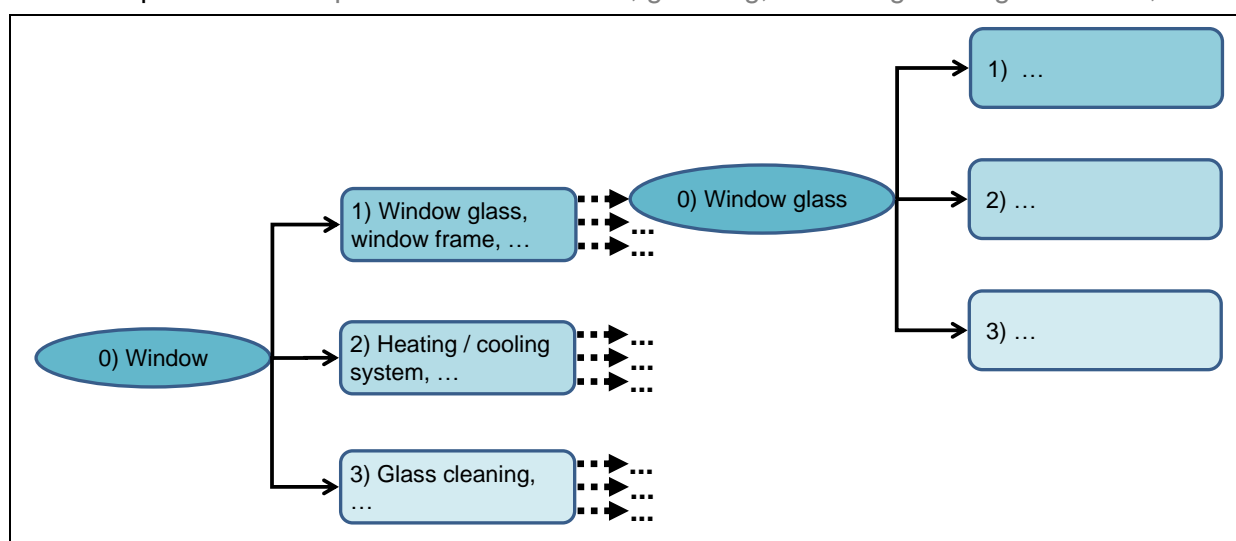

**Figure 20** Identifying processes within system boundary, starting from the central process or analysed system. Example of a window, illustrative: The window is the analysed system and hence set as level 0 (oval to the left). After having identified the processes at the levels 1 to 3, each of them becomes a new level 0 process (here shown: "window glass" as oval in the middle). The related processes on the levels 1 to 3 are identified for each of the new level 0 processes, and so on.

### Indirect processes beyond level 3

- Beyond that level 3 we come to surrounding processes that in fact do not relate directly to the central process or system that we look at but to those processes that were identified in the levels 1 to 3. These indirect processes are identified by now looking at

each of the processes that were identified as level 1 to 3 and that are part for the foreground system (or connect the foreground with the background system), applying the same logic of the levels 0 to 3 (see also Figure 20). This is repeated again for the next level processes identified in this way and so on. Note that this does not result in an endless list of processes to be included, as by applying cut-off rules - drawing on experience for similar processes and expert judgement - by far most of these can be excluded. (On applying cut-off rules see chapters 7.4.2.11 and 9.3.2). Examples of such processes that only indirectly via other processes relate to the initially analysed level 0 process are e.g. the “production”, “maintenance”, “repair”, etc. of any of the above equipments such as of the injection moulding machine, light bulb, truck, hall, reactor, etc. Other examples are the “tractors” that distribute the named fertilisers and pesticides to the field. Beyond these, we find “R&D” of the equipment and processes, “corporate legal services”, “corporate marketing activities”, “business trips”, “staff commuting”, etc.

### **Frequent errors: General or un-reflected exclusion of activity-types**

As already addressed in chapter 6.6.2, in LCA practice it can still often be found that certain types of activities that should be attributed to the analysed system are omitted without sufficient justification. Among these processes, services and investment goods are the most common ones. While it might be justified to e.g. ignore the construction and demolishing of the power plant itself when modelling electricity production (depending of course on the cut-off criteria set), the limited relevance of investment goods certainly does not apply in general. Similarly, are many services in many cases of limited quantitative relevance, but also this can clearly not be generalised. A good example is the wind-power plant, where the plant production and maintenance make up the vast majority of impacts.

It is to be checked for the given case along approximations and drawing on former experience, which product and waste flows and which processes can be excluded in line with the cut-off criteria and which not. Chapters 7.4.2.11 and 9.3.2 provide the respective guidance for unit processes, chapter 7.8 for systems. This cannot be done on the general level “type of activity”, unless quantitatively justified.

### 7.2.3.3 Initial description of identified processes

(Refers to aspects of ISO 14044:2006 chapters 4.2.3.3.2)

Especially for the processes of the foreground system, an initial description is required. This will be revised when collecting and documenting the unit process data. Details on documentation are given in chapter 10.

Unless the deliverable of the LCA is a unit process data set: For those product flows that connect the foreground system with the background system, a detailed specification including of their function and functional unit is required.

#### **Provisions: 7.2.3 Identifying processes in attributional modelling**

Applicable to Situation A and C, as well as the life cycle model(s) of Situation B, except for those process steps that are affected by large-scale consequences. Also applicable to the assumption scenarios under Situation B for which it has been decided to apply attributional modelling.

Fully applicable for LCI results, partly terminated systems, LCIA results, and LCA studies (and for unit processes only to complete the system model for completeness check and precision approximation).

For black box unit processes as deliverable, only those processes that are foreseen to be included are to be

### Provisions: 7.2.3 Identifying processes in attributional modelling

identified, as are the product and waste flows that enter or leave the unit process.

For single operation unit processes only the product and waste flows that enter or leave the unit process are to be identified and specified; the named technical flow diagram in that case only consists of one process plus product and waste flows.

- I) **SHALL - Identifying processes within the system boundary:** All quantitatively relevant processes shall be identified that are to be attributed to the analysed system(s) and that lay within the system boundary: [ISO+]
  - I.a) **Start from central process:** This identification should start from the system's functional unit or the reference flow (i.e. from the central process of the foreground system or the analysed system itself). (7.2.3.2)
  - I.b) **Foreground system:** Stepwise it should be expanded to the entire foreground system. Following a descriptive "supply-chain - use - end-of-life" logic it shall as far as possible identify all relevant product and waste flows (or their functional units) that cross the border to or from the background system. (7.2.3.2)
  - I.c) **Background system:** The processes in the background system shall be identified in the same "supply-chain - use - end-of-life" logic as applied in the foreground system. A recommended systematic procedure for identification is detailed in the main text of the chapter. (7.2.3.2)

Note that it is established practice to embed the foreground system into a third-party or in-house developed general background system of LCI results and/or unit processes. That means that in practice the identification described above ends with the identification of the product and waste flows that connect the foreground system with the background system. Systems or processes that would be missing in such a general background system are for a given case collected or obtained from third parties as required for the analysed system.

- I.d) **Justify and document exclusions:** Any exclusion of relevant individual processes or activity types shall be justified using the cut-off criteria (as defined in chapter 6.6.3). This can build on previous experience including as detailed in related system / product-group specific guidance documents or Product Category Rules (PCRs). The systematic check is described jointly with the same procedure for unit process interim quality control and application of cut-off criteria in chapters 7.4.2.11 and 9.3.2, respectively. In principle all processes are to be inventoried that are to be attributed to the system, as far as they relevantly contribute to the overall environmental impact of the analysed system. This includes in principle - depending on the included life cycle stages and the system boundary in general - activities such as e.g. mining, processing, manufacturing, use, repair and maintenance, transport, waste treatment and other purchased services linked to the analysed system, such as e.g. cleaning and legal services, marketing, production and decommissioning of capital goods, operation of premises such as retail, storage, administration offices, staff commuting and business travel, etc. (7.2.3.2)
- I.e) **Part-system and system-system relationships:** Part-system and system-system relationships need special attention (e.g. for energy related products) and correct inventorying (concepts see chapter 7.2.2.). (7.2.3.2)
- I.f) **Technical flow diagram, lists of product as and waste from/to background system:** It is recommended using the system boundary scheme for overview. Technical flow diagrams of the foreground system and lists of the products and

### Provisions: 7.2.3 Identifying processes in attributional modelling

waste that link the foreground with the background system may be used to document the main resource bases, trade-partner countries for consumption mix data and production routes, etc. This can form the basis for the data collection planning and the starting point for later documentation. (7.2.3.1)

Note that individual processes within the background system may need to be identified as well - in context of identifying sensitive issues (see 9.2) or if required to meet the specific goal of the study.

The requirements regarding technological, geographical and time-related representativeness of the scope chapter 6.8 shall be met. (7.2.3.2)

Note that the resulting initial list of processes, product and waste flows typically will need a refinement in view of the results of the completed initial life cycle model, impact assessment and interpretation.

- II) **SHALL - Initial processes' description:** It is recommended to provide an initial description of the identified unit processes of the foreground system, as well as the details of the functional units of those product and waste flows that link it to the background system. This should be updated in the iterative steps of LCI work and shall reflect in the end the final unit processes of the foreground system. (7.2.3.3)

## 7.2.4 Identifying processes in consequential modelling

(Refers to aspects of ISO 14044:2006 chapters 4.2.3.3.2, 4.2.3.6.2, and 4.3.2.1)

### 7.2.4.1 Introduction and overview

(Refers to aspects of ISO 14044:2006 chapters 4.2.3.3.2, 4.2.3.6.2, and 4.3.2.1)

#### Introduction

If the modelling approach is consequential, the relevant consequences and the related processes are to be identified as detailed below. This is relevant exclusively for cases of multifunctionality in Situations A, B and C1, for processes that are affected by "big" changes (large-scale consequences) in Situation B, and for the "assumption scenarios" in Situation B, in case these include consequential modelling. While this chapter describes the consequential approach in detail, **note that some key simplifications are made in the provisions for Situations A, B, and C1** that render the work substantially simpler without relevantly changing the robustness of the results (see chapter 6.5.4). Exclusively for processes that are affected by "big" changes (large-scale consequences) in Situation B and in the assumption scenarios of Situation B this chapter is required to be applied in its detail.

The "consequential" LCI modelling framework aims at identifying the consequences of a decision in the foreground system on other processes and systems of the economy and builds the to-be-analysed system around these consequences.

One important aspect of consequential modelling is that it is not depicting the actual processes of e.g. the suppliers of a specific product supply-chain as an attributional model does, but it is modelling the forecasted consequences of decisions. These consequences are those processes that are assumed to be operated as reaction to the named decision. In unconstrained and fully informed markets they will in general be those processes that most cost-effectively provide the required function (and the processes that a co-function would supersede). However, unconstrained and fully informed markets are a theoretical, ideal case. In practice other aspects need to be considered.



## Primary and secondary consequences, constraints

A wide range of mechanisms is discussed among LCA practitioners, how a decision in the foreground system affects other processes and products and what are the primary and secondary consequences (the concept of secondary consequences is explained in chapter 7.2.4.2). These mechanisms range from causing the need to build new production plants in consequence of additionally required materials, parts etc., to market displacement of competing products due to marginal market price changes, consumer behaviour changes, and the like. However, next to far reaching consequences, often secondary consequences and constraints counteract and partly or fully compensate the primary consequences or change them to other consequences. Among these are e.g. the economy's elasticity, the counteracting changes in the demand for the analysed product, reduced consumption of additional required products in other systems due to market-price changes, and many other secondary consequences (e.g. so called "rebound effects") as well as contractual, political and other constraints.

### Required expertise

To identify the detailed consequences and marginal processes, next to LCA expertise the following expertise is required, while this depends on which of the mechanisms and models are to be considered in the consequential model:

- expertise of technology development forecasting (learning curves, experience curves),
- scenario development,
- market cost and market forecasting,
- technology cost modelling,
- general-equilibrium modelling, and
- partial-equilibrium modelling.

### Overview

The following subchapters explain the steps towards modelling the consequences for the consequential model:

- The first step towards identifying the marginal processes that provide the function and the superseded processes is to identify / decide which primary and secondary consequences and constraints are to be integrated in the model. (chapter 7.2.4.2).
- Next is the identification of the processes that are operated or displaced due to the identified consequences (chapter 7.2.4.4).
- Analysing the considered consequences and taking into account the selected constraints, the processes are identified and the consequential life cycle is modelled stepwise. This starts from the analysed decision in the foreground system.

Figure 21 provides a schematic overview of the provisions on identifying processes in consequential modelling; but note the simplified provisions set for Situation A and B in chapters 6.5.4.2 and 6.5.4.3.

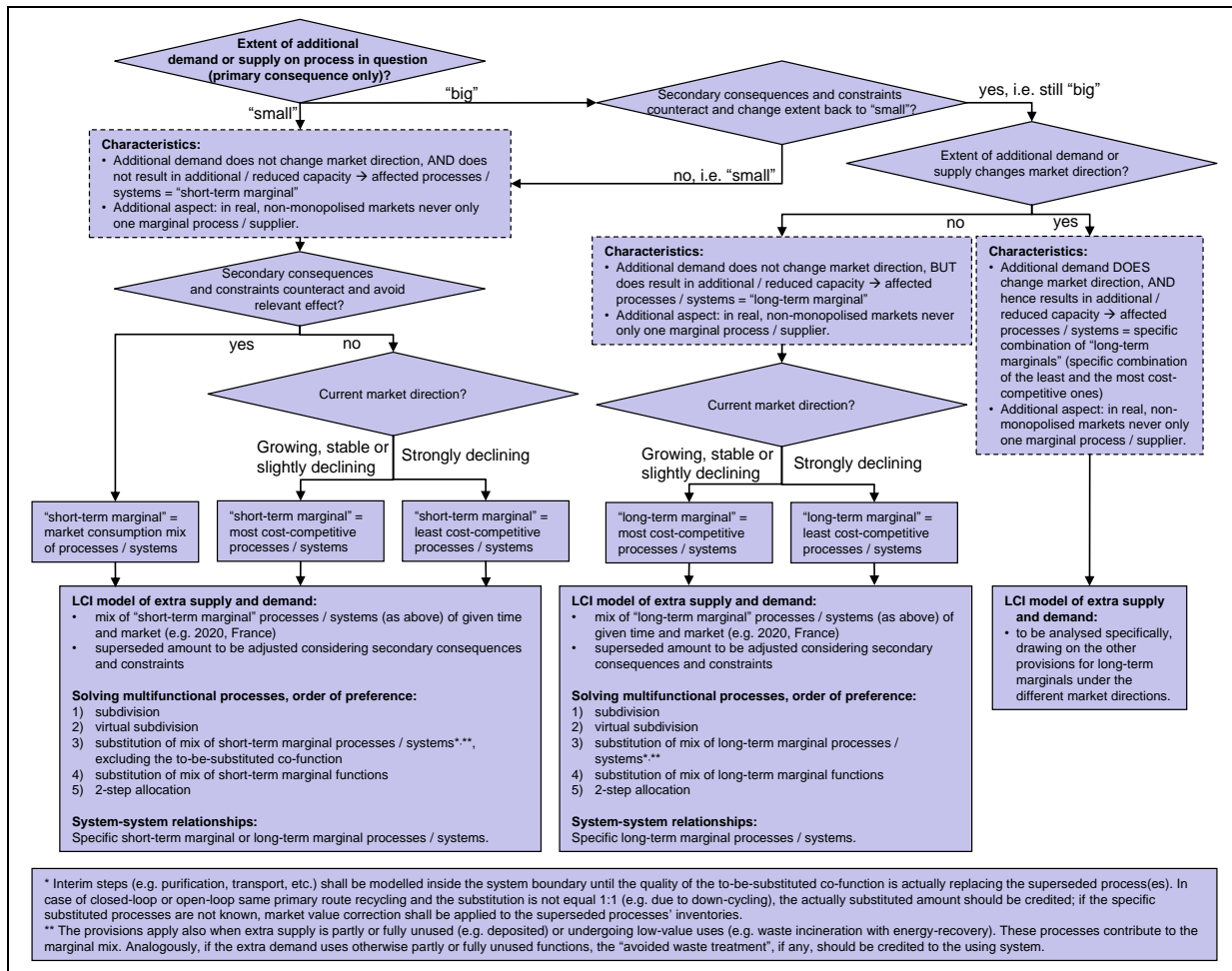

**Figure 21 Decision tree for consequential modelling<sup>120</sup>. Terms, concepts, and explanations see text. Formal and detailed provisions see "Provisions".**

The collection of the individual unit process data is in principle the same as for attributional modelling and addressed jointly in chapter 7.3.

The use of average and generic background data is addressed separately in chapter 7.6.

### 7.2.4.2 Consequences to be considered

(No corresponding ISO 14044:2006 chapter but relates to aspects of chapters 4.2.3.3.2, 4.2.3.6.2, and 4.3.2.1)

Wherever in practice consequential modelling is to be applied, the relevant consequences to be considered are to be decided upon.

Central in a consequential modelling is a quantitative understanding of the market and how direct and indirect changes in supply and demand of the analysed good or service operate through the market to cause real changes in demand and supply of other goods and services.

The range of questions that can be put to consequential LCA studies is vast and these can explicitly or implicitly require including a huge variety of consequences. There is no possibility to identify this in a generally applicable, generic way. It is hence to be decided for the given case.

<sup>120</sup> Note that the specific provisions for Situation A and B use some simplifications, as detailed in chapters 6.5.4.2 and 6.5.4.3.

Notwithstanding this but providing basic guidance on this question, the following provisions are made:

**The following primary consequences should be evaluated for inclusion (unless they are in any case already explicitly required or directly derived from the specific goal of the study):**

- (a) Processes that are operated as direct market consequence of the decision to meet the additional demand of a product (i.e. “consequential modelling of direct consequences; applied for the full system”).
- (b) Processes that supersede / complement co-functions of multifunctional processes that are within the system boundary (i.e. “solving multifunctionality by substitution”)

**The following consequences are secondary consequences but should be evaluated for inclusion<sup>121</sup>. Note that they may counteract the primary consequences and partially or completely compensate them, in that case they are rebound effects.**

- Increased general demand for a not required co-function if its market-price is reduced due to its additional availability in secondary consequence of an additional demand for the analysed co-function.
- Incentive-effect on processes to increase their efficiency as secondary consequence of a higher price for its determining co-function(s) in consequence of the increased demand. E.g. increased recycling rates (by more collection, better separation etc.) in consequence of a higher market price for the secondary good, off-setting partially the primary route substitution. Or e.g. increased productivity of biofuel crops (e.g. by putting more fertiliser etc.) in consequence of an increased market price for biofuels, off-setting partially the additional indirect land-use demand that was exemplified above.
- Decreased demand for competing functions (e.g. products) of a not required co-function as secondary consequence of the decreased price of this not required co-function due to increased demand for the analysed co-function and the additional availability of its not required co-function.
- Consumer behaviour changes (e.g. additional car use in cities in secondary consequence of reduced traffic-jams in consequence of better traffic management or attractive public transport).

**Consequences that should only be considered if directly subject of the work and correspondingly named in the goal setting, but not for consequential studies in general. Among others:**

- Increased general consumption by consumers due to the reduced price of a product (as they save the money and can spend it on other products). Note that this secondary consequence is counteracted by the fact that the workers in the supply-chain of the cheaper product receive less overall salary and will hence consume less.

---

<sup>121</sup> Note that for a number of cases the secondary consequences may not be applicable at all or it is very difficult to interpret / transfer them. This is often caused by constraints to the analysed process / system or its co-functions. In some cases, the effect can be that strong, that the consequence is not acting via a homogeneous market, but directly (e.g. district heating with the constraint of very limited mobility of the co-product heat). In such cases, it should be considered to model the specific or generic situation instead of a market consequence.

- Changed consumption patterns as secondary consequence of more time availability to consumers as consequence of a consumer product saving the consumer's time (e.g. dishwashing machine vs. manual dishwashing).
- accelerated product / technology investments in the analysed process/technology or competing products or technologies (e.g. solar electricity or competing energy technologies).

### Terms and concepts: Secondary consequences

Secondary consequences are also known as “rebound effects”, “back-fire effects”, “off-setting effects”, “ripple effects”: When modelling consequences in the market as result of the decision to produce a good, a range of mechanisms exist that counteract and partly or fully may compensate them, hence the term “rebound effect”. However, such secondary consequences may also increase the effect of the identified consequence or lead to fully different consequences than the direct ones modelled considering only the primary consequences, hence here the use of the broader and more encompassing term “secondary consequences”<sup>122</sup>.

It is important to note that these effects are typically far from linear and when certain thresholds are passed a complete shift of parts of the market can be the effect (e.g. when the production cost of wind-power makes it fully competitive in certain market segments). A list of these mechanisms is found above this box.

That list indicates the complexity of identifying and especially quantifying the typically very specific consequences. For some of these there is even a lack of theoretical models to capture the various primary and secondary consequences and their interaction. This is of course no problem that would be inherent to LCA but to all models that aim at forecasting future developments in market and society context.<sup>123</sup>

<sup>122</sup> It is a relevant characteristic that the primary and secondary consequences on the inventory of analysed product system can be both positive and negative, depending on the specific consequence. The question of increasing or declining markets plays furthermore a large role in identifying the superseded marginal process highly uncertain in future scenarios. For the model of the main product system this has the tendency of higher impacts than obtained with attributional modelling in case of rising markets or lower ones for falling markets. In fact does the respectively superseded processes represent (very roughly) the extremes in terms of best and worst environmental performance in the market of that product. This is unless investment limitations may lead to install an older technology nevertheless in a growing market. For solving multifunctionality the possible influence on the results is bigger, as often other kinds of products are superseded. That means that already the uncertainty of knowing whether a specific market of e.g. a material or part is growing or falling is a very substantial factor that can change the outcome of the analysis.

<sup>123</sup> One effect may be illustrated that shows the difficulty to identify the superseded process due to the complexity of interrelating consequences in the market. It also serves to illustrate the greater robustness of using e.g. the market mix in substitution as a simplified requirement: counteracting market price shifts due to additionally available co-products: An extra availability of the co-produced material “X” would in classical consequential modelling supersede/avoid the production of the least cost-competitive material “Y” (or another production route for material “X”: “Xa”). This would be credited by subtracting the inventory of “Y” (or “Xa”). However, the additional availability of “X” results - along the same logic of market consequences - also in a marginal decrease of the market price for “X”. That means that “X” becomes economically more attractive compared to other competing, functionally equivalent materials (e.g. “U” and “Z”) in all types of applications. In marginal consequence, marginally less of “U” and “Z” would be produced, as “X” would be replacing them to some degree. Hence the market mix production of “U” and “Z” can equally be argued to be superseded by the co-produced “X”, and not only “Y” or “Xa” as considering only the primary consequences.

### 7.2.4.3 Constraints and other market imperfections to be considered

Real markets face various constraints and other market imperfections. Real markets are moreover not fully informed, i.e. the operated technologies and products on the market are not only the most cost competitive ones.

Similarly as for the mechanisms and consequences, also constraints can be very diverse. There is no possibility to identify the relevant ones on a general level. They are hence to be identified for the given case.

Notwithstanding this but providing basic guidance on this question, the following recommendations are made:

#### **Constraints that should be considered in consequential modelling are:**

- Existing long-term supply-contracts or co-operations that cannot easily be changed
- Prohibitively high costs that are a barrier to changes, such as limited mobility of the products (e.g. for basic construction materials over longer distances, for heat)
- Existing or expected political measures / legal constraints that stimulate perceived positive developments or counteract perceived negative developments (e.g. take-back fees for packaging materials, land-fill bans and other technology-related constraints, green tax incentives e.g. for solar energy, material bans, etc.)
- Non-scalability of supply of products or natural resources that are required for the modelled system. E.g. hydropower, depending on the country/market (see also chapter 6.8.2), or recycled materials which achieve already a recycling rate close to the feasible maximum. Fully used, dependent co-products of joint production, whose production cannot be scaled up, are of this type of constraint.
- Monopolies, where there is hence no choice of the supplier or technology

#### **Constraints that may additionally be considered in consequential modelling are:**

- Other constraints in place or expected to be in place that increase, decrease or block a primary or secondary consequence

### 7.2.4.4 Identifying the processes of the consequential model

(No corresponding ISO 14044:2006 chapter but relates to aspects of chapters 4.2.3.3.2, 4.2.3.6.2, and 4.3.2.1)

#### **Overview**

The next step is to identify the specific processes that are to be modelled, i.e. the processes that are operated or displaced as effect of the considered consequences and taking into account the relevant constraints.

Apart from using or developing data that sufficiently represents the year for which the scenario is made (e.g. 2020), as a general guidance the following criteria are to be considered for the consequential modelling of the primary consequences "(a)" and "(b)" (see above in chapter 7.2.4.2):

- Size of effect (either "small" or "big"),
- market situation (i.e. either "growing, stable or slightly declining" OR "strongly declining" market), and
- cost-competitiveness of alternative processes (i.e. technologies).

The following text provides more details:

### **The first step: consider the primary consequence and the size of the effect**

The size of the effect of the consequences on other processes in the economy matters in so far, as there are two main cases to be differentiated. In the first step only the primary consequence (a) in the market (see above) is considered; this is the consequence classical consequential modelling has initially only been looking at:

- Is the size of the effect "small"?:
  - The size of the effect is so small that it can be assumed that the analysed decision is NOT able to via market effects directly cause an increase in capacity to meet the additional demand or a reduction of existing capacity in consequence of the additional supply, respectively. This increase or reduction in capacity is understood to be a change in addition to anyway ongoing installation or decommissioning in the market. Note that this applies - as always - not only to production capacity e.g. of materials or energy carriers, but also to the available capacity of services.
  - The effect should generally be considered small in this sense, if the annual amount of additional demand or supply is smaller than the average percentage of annual replacement of capacity (see chapter 5.3.6) of the annual supply of that function or system in the given market; if that average percentage is over 5 %, 5 % should be used instead. This is for orientation only and can be for a given case changed to be smaller or bigger upon the argumentation that the change in demand or supply is directly triggering changes in demand and not only via a marginal accumulative effect in contribution to the general market demand/signal. Given the elasticity of markets, counteracting secondary consequences and constraints, it can be assumed that small changes in demand and supply do not trigger long-term investments in real markets. The signal they send is too small to overcome the threshold that would have to be overcome to structurally change capacity.
- Is the size of the effect "big"?:
  - The size of the effect is big enough that it can be assumed that the analysed decision IS able to via market effects directly cause an increase in capacity to meet the additional demand or a reduction of existing capacity in consequence of the additional supply, respectively.
  - This should be generally assumed, if the annual amount of additional demand or supply is bigger than the average percentage of annual replacement of capacity (see chapter 5.3.6) of the annual supply of that function or system in the given market; if that average percentage is over 5 %, 5 % should be used instead. As above, the percentage is for orientation and can be changed upon analogous argumentation as for the "small " effect above.

If the size of the effect is "small", the affected processes / systems are always the "short-term marginal" processes / systems. If it is "big":

### **The second step: consider secondary consequences and constraints**

Depending on the size of the effect and considering secondary consequences and constraints, the processes mix that best represents the superseded processes is to be narrowed down, as follows:

- If the size of the effect - considering only the primary market consequence - is "small", it should first checked whether secondary consequences and constraints in the market counteract the primary consequence (rebound), so that the net effect is "close to zero" (i.e. different from "small" in the previously described sense), compared to the full effect

after the primary consequence. In that case, the "short-term marginal" is best represented by the "average market consumption mix" of the processes / systems (i.e. the same as the average background data in attributional modelling).

- If the size of the effect - considering only the primary market consequence - is "big", it should next be checked whether secondary consequences and market constraints counteract the effect, so it is not "big" anymore, but "small". In that case the above provisions for "small" effects apply for this process.
- If secondary consequences and market constraints do not counteract the primary consequences effect strong enough to change it be "small" it must still be considered "big". However, the quantitative extent and the affected processes might have been changed by the secondary consequences and constraints. This has to be analysed specifically, as to correctly identify the final consequences.

### **The next steps: market situation and the cost-competitiveness**

The processes / systems that will be affected depend on the specific market situation and the cost-competitiveness of the alternative processes that can provide the required function. Two cases are to be differentiated regarding the market situation:

- a mid-term growing, stable or only slightly declining market, i.e. declining not more than the average displacement rate of capital equipment,
- a mid-term strongly declining market, i.e. declining more than the average displacement rate of capital equipment for the respective equipment.

The above named average displacement rate in % is obtained by dividing 100 years by the average or typical life time of the capital equipment. E.g. a plant for producing a material X might have a life time of 25 years. Accordingly,  $100 \text{ years} / 25 \text{ years} = 4 \%$  are replaced annually.

Regarding the "market" it is to be stressed that here the market of the specific e.g. commodity or product should be used and not their broader functions or product groups but also not the market of the specific brand: the market for a specific commodity (e.g. cadmium) or product (e.g. lead based solder paste) might be declining, while the market of some of the functions of the commodity (e.g. energy-storage in batteries, solar energy capturing in thin film solar panels) or the product group to which the product belongs (e.g. solder paste in general) might be growing, and vice versa. As especially constraints may often act directly or indirectly on specific commodities or products (while seldom on the level of brands), their specific market is of relevance here.

Based on the above definitions and two cases, the next question for the situation of "big" effects is whether the extent of additional demand or supply is changing the direction of the market, i.e. from a "strongly declining" market to a "slightly declining, stable, or growing" market OR vice versa. If this is NOT the case, the affected processes / systems are always the "long-term marginal" processes / systems.

The next question - for both "small" and "big" effects (while not changing the market direction) is the question of the current market direction and how it modifies which processes are affected by additional demand or supply: In a growing (or at least not strongly declining) market, an additional demand for more capacity for a function can be reasonably assumed to be met by installing the most cost-competitive e.g. technology, using the most cost-competitive raw material route, operating the most cost-competitive waste treatment service, etc. Similarly, for additional short-term demand, the most cost-competitive processes will be used. If a market is however strongly declining, additional demand for more capacity will not be met by installing new capacity, but by NOT decommissioning existing capacity (that

otherwise would have been decommissioned, i.e. keeping the least cost-competitive ones in operation). Again, in analogy, also for additional short-term demand, the least cost-competitive supplies will be used. Accordingly, if the market is "growing, stable, or slightly declining", the "short-term marginal" (for "small" effects) and the "long-term marginal" (for "big" effects) are the most cost competitive processes / systems. If the market is "strongly declining" these are the "least cost-competitive" processes / systems, for both "small" and "big" effects.

If however the extent of additional demand or supply is "big" and IS also changing the direction of the market, a part of the affected processes / systems are those that are affected in strongly falling markets and another part those of growing, stable or slightly declining markets, i.e. a specific combination of two different sets of "long-term" marginals, depending on the share of capacity affected.

### **The final step: identifying the mix of "short-term" or "long-term" marginal processes / systems**

There is the general lack of full information in the market and a high uncertainty in determining future cost competitiveness of processes and systems. This has the effect - as reality shows - that in most markets several alternative, similarly cost-efficient alternatives compete and are installed at the same time; there is no strict "the one, most cost-efficient technology only" logic in the real world<sup>124</sup>.

An example may be the production of steel in China in 2015, where the (one or several) marginal processes are those steel plants and ore/scrap routes that are forecasted to be most cost-effective among the potentially newly installed ones in the reference year of the study.

Also in the consequential model therefore not a single, short-term or long-term marginal process should be modelled but a mix of the most likely marginal processes, resulting in much more robust models. This is especially important if the various most likely marginal processes have a similar, not significantly different cost competitiveness and at the same time their environmental profile is significantly different. To restrict the model to a single marginal process or system is only justifiable if there are no other, similarly cost-competitive processes or systems and hence the use of a single one is more appropriate.

## **7.2.4.5 Further aspects, recommendations, and observations**

### **Various items**

If the market is close to or at the border between slightly and strongly declining, it is recommended using the average market consumption mix. Note that these cases are identical to attributional modelling of the main system.

Note that all the above also applies when the extra supply is partly or fully unused (e.g. deposited) or undergoing low-value uses (e.g. waste incineration with energy-recovery). These processes contribute to the marginal mix. Analogously, if the analysed extra demand uses otherwise partly or fully unused functions (e.g. originally deposited or incinerated waste), the "avoided waste treatment", if any, is credited to the using system. All interim steps

---

<sup>124</sup> Reasons are among others that different actors seem to identify different technologies as the most cost-competitive ones and hence implement not all the same. And then there are issues of patents and available knowledge/experience on technologies or raw material routes etc. by the different actors, as well as political or society constraints and strategies (e.g. "coal power, CHP natural gas, or nuclear power for electricity base-load?").



from the generation of the end-of-life product or waste to the secondary good(s) (e.g. sorting, purification, transport, etc.) are to be modelled inside the system boundaries until the quality of the to-be-substituted co-function is actually replacing the superseded processes. In the case of "closed loop" and "open loop - same primary route" recycling, and if the substitution is not equal 1:1 (e.g. due to down-cycling), the actually substituted amount should be credited. If the specific substituted processes are not known or the amount cannot be quantified, market value correction should be applied to the superseded processes' inventories. The correction factor is hence the ratio of the market prices for the secondary good versus that of the same amount of the primary good.

### **Indirect land use changes - overview**

Indirect land use changes (ILUC) are an aspect under consequential modelling. This issue refers to the situation that an additional demand for land, e.g. to produce a crop-based biofuel, means that the crop that would be produced otherwise on this land has to be produced elsewhere, it is "displaced". The assumption behind this is that additional production of e.g. the biofuel does not change the total amount of other crops produced globally or in that region, i.e. is in addition on a net basis. As the land where that other crop now needs to be produced is also producing something else, ultimately former un-used land (i.e. nature, fallow) needs to be transformed to produce that "displaced" crop. I.e. the additional demand for biofuel is assumed to result in indirect land use changes elsewhere (see also the related example in footnote 20). This is a primary consequence of the type (a) listed in chapter 7.2.4.2.

One example for secondary consequences is that the marginally increased price of the displaced crop (and potentially to some degree even of land intensive goods in general) might be an incentive for achieving higher yields by use of more fertilisers and better management. This might partly off-set/reduce the need for an indirect land use change and less land needs to be changed elsewhere than the amount now used for the biofuel.

At the same time it is necessary to consider the different productivity of the used and the indirectly changed land e.g. may the "displaced" crop have had a harvest of 5 t per ha on the land now used for biofuel, while the indirectly changed land of e.g. rainforest may yield only 3 t per ha, i.e. more than one ha is necessary for each ha from which the former crop is displaced.

Note that in the logic of consequential modelling this applies to all land uses, including food production, industrial plants, private homes etc., whenever a decision support is intended with the study.

### **Indirect land use changes in consequential modelling**

As no widely accepted provisions exist for indirect land use, but such are still under development by several organisations, no specific provisions are made at this point. The appropriate way how to integrate indirect land use changes is hence to be developed for the specific case, in line with the general provisions of consequential modelling. This is unless specific provisions would be published under the ILCD. Such provisions might be part of a future supplement.

## 7.2.4.6 Solving multifunctionality of processes in consequential modelling

(Refers to aspects of ISO 14044:2006 chapter 4.3.4.2)

### Introduction

Multifunctionality in consequential modelling is solved - somewhat similarly as in attributional modelling - in a two-step procedure next to subdivision / virtual subdivision.

The preceding step (subdivision and virtual subdivision) is identical, with one exception: partial subdivision that cuts through a multifunctional process should be avoided as it renders the substitution (see below) distorted.

The first step, if subdivision and virtual subdivision are not possible or feasible, depends on the question whether the amount of the co-functions can be entirely independently varied. Details see below.

### Subdivision and virtual subdivision

For subdivision and virtual subdivision of black box unit processes the related provisions of chapter 7.4.2.2 apply analogously for consequential modelling.

The logic is that the additional amount of the not required co-function can be assumed to be counteracted by changing the production scheme of the other plants that produce the same co-functions so that the total amount of all of them is unchanged. Note that under consequential modelling, virtual subdivision shall not be done if it "cuts" through a physically not subdividable multifunctional joint process. This would distort the substitution.

### Physical causality in case of true combined production, substitution for joint production

In the case subdivision and virtual subdivision are not possible or feasible, the next step depends on the question whether the multifunctional process is a case of combined production or of joint production: if the amount of the co-functions can be entirely independently varied without changing the production facilities, this is called combined production. Examples are most cases of multi-waste incineration, combined transport of different goods. If this is not the case, this is called joint production. Examples are NaOH and Cl<sub>2</sub> production by electrolysis of NaCl, production of wheat grains and wheat straw.

Note that many processes that appear to be combined processes are in fact not fully variable without changing the installed capacity or the nature of the processes, often at high costs (e.g. refinery with its many products that can be varied only to a certain extent without resulting in the need to install additional production plants, purchase external hydrogen, etc.).

For true combined production, the determining physical causality (i.e. the first of the two steps of allocation under attributional modelling) equally applies.

For joint production, substitution as a special case of system expansion is the solution to multifunctionality. This is drawing closely on the provision for general consequential modelling. This is detailed in the further parts of this chapter.

### Joint production - substitution in general cases of multifunctionality

For the primary consequences of solving multifunctionality via substitution (primary consequence "(b)" of above chapter 7.2.4.2), the same provisions apply as detailed in the preceding chapter on the primary consequences "(a)".

Methodologically these cases are equivalent to general consequential modelling, as also acknowledged in ISO 14044:2006. There are however a few, practical differences of relevance to consider, that can in principle also occur in general consequential modelling, but

are much more frequent in cases of solving multifunctionality. These are namely the need for interim treatment steps, especially for cases of waste treatment where the valuable co-product is only generated after several steps and the change in inherent properties of e.g. secondary goods; there is not always an (alternative) production route for exactly that secondary good. For these reasons specific approaches have often been developed and additional ones for modelling substitution in end-of-life product and waste treatment.

A special case of multifunctionality is the system-system relationship (concept see box in chapter 7.2.2), that under consequential modelling effectively requires the substitution of the short-term marginal.

### Joint production - substitution/credits in end-of-life and waste treatment models

A special case is the waste and end-of-life product recycling that typically requires additional steps:

- The modelling of the process steps that condition, modify, transport, etc. the end-of-life products or waste until the valuable function (e.g. a recycled metal bar) is available in a quality and at a place where it is superseding an alternative production (e.g. primary production of this metal bar). These steps are part of the system boundary of the analysed system. In other words: the related inventories are assigned to the analysed system.
- The identification and quantification of differences between the function resulting from the end-of-life product or waste treatment, e.g. due to downcycling (e.g. shortened fibres, reduced mechanical performance of polymers, tramp elements in metals, etc.). This can be done in two ways: either by substituting the reduced amount of function that the to-be-substituted co-function replaces (e.g. may 1 kg recycled polymer replace 0.8 kg primary polymer in the analysed application). Or and especially if the specific uses are unknown, the market-price ratio secondary/primary is used to scale down the inventory of the substituting process or system (e.g. if the secondary, recycled polymer has a market value of 0.7 \$ per kg and the same, primary produced polymer of higher quality costs 0.9 \$/kg, the substituted inventory is reduced by 0.7/0.9, i.e. a factor of 0.778); this is also called "value correction".

In this context, also the true joint co-producing processes are to be identified.

The detailed provisions are given in a separate chapter in annex 14.5.

## 7.2.4.7 Initial description of identified processes

(Refers to aspects of ISO 14044:2006 chapters 4.2.3.3.2)

Especially for the processes of the foreground system, an initial description is required. This will be revised when collecting and documenting the unit process data. Details on documentation are given in chapter 10.

Unless the deliverable of the LCA is a unit process data set: For those product flows that connect the foreground system with the background system, a detailed specification including of their function and functional unit is required.

### Provisions: 7.2.4 Identifying processes in consequential modelling

Applicable for those processes in Situation B that have large-scale consequences, and for use in assumption scenarios in Situation B (if consequential elements are included in those).

Fully applicable to all types of deliverables, except for unit processes.

## Provisions: 7.2.4 Identifying processes in consequential modelling

### Expertise (7.2.4.1) [ISO+]

- I) **SHOULD - Required expertise:** Experts in the following domains should be involved in the study, especially for identifying and modelling large-scale consequences:
  - I.a) technology development forecasting (e.g. learning curves, experience curves),
  - I.b) scenario development,
  - I.c) market cost and market forecasting,
  - I.d) technology cost modelling, and
  - I.e) general-equilibrium and partial-equilibrium modelling.
- II) **SHOULD - Policy scenario experts required?:** The involvement of domain experts for policy scenarios is recommended regarding their function as setting constraints. In the case policy scenarios are explicitly analysed in the study, such experts should be involved.

### Identifying consequences and constraints to be considered [ISO+]

- III) **SHALL - Modelled consequences:** Identify among the following ones those consequences that will be modelled; this step may be taken separately case for each process. Their potential exclusion shall be justified by demonstrating at least argumentative / semi-quantitative that they are not relevant for the results; otherwise the exclusion shall be considered when reporting achieved accuracy (in case of data sets) and when interpreting the results (in case of LCA studies): (7.2.4.2)

#### III.a) Primary market consequences:

- III.a.i) **SHALL - (a)** Processes that are operated as direct market consequence of the decision to meet the additional demand of a product (i.e. “consequential modelling of direct consequences; applied for the full system”). This includes among many others also indirect land use effects.
- III.a.ii) **SHALL - (b)** Processes that supersede / complement not required co-functions of multifunctional processes that are within the system boundary (i.e. “solving multifunctionality by substitution”, reducing the system boundary to exclude the not required function(s)).

#### III.b) Secondary market consequences:

- III.b.i) **SHOULD -** Increased demand for a co-product if its market-price is reduced.
- III.b.ii) **SHOULD -** Incentive-effects on a process to increase its efficiency due to a higher price for its product(s).
- III.b.iii) **SHOULD -** Decreased demand for competing products of a co-product due to the decreased price of the co-product.
- III.b.iv) **SHOULD -** Consumer behaviour changes
- III.b.v) **SHOULD -** Further consequences should only be included if explicitly addressed in the goal of the study.

### Provisions: 7.2.4 Identifying processes in consequential modelling

- IV) **SHALL - Constraints:** Identify the constraints that will be included in the model and that may partly or fully prevent that the marginal process mix as identified along the primary and secondary consequences can directly be used in the system model. The likely specific effect of any included constraint shall be considered when identifying the effective marginal process(es). Their potential exclusion shall to be justified by demonstrating at least argumentative / semi-quantitative that they are not relevant for the results; otherwise the exclusion shall be considered when reporting achieved accuracy (in case of data sets) and when interpreting the results (in case of LCA studies). The following constraints should be considered (7.2.4.3):
- IV.a) Existing long-term supply-contracts or co-operations that cannot easily be changed.
  - IV.b) High costs that act as a barrier (e.g. limited mobility of some products due to high transport costs).
  - IV.c) Existing or expected political measures / legal constraints that stimulate perceived positive developments or counteract perceived negative developments. (E.g. a political binding target of X % of energy carrier Y in the fuel mix means that energy carrier X is already pre-set and cannot be assumed to be a long-term marginal product in consequence of the analysed decision.)
  - IV.d) Non-scalability of supply of products or natural resources; including of fully used, dependent co-products of joint production.
  - IV.e) Monopolies, i.e. lack of choice of the supplier or technology.
  - IV.f) It is recommended to also consider other constraints in place or expected to be in place that increase, decrease or block a primary or secondary consequence.

### Identifying the mix of superseded processes /systems [ISO+]

- V) **SHOULD - Stepwise identification of the mix of superseded processes / systems:** Identify the processes / systems within the system boundary that are superseded as consequence of the analysed decision on the investigated system(s)<sup>125</sup>. For each process the following steps should be applied, starting from the system's functional unit or reference flow to the entire foreground system and following the identified consequences and constraints of a theoretical "supply-chain - use - end-of-life" logic to include identifying as minimum all product and waste flows (or their functional units) that cross the border to the background system<sup>126</sup>: (7.2.4.4)
- V.a) **Primary market consequence and the size of the effect:** First step - consider the primary market consequence and the size of the effect:
    - V.a.i) Identify the processes that are assumed to be additionally operated or taken out of operation as primary market consequence of the analysed decision and the directly related additional or reduced demand for a

<sup>125</sup> See also the related decision tree diagram in Figure 21.

<sup>126</sup> It depends on the chosen background system model solution whether the processes of the background system also need to be individually identified or whether - if embedding the foreground system into an existing background system - this work has been already done.

### Provisions: 7.2.4 Identifying processes in consequential modelling

function/product, considering the following:

V.a.ii) Size of effect:, EITHER

V.a.ii.1) "small" - affecting only the extent of operation of one or more existing processes --> the short-term marginal process(es) are the ones that should be assumed to be superseded, OR

V.a.ii.2) "big" - resulting in additionally installed or de-installed capacity - -> the long-term marginal processes are the ones that should be assumed to be superseded.

V.a.ii.3) The effect should generally be considered "small", if the annual amount of additional demand or supply is smaller than the average percentage of annual replacement of capacity (see chapter 5.3.6) of the annual supply of that function or system in the given market; if that average percentage is over 5 %, 5 % should be used instead. Otherwise it is "big". The percentage is for orientation only and can be for a given case changed to be smaller or bigger upon the argumentation that the change in demand or supply is directly triggering changes in demand and not only via a marginal accumulative effect in contribution to the general market demand/signal.

V.b) **Secondary consequences and constraints:** Second step - consider secondary consequences and constraints:

V.b.i) If the size of the effect of the primary market consequence is "small", check whether the secondary consequences and constraints in the market counteract the primary consequence (rebound), so that the net effect of the consequences is so small that it is not significantly different from being zero. In that case, the "short-term marginal" is best represented by the "average market consumption mix" of the processes / systems (but see next sub-provision).

V.b.ii) For the specific case of multifunctionality, a key constraint occurs if the required co-function is an already fully used, dependent co-function of a joint production process (e.g. copper ore mining with silver as dependent but fully used co-product, egg-laying chicken with the dependent co-"product" chicken being fully used for human food or animal fodder), as additional demand cannot be met by additional supply on a net basis. In that case, the required function/product will have to be produced in another way (e.g. for the above examples: silver from silver mine, or meat-chicken directly raised for food or fodder).

V.b.iii) If the size of the effect of the primary market consequence is "big", check next whether secondary consequences and market constraints counteract the primary consequence, so that the net overall effect is not "big" but "small".

V.b.iv) For those processes that are still facing "big" effects, explicitly consider that the affected processes might have been changed by the secondary consequences and constraints. This has to be analysed specifically to

### Provisions: 7.2.4 Identifying processes in consequential modelling

correctly identify the final effect / superseded processes.

V.c) **Market situation and the cost-competitiveness:** Third step - market situation and the cost-competitiveness of alternatives:

V.c.i) Market direction, EITHER

V.c.i.1) a "growing, stable, slightly declining market" (i.e. declining less than the average equipment replacement rate, OR

V.c.i.2) a "strongly declining market" (i.e. declining faster than the average equipment replacement rate).

The above named average displacement rate in % is obtained by dividing 100 years by the average or typical life time of the capital equipment, expressed in years.

V.c.ii) Based on this: analyse whether the extent of additional demand or supply for the effect "big" is changing the direction of the market, i.e. from a "strongly declining" market to a "slightly declining, stable, or growing" market OR vice versa.

V.c.iii) If this is NOT the case, the affected processes / systems are always the "long-term marginal" processes / systems.

V.c.iv) For all "small" and "big" cases in addition the cost-competitiveness of alternative processes / systems is relevant:

V.c.iv.1) If the market is "growing, stable, or slightly declining", the "short-term marginal" (for "small" effects) and the "long-term marginal" (for "big" effects) are the most cost competitive processes / systems.

V.c.iv.2) If the market is "strongly declining" the "short-term marginal" (for "small" effects) and the "long-term marginal" (for "big" effects) are the "least cost-competitive" processes / systems.

V.c.v) If in contrast the market direction IS changing, both the least and the most cost-competitive processes / systems are superseded and their specific type and share needs to be identified individually, drawing on the other provisions of this chapter.

V.d) **Identifying the mix of processes /systems:** Final step - identifying the mix of "short-term" or "long-term" marginal processes / systems:

V.d.i) In the consequential model, not only one single, short-term or long-term marginal process should be modelled but a mix of the most likely marginal processes, given the high uncertainty of market price forecasts and the often large differences of the environmental profiles among alternative marginal processes. To restrict the model to a single marginal process or system is only justifiable if there are no other, similarly cost-competitive processes or systems and hence the use of a single one is more appropriate.

V.d.ii) The final amount of function (process or system) that is superseded shall be approximated considering the combined effect of primary and secondary consequences and constraints.

## Provisions: 7.2.4 Identifying processes in consequential modelling

Note that in case the market direction has changed as consequence of the analysed decision, the superseded processes are a specific combination of the least cost-competitive ones and partly the most cost-competitive ones.

### Further provisions, comments, and recommendation on documentation (7.2.4.5) [ISO+]

VI) SHALL - Observe that:

VI.a) **Part-system and system-system relationships:** These need special attention (e.g. for energy related products) and correct inventorying. Note that these cases are modelled identically in attributional modelling.

VI.b) **Individual processes within the background system:** These may need to be identified as well when identifying significant issues (see chapter 9.2) or if required to meet the specific goal of the study.

VI.c) **Meet representativeness requirements:** The requirements regarding technological, geographical and time-related representativeness shall be met.

VII) SHOULD - **Indirect land use changes:** The appropriate way how to consider indirect land use changes should be developed. If done this shall applying the general provisions on consequential modelling as applicable. This is unless specific provisions would be published under the ILCD. Such provisions might be part of a future supplement.

VIII) MAY - **Schematic consequential model diagram:** It is recommended using the system boundary scheme for overview. Schematic decision-consequence and flow diagrams of the most relevant consequences and marginal processes of the system(s) may be used to document the main identified consequences and constraints and the resulting resource bases, technologies, affected markets, etc. This can serve as basis for a data collection planning and later documentation.

Note again, that any exclusion of individual processes or activity types shall be justified using the cut-off criteria (see chapter 6.6.3). In principle all processes are to be inventoried that are operated in consequence of the analysed decision. This includes in principle - depending on the system boundary - activities such as e.g. mining, processing, manufacturing, use, repair and maintenance, transport, waste treatment and other purchased services such as e.g. cleaning and legal services, marketing, production and decommissioning of capital goods, operation of premises such as retail, storage, administration offices, staff commuting and business travel, etc.

IX) MAY - **Initial processes' description:** It is recommended to also provide an initial description of the identified unit processes of the foreground system and the detailed functional units of those product and waste flows that link it to the background system. This should complement the documentation of the consequences and constraints and be completed with details during the iterations of the LCI work. (7.2.4.7)

### Solving multifunctionality of processes and systems (7.2.4.6) [ISO!]

X) SHALL - **Subdivision and virtual subdivision:** Subdivision and virtual subdivision shall be applied in preference to substitution. Provisions see chapter 7.4.2.2<sup>127</sup>.

<sup>127</sup> Observe that virtual subdivision shall not be done if it "cuts" through physically not separable joint processes, as this would distort the substitution.



### Provisions: 7.2.4 Identifying processes in consequential modelling

- XI) **SHALL - Combined production:** For cases of truly combined production, the determining physical causality (i.e. the first of the two steps of allocation under attributional modelling) equally applies analogously; see chapter 7.9.3.2.
- XII) **SHALL - Joint production:** For joint production, substitution as a special case of system expansion is the preferred solution to multifunctionality. This shall be done as follows:
- XII.a) The same provisions shall apply as for general consequential modelling of the system.
- XII.b) Note the specific constraint for already fully used, dependent co-products of joint production: since their production cannot be increased with that same multifunctional process/technology, their additional provision cannot be modelled. Instead, alternative routes need to be modelled for their supply. This means that the determining co-product shall not be substituted.
- XII.c) If for the not required co-function functionally equivalent alternative processes / systems are operated / provided in a commercially relevant<sup>58</sup> extent, the not required co-function shall be substituted with the mix of the superseded marginal processes (excluding the substituted process-route, if quantitatively relevant). Differences in functionality between superseding and superseded function shall be considered by correction of the actually superseded amount of the superseded process(es) or by market price correction of the superseded process(es)' inventory (if the superseded amount is not known in sufficient detail).
- XII.d) If such alternative processes / systems do not exist<sup>128</sup> or are not operated in a commercially relevant extent, the provided function in a wider sense should be used for substitution<sup>129</sup>.

Note that the substituted processes or products may also have secondary functions. This can theoretically lead to the problem of an eternally self-referring and/or very extensive, multiply extended system. As the amount of these secondary functions and their relevance within the overalls system goes down with each process step, this problem can be avoided / reduced by applying the cut-off rules.

### Substitution for multifunctional processes and systems in reuse / recycling / recovery (7.2.4.6) [ISO!]

- XIII) **SHALL - Recycling, recovery, reuse, further use:** Substitution shall be applied for cases of recycling, recovery, reuse, further use: (7.2.4.6, and for all details see annex 14.5)
- XIII.a) **Applying general rules to these cases:** Substitution of products recycled or recovered from end-of-life product and waste treatment follows the same rules as

<sup>128</sup> E.g. for wheat grain production, many refinery products, etc.

<sup>129</sup> E.g. as for NaOH apart from NaCl electrolysis, or if for a mobile phone the individual function SMS would not be available as commercially relevant, separate consumer product. NaOH provides the general function of neutralising agent and hence other, technically equivalent and competing neutralising agents, KOH, Ca(OH)<sub>2</sub>, Na<sub>2</sub>CO<sub>3</sub>, etc. can be assumed to be superseded. For the case of wheat grain and straw production: instead of straw other dry biomass (e.g. Miscanthus grass, wood for heating, etc.) provides equivalent functions and can be assumed to be superseded.

### Provisions: 7.2.4 Identifying processes in consequential modelling

for the general cases of multifunctionality. They shall be applied for all cases of waste and end-of-life treatment (i.e. "closed loop" and of "open loop - same primary route" and "open loop - different primary route"). Subdivision and virtual subdivision shall be applied in preference to substitution. Provisions see 7.4.2.2.

XIII.b) **Specific aspects and steps (true joint process, interim processes to secondary good, recyclability, ...):** Specific for reuse/recycling/recovery is that interim treatment steps occur more regularly and that often no truly equivalent alternative process / system exist<sup>130</sup>. In this context, also the true joint process of the secondary good is to be identified. Finally, the steps of reuse/recycling/recovery need to be modelled explicitly until the secondary good is obtained that is actually superseding an alternative process / system. The actual mix of superseded processes shall be identified for the given case and along the following steps:

XIII.b.i) The true joint process of the secondary good is that process step in the product's life cycle that provides the good with the closest technical similarity to the secondary good; the thereby identified primary good shall not have a lower market value than the secondary good<sup>131</sup>.

XIII.b.ii) The recyclability substitution approach shall be used for substitution. That implies that all interim waste management, treatment, transport etc. steps are to be modelled and assigned to the analysed system including the step that is producing the valuable co-function (e.g. secondary metal bar).

XIII.b.iii) The amount/degree of recyclability shall refer to the actually achieved recyclability, i.e. accounting for all kinds of losses, e.g. loss due to incomplete collection, sorting, recovery, during recycling processing, rejection etc. In short, the recyclability is the %<sup>132</sup> of the amount of end-of-life product or waste that is found in the secondary good(s). For practical reasons and for long-living products this should per convention be the currently achieved recyclability for this product (or for new / projected products the achieved recyclability of comparable products in the same market). This can be another reference if the goal of the study explicitly relates to recyclability scenarios.

<sup>130</sup> This is as secondary goods often have distinctly different properties from primary produced goods (e.g. recycled aged plastics vs. primary plastics), what makes a clear assignment to the equivalent or most similar process / system more difficult.

<sup>131</sup> This serves to avoid a potentially misleading upscaling of the superseded function's inventory in case of applying market value correction when correcting for the functional differences.

<sup>132</sup> Note that this % needs to relate to the appropriate property and unit of the secondary good, e.g. Mass in kg for recycled materials, Lower calorific value in MJ for recovered energy, Pieces in number for reused parts, etc.

### Provisions: 7.2.4 Identifying processes in consequential modelling

- XIII.b.iv) The superseded process(es) / system(s) shall be identified applying the general consequential modelling guidance as detailed in the above provisions<sup>133</sup>.
- XIII.b.v) Also here not one marginal process should be used but the average inventories of several of the potential marginal processes.
- XIII.b.vi) For application-unspecific secondary goods, any reduced technical properties of the secondary good should be corrected in the accredited inventory by using the market price ratio (value correction) of the secondary good to the primary produced replaced function.
- XIII.b.vii) For application-specific uses of the secondary goods, sufficient functional equivalence with the superseded good shall be ensured and the credited inventory be reduced to the amount that is effectively superseded. In the case this cannot be determined, the market price ratio (value correction) shall be applied as in the application-unspecific case.
- XIII.b.viii) Especially for the case of "open loop - different primary route" in addition it is to be checked whether commercially relevant alternative processes are operated. Otherwise, the provisions for the general case of solving multifunctionality under consequential modelling shall be applied.
- XIII.b.ix) The other guidance aspects of this chapter on identifying the superseded processes (e.g. constraints, secondary consequences, etc.) apply analogously.

Note that for scenario formation in comparisons, the various primary and secondary consequences and constraints should be varied jointly when defining "reasonably best case" and "reasonably worst case" scenarios.

## 7.3 Planning data collection

(No corresponding chapter in ISO 14044:2006; addressed in many chapters across the standard)

### 7.3.1 Overview

Based on the scope settings and the initially identified principle data and information needs (see chapter 6.9.2) and the initially identified processes within the system boundaries

<sup>133</sup> That means that the earlier named constraint for already fully used, dependent co-products of joint production also applies here: since the production of e.g. a recycled metal as dependent co-product cannot be increased with that same multifunctional process/technology (i.e. by producing more e.g. metal goods, what is of course not happening), its additional provision via primary production cannot be assumed. Instead, alternative routes need to be modelled for the supply of the recycled metal. As stated for the general case, the determining co-product shall not be substituted. The following example explains what that means and why for "closed loop" and "open loop - same primary route" cases nevertheless the primary production is to be substituted: Example: the determining co-product of primary and secondary metal is the primary metal. The secondary metal, after recycling, is the dependent co-product. If this one is fully used in the same or other products and from the perspective of the metal product made of primary metal, recyclability substitution is applied, substituting the secondary good by primary metal. From the perspective of the user of the secondary good "recycled metal", the metal primary production shall not be substituted, but alternative ways of supplying the recycled metal shall be modelled. This alternative way is however - what makes this case apparently specific - the primary production of that metal as this is the only way to increase the availability of the required metal on a net basis. Hence in both cases, primary production is to be substituted, but for different reasons.

(see chapter 7.2), their actual collection and acquisition is to be planned. As for most steps in LCA work, also the data collection planning is iterative.

Before the actual planning of data and information collection can be done it is recommended to get clarity on some fundamentally different options and considerations:

- Foreground system - specific, average, or generic data?
- Background data for attributional and consequential modelling
- Need for multi-annual average data or generic data
- Primary and secondary data sources
- Focus efforts

## 7.3.2 Foreground system data - specific, average, or generic

(Refers to aspects of ISO 14044:2006 chapters 4.2.3.3.2 and 4.3.2.1)

### Avoiding black-box unit processes

When aiming at collecting data for the identified processes within the system boundaries, aim should be to collect data for the actually required processes and not for agglomerates of these with other processes that are not required. This is important for accuracy of the data, for review reasons, as well as for avoiding multifunctionality problems that are otherwise unavoidable.

This can be done by either collecting data exclusively for the required processes or, at least in some cases, by virtual subdivision of collected data, singling out the relevant inventory for the required function. Chapter 7.4.2.2 provides the details.

### Aiming at specific data for the identified processes within the system boundaries

Ideally, the final model of the life cycle of a any system would be represented by producer or operator specific data, i.e. modelling the exact life cycle depicting - as far as required for the study - the supply-chain, use, end-of-life (for attributional modelling) or theoretical consequential supply-chain, use, end-of-life (for consequential modelling).

In practice, and as a general rule, for foreground processes specific inventory data should be used. This data is typically compiled as primary data from the product/technology developer<sup>134</sup>, goods producer, or service operator and should include specific secondary data from the tier-one suppliers (incl. waste service suppliers).

As initial steps during data collection, generic or average secondary background data may be used to identify the need for more representative or specific data. This fully applies to attributional modelling and to a lesser extent to consequential modelling. For processes that are not expected to be key processes of the system, estimations (e.g. based on modelling from process knowledge) may equally provide a first idea of the process data.

### Generic or average data for the foreground system in attributional modelling

Generic or average data may be more appropriate for processes of the foreground system in case the quality of available specific data is considerably lower and the generic or average data sufficiently represents the process. It is important to note that there is no free choice between producer-specific and average or generic data, but the equivalence / representativeness determines this decision.

---

<sup>134</sup> E.g. data on the use stage of consumer products. Other, independent sources may complement this.

For attributional modelling, generic or average background data sets can also be used for foreground processes of little quantitative contribution to the overall environmental impact. They also can be used – as parameterised processes or partly terminated systems – for modelling foreground processes that operate standard machines (e.g. trucks for goods transport, injection moulding machines etc.) where only the specific operating conditions need to be adjusted.

### **Generic or average data for the foreground system in consequential modelling**

For consequential modelling generic or average background data sets may equally help in the foreground system, in case available specific data lacks quality or to fill smaller data gaps. The use of generic parameterised unit process data sets is equally useful as in attributional modelling, if suitable for the specific process / system.

## **7.3.3 Background data for attributional and consequential models**

(No corresponding ISO 14044:2006 chapter but relates to aspects of chapters 4.2.3.3.2, 4.2.3.6.2, and 4.3.2.1)

### **Types of background data**

As detailed in the related box and figure of chapter 6.6.1, the term background system relates to its concept from a data collection perspective<sup>135</sup>.

The types of required background data differ between attributional and consequential modelling.

For attributional modelling this type is the market consumption mix of processes / systems.

For consequential modelling these are:

- mix of "short-term marginal" processes / systems,
- mix of "long-term marginal" processes / systems, and

All these mixes relate to a specific or generic process, good or service (or a wider group of these) in a given market and a given time.

The marginal mixes would either be the most cost-competitive processes or systems (in case of "growing, stable or slightly declining" markets, i.e. declining not more than the average displacement rate of capital equipment) or the least competitive ones (in case of strongly declining" markets; dito). This is unless secondary consequences and constraints change this or even counteract and fully compensate the primary consequences so that the average consumption mix better represents the superseded processes / systems than the marginal mix (respectively in that case both would be identical).

Note that for substitution under Situation A and B, somewhat simplified provisions are made (see chapters 6.5.4.2 and 6.5.4.3).

---

<sup>135</sup> Often also foreground processes are affected by an analysed decision. E.g. may a new production technology result in a strongly reduced process steam demand, what poses the question how the current on-site steam producers are affected as consequence. In such cases however one would rather model a scenario of the likely technology to be installed (or decide whether the steam producer would continue to operate at lower load factor) instead of applying a formal and theoretical consequential identification of the processes. This situation is identical to other micro-effect consequences that can be assumed to rather not change the installed processes.

### **Unit process, parameterised unit process or LCI results data sets for background use**

Background data sets can be of different types: LCI results or unit processes (plus variants of these). Both have their clear advantages and disadvantages. It depends primarily on the availability and quality of the specifically required data, but also on the available expertise in modelling and other aspects, which approach is more suitable. If modelled consistently, combinations are equally possible.

For both unit process and LCI results a good documentation and a qualified and independent external review or panel review are recommended or may be required, depending on the intended application.

When working with unit processes and wherever possible, “Single operation unit processes” should be preferred for data collection over “Black box unit processes” (see Figure 7). This avoids potential problems of multifunctionality and substantially improves verification/review of the data.

For some processes fixed LCI results or unit process inventories may be inadequate. This is if the inventory strongly depends on the specific operating conditions or specific e.g. inputs used. In those cases parameterised unit process data sets or partly terminated system data sets may be required or at least be more efficient and flexible. Examples are e.g. transport processes, flow injection and similar flexible processing machines, waste management processes, etc.

### **Specific, average, or generic data?**

Under attributional modelling and for the situation where no specific supplier is used, as well as for data sets further in the background, country/market technology average or generic background LCI sets are more appropriate, but still the data should represent the level of technology (i.e. real market average or – for scenarios - worst case and best case available), to appropriately represent the products in question.

Under consequential modelling, average data is not well suitable in theory, unless there is a high uncertainty on which are the superseded processes, what often is the case.

## **7.3.4 Need for multi-annual average data or generic data**

Using data that is averaged over several years may also be necessary in cases where a single year is not representative for the general, “current” situation. This applies in cases where data varies considerably among years. This could for example be the case for agricultural products, where e.g. yield, the resulting nitrogen surplus and related emissions, pesticide amounts applied, etc. can differ considerably among years due to different meteorological conditions, disease incidents, and the like. Also the load of industrial plants and e.g. import-mixes of raw materials can vary considerably among years. This especially applies to data that represents a specific producer as the data can be expected to vary stronger than the data of the market mix.

Similar as average data also generic data can in such cases often better represent the process or system than specific data.

Such situations can be identified along historical data from different years of the analysed or similar process that differ significantly. It may also be that only for the intended year of modelling specific incidents have occurred that quantitatively have affected the process’ output or other relevant inventory items in a unique and hence not generally representative way.

This case is also one example where average or generic data may have higher overall quality than specific data.

## 7.3.5 Primary and secondary data sources

### LCI data

Based on the specific data needed and the quality requirements, and with the above considerations, the sources for the data and information are to be identified. Consistency and quality as well as quality assurance of data (i.e. review) are important requirements that support valid studies. As already addressed in chapters 6.9.3 and 6.9.4, a wide range of potential LCI data sources exist:

- Primary data sources are the producers of goods and operators of processes and services, as well as their associations.
- Secondary data sources which either give access to primary data (possibly after re-modelling / changing the data) and to generic data are e.g. national databases, consultants, and research groups.

The ILCD Data Network helps in identifying suitable secondary sources.

It is recommended to well consider the specific data sources, as changing data sources during the process of modelling is likely to not only delaying the work, but also likely to result in considerable additional costs.

### Other data: recycling rates, statistical data, etc.

Similarly as for the LCI data, also for other data the choice of the sources is an important step that should be taken systematically. See also chapter 6.9.4.

## 7.3.6 Focus on most relevant data and information

It is recommended to balance the effort of data collection by the relevance of the respective data and information. To be efficient and to effectively using the available resources of time and money to provide the best attainable quality, LCA work needs to be focussed, avoiding to get lost in the huge amount of theoretically contributing processes, flows and aspects. Building on existing experience that sufficiently reflects the analysed process or system and that is of high quality is an essential guide. Product Category Rules (PCR) and product-group specific guidance documents can represent this experience.

### Frequent errors: Wrong focus of data collection

It can often be found in LCA practice that the focus of data collection is not properly guided by relevance of that data for the final results: Personal interests in certain processes, lack of experience on what is key for the analysed process or system, no consideration of available experience elsewhere (e.g. as condensed in appropriate and high quality Product Category Rules (PCRs)), getting lost in the many options for substitution and allocation without checking whether it matters from the system's perspective, and many other reasons lead to using up the available time and resources to collect lots of detailed and accurate data for processes or flows that contribute little to the total. At the same time, rough estimate data or gaps remain unsolved for main contributing processes and flows. Efficient and effective good practice in data collection requires to focus on what matters.

At the same time it should be warned to not entirely rely on existing experience and PCRs, as those sources may have often drawn on other existing experience and so on, without necessarily verifying what else matters. Using high quality experience is necessary, as well as making sure that the experience actually reflects the analysed situation and the specific process or system studied.

Also the often found entire reliance on readily available background from third-parties, as e.g. included in LCA software (not checking for quality or data gaps in those data, where other third-party data may be needed) contribute to the lack of quality of the results and robustness of conclusions. It is recommended therefore to always foresee that high quality data may have to be also specifically collected or obtained also for key background processes.

The following steps are recommended for systematically and efficiently determining quality requirements on LCI data. Unless the quality requirements are defined directly in the goal, this is done only after the first loop of data collection, results calculation, impact assessment, the identification of significant issues, and the evaluation. The requirements may need to be fine-tuned / adjusted in subsequent loops:

- For the identification of quantitative LCI data quality needs, determine / estimate the accuracy, completeness and precision of the LCIA results that is required by the intended application, e.g. to allow identifying significant differences among compared alternative products.
- Translate these requirements to related requirements at the level of elementary flows by taking into account the impact potentials of the individual elementary flows and by disregarding the uncertainties / inaccuracies associated with the characterisation factors.
- Based on the above, use the requirements on the elementary flows to determine the maximum permissible uncertainties, inaccuracies and incompleteness of the overall inventory of the to-be-collected or purchased processes' or systems' inventories. Note that this includes systematic uncertainties from LCI methods and models applied in the system and from assumptions made when setting up the system (e.g. product life cycle model).
- Use this information as indicative guidance on quality requirements in the collection or purchase of inventory data (i.e. unit process or LCI results and similar data sets). For third-party LCI data sets it is recommended to consider the following additional quality aspects: appropriate documentation, the use of compatible elementary flows and nomenclature, methodological consistency, and (potentially) a qualified external review.

### Provisions: 7.3 Planning data collection

Differentiated for attributional and consequential modelling.

Fully applicable to all types of deliverables, implicitly differentiated.

- I) **SHALL - Identify newly required, study-specific unit processes:** Identify for which processes of the analysed system new, study-specific unit processes have to be developed with producer or operator specific primary and secondary data. This is typically the case for the entire foreground system (including for those parts of existing or planned contractual relationships). The use of technical process or flow diagrams is recommended. (7.3.2)
- II) **SHALL - Average and generic data:** Identify for which parts of the analysed system the use of average or generic LCI data sets is more appropriate. Note that for a given case, average or generic data may be more accurate, complete and precise also for some processes of the foreground system. If such will be used, this shall be justified. (7.3.2)



Note that in case only a single unit process is the deliverable of the LCI study, only data for that process are to be collected, of course, and the provisions apply analogously.

- III) **MAY - Identify data and information sources:** It is recommended to systematically identify sources for the required data and information. This includes considering working for the background system primarily with LCI results or with unit process data sets, which both have advantages and disadvantages that are for the given case to be evaluated. Combinations are possible if the data is consistent. Among the LCI data sources, primary and secondary sources can be differentiated. Guiding principle should be the availability and quality of the most appropriate data. Working with well documented and already reviewed data sets is recommended. This supports a correct use of the data sets, a sound documentation of the analysed system, and its review. (7.3.3, 7.3.5) [ISO+]
- IV) **MAY - SI units:** It is recommended to aim at collecting data in the *Système international d'unités* (SI) units, to minimise conversion efforts and potential errors. [ISO+]
- Note that SI units shall be used for reporting (see chapter 10.2).
- V) **SHOULD - Multi-annual or generic data to be preferred?:** Evaluate along the goal of the study whether multi-annual average data or generic data should be preferred over annual average data as better representing the process / system. This applies for processes with strong inter-annual variations (e.g. agriculture; producer-specific data in general), to ensure sufficient time-related representativeness. (7.3.4) [ISO+]
- VI) **MAY - Relevance-steered data collection:** It is recommended to steer the effort for data collection by the relevance of the respective data and information. Building on existing experience that sufficiently reflects the analysed process or system and that is of high quality is an essential guide. Product Category Rules (PCR) and product-group specific guidance documents can represent this experience. The following is meant to help focussing data collection efforts. The initial data quality and data set quality requirements as identified in 6.9.2 may need to be fine-tuned / adjusted in subsequent loops as follows (but see also chapter 4) (7.3.6): [ISO+]
- VI.a) For the identification of quantitative LCI data quality needs, determine / estimate the accuracy, completeness and precision of the LCIA results that is required by the intended application (e.g. to allow identifying significant differences among compared alternative products).
- VI.b) Translate these requirements to related requirements at the level of elementary flows by taking into account the impact potentials of the individual elementary flows and by disregarding the uncertainties / inaccuracies associated with the characterisation factors.
- VI.c) Use these requirements on the elementary flows to determine the maximum permissible uncertainty, inaccuracy and incompleteness of the overall inventory of the to-be-collected or purchased processes' or systems' inventories.
- Note that this includes systematic uncertainties from LCI methods and models applied and from assumptions made when setting up the system model.
- VI.d) Use this information as indicative guidance on quality requirements in the collection or purchase of inventory data (i.e. unit process or LCI results and similar data sets). For secondary LCI data sets it is recommended to consider the following additional quality aspects: appropriate documentation, the use of compatible elementary flows and nomenclature, methodological consistency, and

a completed qualified external review.

Note that in case the later collected or purchased data sets do not meet the requirements, the results of the study may not meet the overall consistency, quality and review requirements.

Note that all publicly accessible data sources shall later be referenced.

Various descriptive information shall later be provided for all significant data, such as the data collection process, the age of the data and data quality indicators.

## 7.4 Collecting unit process LCI data

(Refers to ISO 14044:2006 chapter 4.3.2 and aspects of 4.3.3)

### 7.4.1 Introduction and overview

(Refers to aspects of ISO 14044:2006 chapter 4.3.2.1)

#### Introduction

For all processes that have been identified (see chapters 7.2.3 or 7.2.4), the inventory data have to be collected. An actual collection of inventory data is typically only required for the foreground system, provided all data in the background system can be sourced from available background databases.

Unit process data are at the basis of all LCI work. The provisions for their collection are essentially the same for attributional and consequential LCI modelling.

Ideally they relate to a single operation unit process of a specific process (e.g. bulk goods transport performed by a specific 7.5 t truck model). This is what this chapter relates too.

However they can also refer to an averaged mix of processes (e.g. market mix of bulk goods transport by all the specific brands of EURO 4, 7.5 t trucks in Germany). This builds on this chapter, with the averaging being addressed in the later chapter 7.7.

Or they can be generic in nature and hence depict a process or technology in general rather than its operation in a specific or average way (e.g. market mix of the same truck type as before, but obtained generically instead of averaging data of the specific truck models, which might not be available). Development of generic data sets is addressed in the later chapter 7.5, with many provisions of this chapter to be applied as well.

All these data set types can include parameterisation, yielding technology models as parameterised unit process. Note that all of these can also refer to a set of interconnected single-operation unit processes (e.g. a plant or whole site), i.e. be a black box unit process for which the inventory data is collected<sup>136</sup>. For this mostly the same provisions apply as for single operation unit processes. Which of these forms of unit processes is used depends on a range of issues. These include:

- goal and scope of the study (especially type of process / system analysed, intended applications),
- data availability and quality, and

<sup>136</sup> Note that unless explicitly aim of the study, the collection of single operation unit processes should be aimed at and the collection of black box unit processes should be avoided. Black box unit processes cause difficulties to review and often in addition multifunctionality problems. The latter require extra information and effort to be solved and in any case distort the results to some degree. If during data planning or raw data collection a process turns out to be a black box unit process, one should check whether it can be split by subdivision before data collection or virtual subdivision afterwards.

- available resources (finance, experts).

## Overview

This chapter starts with the main guidance on the initial step of collecting raw data towards obtaining unit processes (7.4.2). This includes the important step of interim quality control and dealing with missing data.

The next two subchapters give provisions on a range of methodological issues for elementary flows (7.4.3) and specific process types (7.4.4).

The last subchapter 7.4.5 details conventions in naming and other aspects.

A more tailor-made, but also much more condensed, technical guidance on the development of LCI data set is given in the separate guidance documents on “Specific guidance document for LCI data sets”. That document builds on the "Provisions" of this general guidance and focuses on the relevant items for LCI data set development.

## 7.4.2 Basic data collection towards unit processes

(Refers to aspects of ISO 14044:2006 chapter 4.3.2.2. and 4.3.3)

### 7.4.2.1 Introduction and overview

(Refers to aspects of ISO 14044:2006 chapter 4.3.2.2. and 4.3.3)

Before providing the overarching methodological provisions and nomenclature and other conventions to be applied to processes and flows, in this chapter the provisions and recommendations are given on the basic collection of raw data<sup>137</sup> and the way towards unit process inventories:

- Avoiding black box unit processes by subdivision or virtual subdivision (7.4.2.2)
- Describing what the unit process represents (7.4.2.3)
- Types of input and output flows to collect (7.4.2.4)
- Data and information types for specific, future and generic data sets (7.4.2.5)
- Reference amount of the reference flow (7.4.2.6)
- Representativeness regarding operation conditions (7.4.2.7)
- Checking legal limits (7.4.2.8)
- From raw data to unit process inventory per reference flow (7.4.2.9)
- Solving confidentiality issues (7.4.2.10)
- Interim quality control (7.4.2.11) , and as an important aspect of this
- Dealing with finally missing inventory data (7.4.2.11.3)

---

<sup>137</sup> A more comprehensive guidance and an approach for systematic documentation of this basic step could be a future work.

## 7.4.2.2 Avoiding black box unit processes by subdivision and virtual subdivision

(Refers to aspects of ISO 14044:2006 chapter 4.3.4.2)

### General approach

If the unit process for which data will be collected is a combination of more than one, physically separate process steps, this is a black box unit process; see Figure 8.

Black box unit processes can cause difficulties to review. This is the case especially if the process is developed as generic process (see chapter 7.5) and the reviewer would be better able to judge on the level of the single process steps than on an integrated chain of steps. On the other hand and especially for specific data that is based on measurements, the review can well be done on basis of the measured data; subdivision does not help in that case.

At the same time, black box unit processes often cause multifunctionality problems. These require extra information and effort to be solved and in any case distort the results to some degree. If subdividing a multifunctional black box unit process can solve the multifunctionality, this is to be preferred.

Subdivided process chains may also be required by the specific application, e.g. a detailed weak-point analysis or ecodesign purpose is more interested in the single contributors and how to reduce their impact than on the value of the absolute, overall results.

In summary: if during data planning or raw data collection a process turns out to be a black box unit process, one should check whether the process can be split by subdivision and whether that would ease review, improve accuracy and applicability, and avoid multifunctionality.

Subdivision is generally done before data collection or virtual subdivision afterwards.

### Subdivision

First choice is to subdivide the concerned black box unit process into its included processes.

This subdivision is performed prior to the final raw data collection. The relevant inventory data is collected separately and only for those of the included unit processes that relate to the analysed system. An example is an assembly hall, where data on electricity, consumables and parts consumption would be collected separately for the different production lines as single operation unit processes. The data on the hall itself, the heating, lighting etc. would also be collected separately as single operation unit processes, while being multifunctional processes, as they serve all production lines.

Subdivision is especially important if the black box unit process provides more than one function, i.e. is multifunctional and the resulting single processes are all mono-functional.. If it is theoretically possible in this way to separate the delivery of the targeted good or service from that of the co-function(s), subdivision and sometimes virtual subdivision (see below) are the only approaches that can provide accurate data. In the preceding example this is not possible, as e.g. the hall and the hall heating cannot be modelled separately for the contained lines. Still, the split has probably substantially improved the data accuracy.

### Partial subdivision

If it is not possible to split the black box entirely, a partial subdivision should nevertheless be done. Partial subdivision can lead to two types of results:

- one or more included processes are singled out as single operation unit processes and one or more included processes are still black box unit processes (e.g. in an integrated site for production of the analysed system Melamine, the included Ammonia production plant and the Carbon dioxide co-product separation and compression can be singled out as separate single operation unit processes, while the Urea and Melamine production plants data are available only jointly.)
- only some information can be singled out separately for the analysed function but one or more of the included processes are only partly split up, i.e. the "split" is cutting through a single process step. Note that under consequential modelling this form of partial splitting of processes can result in distortions when later substitution is used to separate the processes of the analysed function entirely. Under attributional modelling this form is appropriate.

### Virtual subdivision

There are different possibilities for obtaining the inventory data of the included unit processes: actual data collection (preferable option) and – in many but not all cases – the use of knowledge about the involved processes: This can be the basis to split up the data of the multifunctional process and assign the inventory items to the included unit processes. Such knowledge can e.g. be the simple understanding that emissions to water can only come from the processes that contribute waste water, that certain parts or consumables are only required as input for certain processes, and the like.

In some cases, the assignment and virtual subdivision is qualitatively and quantitatively clear and exact, as in the above example. In other cases the subdivision needs to draw on expert judgement and will not be exact while still improving the data quality. E.g. in a manufacturing line several electricity consuming steps might be metered jointly. Along other machine information (e.g. nominal power uptake, load factor, and running time) it may be possible to sufficiently accurately virtually subdivide the black box to the single process steps, even though not exactly.

This way, qualitative production / operation system information can be sufficient to subdivide the black box partly and in some cases even entirely and correctly assign all or most of the quantitative information to the single included unit processes.

Also in those cases where this "virtual subdivision" cannot provide all single data values, it will often significantly lower the effort, as only remaining missing data needs to be directly collected for the individual included processes.

However, note that virtual subdivision can be applied in consequential modelling only if it results in complete separation of the inventory of the analysed function; otherwise the substitution would be distorted.

From the perspective of the resulting data sets, virtual subdivision can mean to either generate more than one unit process from the black box data. Or - relevant for black box unit processes that cannot be entirely virtually subdivided but it cuts through the process - the process is not split into more than one, but the subdividable single inventory flows are assigned entirely or partly to the corresponding co-function.

Virtual subdivision can also in principle be applied to physically not subdividable processes: in a chemical reactor, organic compounds may be chlorinated with Chlorine, resulting in different co-products with one, two and three chlorine groups. The total amount of Chlorine consumed in the reactions as reactant can be assigned to the co-products in proportion to the amount of Chlorine they have bound. This is also an example of partial subdivision that cuts through the single process step. Note that in this example any surplus of Chlorine and any Chlorine emissions require a separate and typically different approach

for solving the multifunctionality. It is reiterated that "cutting" through not further subdividable joint processes, as done in this example, shall not be applied in consequential modelling / substitution as the results would be distorted.

Note that virtual subdivision is equivalent to identifying and using the determining physical causality as allocation principle, i.e. of depicting the quantitative inner relationships between the non-functional flows and the co-functions.

### Provisions: 7.4.2.2 Avoiding black box unit processes by subdivision and virtual subdivision

Differentiated for attributional and consequential modelling.

Note that these provisions are to be applied to each unit process separately, in case more than one is modelled (e.g. in the foreground system of an analysed system).

- I) **SHOULD - Multifunctionality solvable by subdivision?:** Investigate whether the analysed unit process is a black box unit process (concept see Figure 7): does it contain other physically distinguishable sub-process steps and is it theoretically possible to collect data exclusively for those sub-processes? Next, check whether subdivision can solve the multifunctionality of this black box unit process: can a process-chain within the initial black box unit process be identified and modelled separately - preferably process step by process step - that provides only the one required functional output?
- II) **SHOULD - Based on the outcome, the following steps should be followed:**
  - II.a) **If possible subdivide:** If it is possible to collect data exclusively for those included processes that have only the one, required functional output: inventory data should be collected only for those included unit processes, i.e. subdivision be performed.
  - II.b) **If not possible, partially subdivide:** If this is not possible (i.e. the analysed unit process contains multifunctional single operation unit processes that are attributed to the required functional output) or not feasible (e.g. for lack of data access or for cost reasons): inventory data should be collected separately for at least some of the included unit processes, especially for those that are main contributors to the inventory and that cannot otherwise (e.g. by virtual subdivision - see more below) clearly be assigned to only one of the co-functions. [ISO+]
  - II.c) **If also not possible, virtually (fully or partly) subdivide:** If neither subdivision nor partial subdivision is possible or feasible, it should be checked whether it is possible by reasoning to virtually partly or fully sub-divide the multifunctional process based on process/technology understanding. This is the case wherever a quantitative relationship can be identified and specified that exactly relates the types and amounts of a flow with at least one of the co-functions / reference flow(s) (e.g. the specific mechanical parts or auxiliary materials in a manufacturing plant that are only used for the analysed product can be clearly assigned to that product by subdividing the collected data). For those processes where this can be done, a virtual subdivision should be done, separating included processes as own unit processes without separate data collection. [ISO+]

Note that under attributional modelling, singling out required process steps from a black box unit process by virtual subdivision can also improve the basis for a subsequent allocation, with more accurate results.

Note that virtual subdivision is applying the same logic as the physical causality as allocation principle, i.e. of depicting the quantitative inner relationships between the non-functional flows and the co-functions.

Note that under consequential modelling, actual or virtual partial subdivision within processes results in distortions in case substitution would later be used to separate entirely the analysed function.

- III) **MAY - Other reasons to subdivide / virtually subdivide?:** If according to the initial step of these "Provisions" the unit process is a black box but is not multifunctional, check whether it would improve the reviewability of the data or whether it is required for the intended applications to subdivide or virtually subdivide the process. If so, it is recommended to fully or partly subdivide or virtually subdivide the process. [ISO+]

### 7.4.2.3 Describing what the modelled unit process represents

(Refers to aspects of ISO 14044:2006 chapter 4.3.2.2)

Starting from the identification and possibly initial description of the required process (chapter 7.2), describe the actually modelled process in more detail: This includes information of its actual technological, geographical and time-related representativeness and especially the functional unit(s) and reference flow(s), and other quantitative and qualitative information.

This information helps in preparation of the actual inventory data collection and quality control. During data collection, quality control etc. it will be fine-tuned towards obtaining the required description and specification of the final process as it has been modelled.

#### **Frequent errors: Misleading description beyond what is represented by the actual data**

It can be quite often found that published data sets do not describe what they actually represent (i.e. based on the used data), but what they were intended or are meant to represent.

E.g. may the data reflect a single technology, but the data set in such cases is claimed to represent a market mix. Or the data is directly derived from a research study or lab data, theoretical models etc., but is described as being a representative industry process, reflecting average operation at a large scale.

This must be avoided by clearly stating what the data set represents. It can of course be that a data set is to some degree representing e.g. a market mix, even though it does not cover all technologies, routes, etc., but this is to be clarified in a prominent place: If combining data from different sources or having otherwise lack of representativeness, this shall be stated in the data set and any accompanying documentation, if published.

Note that at the end of the data collection the final documentation of this meta data is to be completed, e.g. naming operating conditions, assumptions made, use of data from other sources, data gaps, achieved completeness and precision of the inventory, etc. Details on documentation are given in chapter 10.

#### **Provisions: 7.4.2.3 Describing what the unit process represents**

Note that these provisions are to be applied to each unit process separately, in case more than one is modelled (e.g. in the foreground system of an analysed system).

- I) **SHALL - Characterise the unit process:**
- I.a) **Representativeness:** Characterise the unit process regarding the technology /

technique, geographical / market scope, and the time (e.g. year, plus seasonal / diurnal differentiation, if applicable) it represents and any possibly limited representativeness. This characterisation includes identifying the relevant operating conditions and/or other factors influencing its inputs and outputs to a relevant degree. See chapter 6.8 for details.

- I.b) **Reference flow(s) / functional unit(s):** If the deliverable is an LCI study or data set, one or more reference flows are the key identifiers and quantitative reference of the life cycle inventory and documentation. Determine and name the reference flow(s) as the amount of product(s) of the system that provide the function as specified in the functional unit. For recommendations on product flow naming see document "Nomenclature and other conventions". Also the functional unit(s) should be specified if appropriate and/or technical specifications be given (provisions for different process / system types see chapter 6.4.6). [ISO+]

Note that a variety of meta data about the process and/or its product(s) is later to be provided to the user and reviewer, e.g. on its technical applicability, method assumptions, who has modelled it, etc. It is recommended to ensure proper documentation already on level of the single unit process, also if the deliverable is an LCI result or LCA study, by using the ILCD data set format (see also chapter 10 on "Reporting").

#### 7.4.2.4 Types of input and output flows to collect

(Refers to aspects of ISO 14044:2006 chapter 4.3.2.3)

##### Types of flows

The final unit process inventory lists input and output flows. These are based on various kinds of data and information and only seldom the collected data can directly be inventoried. This chapter identifies first what is the kind of flows that finally will be found in the inventory, as guidance for orientation:

Process inventory data is collected or modelled on input side and output side.

Input side flows include elementary flows such as material and energy resources, land use, product flows such as energy carriers, chemicals and materials, consumables, parts and components, semi-finished products, complex products, and services of all kind, and.

Output side flows include – next to the one or more product(s) - generated waste, emissions to air, water and soil, and other environmental aspects that may be of relevance for the impact assessment (e.g. noise, nature littering, etc.) and for the given case.

Specifically for waste management processes, waste flows will additionally occur on the input side; see chapter 7.4.4.2.

The Provisions list the types of flows systematically.

##### Provisions: 7.4.2.4 Types of input and output flows to collect

- I) **SHALL - Types of input and output flows:** Quantitative data of all relevant<sup>138</sup> inputs and outputs that are associated with the unit process shall be collected /modelled, as far as possible. Where not possible, the gap shall be documented and if they cannot be overcome be considered when reporting the achieved data quality and when interpreting results of a study. These flows typically include, if relevant for the modelled

<sup>138</sup> See Action on "applying cut-off rules" more below in this chapter.



process / system:

- I.a) Input of “consumed” products (i.e. materials, services, parts, complex goods, consumables, etc.), as product flows.
- I.b) Input of wastes (only in case of waste servicing processes), as waste flows.
- I.c) Input of resources from nature (i.e. from ground, water, air, biosphere, land, etc. and with possible further sub-compartment specifications as required by the impact assessment methodology to be applied), as elementary flows.
- I.d) Emissions to air, water, and soil (with possible further sub-compartment specifications as required by the impact assessment methodology to be applied), as elementary flows
- I.e) Other input and output side interventions with the ecosphere (if required by the applied LCIA methods), as elementary flows.
- I.f) Output of wastes (e.g. solid, liquid, gaseous waste for waste management within the technosphere<sup>139</sup>), as waste flows.
- I.g) Output of valuable goods and services provided by the process, as product flows.

#### 7.4.2.5 Data and information types for specific, future and generic data sets

(Refers to aspects of ISO 14044:2006 chapter 4.3.2.2. and 4.3.3)

##### **Specific data collection - measurements and tailored questionnaires**

The most representative sources of data for specific processes are measurements directly performed on the process, or obtained from operators by interviews or questionnaires (see more below in this chapter).

Seldomly the data can directly be inventoried, but it needs scaling, aggregation or other forms of mathematical treatment to bring them in relation to the process' functional unit(s) and/or reference flow(s). This is addressed in chapter 7.4.2.9.

Among others the following types of directly or indirectly measured data and information can be differentiated for existing processes and products:

- process or plant level consumption data
- bills and stock/inventory-changes of consumables
- emission measurements (concentrations plus corresponding off-gas and wastewater amounts)
- composition of waste and products, especially the elementary composition and energy content in support of element and energy balances that support quality control and quality improvement (cut-off)

##### **Further data sources for specific processes**

Next to measurements, it is typically helpful (also for cross-checks) or even necessary (to fill gaps) to draw on other data sources. These include:

<sup>139</sup> The emissions resulting from waste that is directly discarded into the environment shall be modelled as part of the LCI model, with the processes considered to be part of the technosphere (details see chapter 7.4.4.2).

- recipes and formulations,
- part lists,
- patents,
- process engineering models,
- stoichiometric models,
- process and product specifications and testing reports,
- legal limits,
- data of similar processes, and
- BAT reference documents.

For future processes and for generic data sets, data and information on existing processes and on models of the future or generic processes need to be used jointly.

### **Future processes - models, foresight, lab data**

For future processes this will be more on the side of models, drawing on all kinds of available data and information, including e.g.:

- process modelling or planning,
- patents,
- lab data or pilot plant data,
- data of existing, similar technologies / techniques,
- BAT reference documents, and again
- legal limits.

### **Generic data - process and system characteristics**

For generic data sets technical characteristics of the to-be-modelled processes can often be measured and then averaged towards getting representative parameters for the generic model. Such technical characteristics can be e.g.

- principle list of relevant flows of the process or e.g. bill of material and processing level of the good,
- efficiency ratios of e.g. energy conversion or yield,
- stoichiometric and other physical limits to the range of flow-amount ratios,
- ranges of existing technologies / techniques, and again
- BAT reference documents, and
- legal limits.

On the development of generic processes see 7.5.

### **Use stage and initial waste management data of consumer products**

In the case – depending on the goal of the study – also the use stage and initial waste management of a consumer product (either by final consumers or by a service operator) is included in the system boundaries, the data collection faces different challenges than for production processes:

In difference to production processes, the way how the product is used is often much less homogeneous and much less well-defined. Very different use scenarios exist. At the same time, consumer products often have an important use stage when they perform their function, e.g. by consuming energy ("energy-using products"), by being related to energy-consumption ("energy related products"), or by having other relevant characteristics (e.g. being potentially problematic regarding initial waste management by the consumer such as waste separation questions, discharge via toilet, etc.). This affects in a similar degree processes operated at final consumers and as supporting processing in business.

Another example - also related to the use stage of products but less obvious - is the use of personal consumer products such as clothes, watches, mobile phones, laptops, and the like: many of them are transported during their use stage, e.g. by car, train, or plane. Their weight, the related fuel consumption, emissions, etc. should be considered in principle, if quantitatively relevant and using e.g. an average or typical transport situation.

The data for these steps can in addition to measurements and technical specifications from the producer come from surveys that aim at identifying the representative average or typical user behaviour. This often requires different forms of data collection.

### Questionnaires and other means to collect data

For the data collection, it is recommended to use tailor-made data collection sheets together with specific (e.g. technical) flow charts to ensure proper inventorying and documentation already on level of the single unit processes. The initial and fine-tuned flow charts that were prepared in context of the scope definition and when identifying to-be-included processes are useful for this purpose. During data collection and iterative with feedback from the process operator they may be revised to better capture the respective process(es).

It is recommended to depict in these flow-charts the level of the desired detail, e.g. single-operation unit processes and not on the aggregated level of black box unit processes. This supports decisions on the eventual need for subdivision of multifunctional processes and the review of the inventory.

#### Provisions: 7.4.2.5 Data and information types for specific, future and generic data sets

- I) **SHOULD - Raw data types:** Raw data types that should be used for the process, as required: [ISO+]
  - I.a) **Measured data** collected by/at process operators should be preferred if possible and appropriate. Measurements are not only physical measurements of e.g. emissions but also other specific information for the operated process such as e.g. bills and consumption lists, stock/inventory changes, and similar.
  - I.b) **Element composition and energy content** of product and waste flows. This data should later be inventoried as flow property information for these flows to support interim quality control, review, and improving data quality.
  - I.c) **Various other data** can be helpful (also for cross-checks) or even necessary (to fill gaps). These are e.g. recipes and formulations, part lists, patents, process engineering models, stoichiometric models, process and product specifications and testing reports, legal limits, market shares and sizes, data of similar processes, BAT reference documents, etc.

I.d) **Use stage information:** For modelling the use stage of consumer products and initial waste management, it is recommended to use surveys and studies that analyse the average or typical user behaviour to complement product specifications and user manuals. Information provided in product category rules (PCR) can be supporting.

II) **MAY - Tailor-made data collection forms:** It is recommended to use tailor-made data collection forms together with technical flow charts. Specific data collection forms are recommended over generic forms. [ISO+]

### 7.4.2.6 Reference amount of the reference flow

(Refers to aspects of ISO 14044:2006 chapter 4.3.3)

The individual data for the inventory must each be quantitatively expressed as flows per functional unit (e.g. the mass of carbon dioxide that is emitted to air in relation to the reference flow of the system, e.g. 1 MJ lower calorific value heat generated in case of a water boiler).

In attributional modelling, the inventories and the model are linearly to the amount of function, i.e. it does not matter whether 1 kg copper wire is used or 100,000 t.

In consequential modelling however, the amount of the required or provided function influences whether a small-scale or large-scale situation exists. In modelling of Situation B (see chapter 5.3) it depends on the actual amount in relation to the market size whether large-scale consequences can be assumed to occur. To ease the identification of those processes where this applies, it is therefore recommended to check the amount in context of the system model, e.g. by scaling the model to the total scale of the analysed process in the foreground system. Together with the information of the market size, that is recommended to be documented in any process data set for use in consequential modelling, it can be easily checked - starting from the foreground process and going stepwise into the background system - which processes are affected.

To ease reporting, reading, reviewing and jointly using inventory data from different data providers, a convention for the selection of these reference flow properties and reference units is helpful: Unless explicitly differently set by the goal of the study, it is recommended to express the inventory always in relation to "1 unit" of the function of the process / system (e.g. 1 kg "Copper wire XY standard; 0.1 mm"), using the flow properties and reference units as defined in the already named document "Nomenclature and other conventions" (see also chapter 7.4.5). This is unless a different unit (e.g. one year of production) is explicitly required for the intended applications. If there is more than one function, only one of them can be set to "1 unit" and the other in proportion, of course.

#### Provisions: 7.4.2.6 Reference amount of the reference flow

Differentiated applicability to Situations A, B, and C.

Differentiated for attributional and consequential modelling.

Differentiated applicable for different types of deliverables.

Note that these provisions are to be applied to each unit process separately, in case more than one is modelled (e.g. in the foreground system of an analysed system).

I) **MAY - "1 reference unit" for the reference flow:** It is recommended to use the amount of "1 reference unit" of the reference flow (e.g. "1 kg" Copper wire...) and to

express the inventory of the process in relation to this amount. This is unless a different amount would be required for the intended application (e.g. "1 year of production" of a site). [ISO+]

- II) **SHALL - Document absolute amount of the central process:** For LCA studies under Situation A and B, the absolute amount of the central process in the foreground system shall be documented. The total market size of the function of this process shall be documented. This shall be done with the sufficient precision to later check whether the product or waste flows that link the foreground with the background system and potentially further process steps in the background system or any multi-functional foreground processes need to be modelled under Situation B, i.e. whether the analysed decision has large-scale consequences beyond the foreground system. [ISO+]

### 7.4.2.7 Representativeness regarding operation conditions

(Refers to aspects of ISO 14044:2006 chapter 4.2.3.6.2)

#### General

The representativeness regarding operating conditions is part of the technological representativeness: The collection of inventory data is to take into account the full cycle of the process, i.e. in addition to the actual operation of the process also e.g. start, closure, and eventual stand-by times. It may well be that under these special operation conditions, which may not be seen as directly contributing the system, a large share of the emissions occurs.

The above applies unless the data set is meant to represent only a partial cycle.

The provisions apply analogously to services, i.e. preparation of the work, performing the service, stand-by/waiting times, after-service activities such as e.g. cleaning of the equipment, performing warranty activities, etc.

In order to get a representative impression of the inputs and outputs associated with the process, they should be quantified for a running time of the process that covers at least one full cycle. The results are then divided by the functional output of the process during this time, hereby directly expressing it in unit process form.

For operating plants it is recommended (also in ISO 14044:2006) to use one full year as data basis, to capture these are other issues.

#### Parameterised processes

Data used for developing the formulas of for parameterised processes should cover all relevant technical and management aspects of the to-be-represented process. In principle all these variables that relate one or typically several inputs and outputs to them (or to other inputs and outputs) needs to be covered and expressed in mathematical relations.

These variables and the parameters that will later be used to adjust the process to represent the specific way the process is run can be e.g. load-dependent yield and consumption of consumables, input-composition dependent emissions, yield-dependent consumption of products, collection and recycling rates, and many others.

#### Provisions: 7.4.2.7 Representativeness regarding operation conditions

Note that these provisions are to be applied to each unit process separately, in case more than one is modelled (e.g. in the foreground system of an analysed system).

- I) **SHALL - Full operational cycle of the process, if required:** The collected inventory

data for a specific process shall as far as possible and required to meet the goal represent the full operational cycle of the process. This includes all quantitatively relevant steps such as e.g. preparation, start, operation, closure, stand-by and cleaning as well as maintenance and repair of the process / system and under normal and abnormal operating conditions. This is unless the data set is meant to represent only a partial cycle. The above applies analogously also to services. The achieved representativeness of the data shall be documented.

- II) **SHOULD - One full year as data basis:** For measured data of operated processes, data for at least one full year should be used as basis for deriving representative average data. A sufficient number of samples should be taken and the uncertainty be considered when reporting the precision.
- III) **SHOULD - For parameterised processes:** The mathematical relations should represent the relevant changes of the inventory in dependency of the influential parameters, which can be e.g. technical, management, or others. This can include quantitative and qualitative relationships between inventory flows. [ISO+]

Note that the mathematical model and its relevant assumptions and limitations later will need to be documented as well.

### 7.4.2.8 Checking legal limits

(No corresponding ISO 14044:2006 chapter)

It is additionally advisable to refer to legal limits and reporting obligations that exist for the analysed process or the sector in which the process is operated (or relates to). All emissions that are specifically regulated should be checked for relevance and – if given – be quantified and reported in the inventory. However, to avoid later questions it is advised to report regulated emissions also in case they are not relevant for the LCIA results. In the case the country where the process is operated does not have legal limits or these are very limited in international comparison, it is advisable to identify the inventory items for which legal limits exist in other countries with stricter legislation (e.g. Japan, the EU, or the USA).

The values that are set for legal limits can also be used to check whether the measured data is plausible, and in some cases legal limit values can – after scaling them in relation to the reference flow – also be used as worst case estimate. This is however only feasible if the legal limits apply to the specific process and country where it is operated and if compliance with these limit values is actually controlled and enforced.

The default use of legal limits for the inventory is not appropriate, unless this is checked and justified for applicability in the analysed process and specific situation.

#### Provisions: 7.4.2.8 Checking legal limits

Limited applicability for future processes beyond some years from present.

Note that these provisions are to be applied to each unit process separately, in case more than one is modelled (e.g. in the foreground system of an analysed system).

- I) **MAY - Check legal limits:** It is recommended to check for the existence of relevant legal limits as guidance on which flows to in any case include. One may use existing legal limits of e.g. Japan, the EU, the US in case of limited environmental legislation in the country where the process is operated and as far as the limits are technically transferable. If the legal limits apply in the country / market in which the represented

process is operated and are also enforced, they give an indication of the possible maximum values of the amounts of these flows. [ISO+]

Note that legal limit values - also of the country where they originally apply - normally cannot be used as inventory values, unless this is checked and justified for the modelled process and in line with the goal.

### 7.4.2.9 From raw data to unit process inventory

(Refers to aspects of ISO 14044:2006 chapter 4.3.3)

The amount of products produced by a production unit process (or of functions performed in case of services) is required in order to relate the emissions and other flows to the functional unit and reference flow of this unit process. In data collection often accounts are available that report the total annual load of emissions and consumption of fuels, materials and ancillary chemicals of a process or a plant. These annual account figures must be quantitatively related to the amount of goods or services provided during the period which is covered by the account.

#### **Frequent errors: Un-reflected use of machine specifications**

A very common error, which is difficult to detect in review, is to model the performance of a process based on some theory on how it operates and not verifying this with data from the process in real operation. For electrical equipment, sometimes the specified maximum power consumption (e.g. “10 kW”) is used, implicitly assuming to be the average consumption. This does not consider that the equipment is not running all the time and that when it runs it typically is running not on maximum load.

In other cases of collecting the raw data, only concentration measurements for emissions are available. This applies e.g. to flue gas concentrations of priority air pollutants as required by legal authorities, to concentrations of specific pollutants in wastewater discharges, but also to product concentrations measurements in continuous processing operations. In order to be of use in the data compilation for the inventory, concentrations must be translated to mass flows, and this requires information about the volume of the e.g. flue gas, wastewater, product flow in which the concentration is measured. To relate the resulting numbers correctly to the reference flow, in a second step they must be scaled to the amount of product(s) of the process.

Errors in this scaling including when converting additionally between units (e.g. from “ng/m<sup>3</sup>” to “kg”) can often be observed and must be carefully avoided. This is best done by documenting all the calculation steps from the raw data to the final inventory data e.g. in one spreadsheet. This also eases interim quality control, review, and later updating of the data set.

#### **Frequent errors: Unit conversion errors**

Unit conversion errors resulting in values being in the range of 1,000 or more too large (e.g. when interpreting kg instead of g or mg) are easily detected. In the other direction, e.g. erroneously downscaling an e.g. PAH emission by a factor 1,000 or more is very difficult to detect as it does not peak out in the inventory analysis. Such cases need deeper expert inside to be observed as conspicuously low numbers.

Even worst are errors of below one order of magnitude, as they can much easier pass unnoticed, while still rendering the data and conclusions invalid. One potential source for such errors is the use of the “.” and the “,” for decimal separator that is handled differently in different regions and countries.

Other unit conversion errors relate to using different unit systems (e.g. Imperial system to SI).

Per default the SI units shall be used for reporting, while - depending on data availability - other units will be necessarily used when collecting raw data.

### Provisions: 7.4.2.9 From raw data to unit process inventory

Note that these provisions are to be applied to each unit process separately, in case more than one is modelled (e.g. in the foreground system of an analysed system).

- I) **SHALL - Correct scaling to the functional unit(s) / reference flow(s):** Correct scaling to the functional unit(s) / reference flow(s) shall be ensured when converting the raw data to inventory flows.

Note that the e.g. measured concentrations, annual numbers, relative stoichiometric data, yield percentages, etc. usually need to be mathematically processed to correctly relate to the functional unit of the unit process.

- II) **MAY - Documentation of all steps:** It is recommended to document all data treatment steps from the raw data to the inventory flows of the unit process, such as averaging/aggregation, scaling, unit-conversion etc. This substantially facilitates the review process in case questions come up and it eases later updating of the data set. Details see chapter 10 on reporting. [ISO+]

### 7.4.2.10 Solving confidentiality issues

(Refers to aspect of ISO 14044:2006 chapter 5.2)

Confidentiality issues may occur in data collection and they need to be respected in view of protecting technology know-how and patent rights. Such issues occur both for the foreground system data of the process operator and its tier-one suppliers, but may also occur in background data in cases where there are only 1 or 2 producers in a country or region.

In all such cases special confidentiality agreements may be necessary for data collection and modelling, but also review. This may in extreme cases involve that the processes or system is modelled in-house and the external review is equally done in-site, i.e. without sending out the sensitive unit process information.

For publication purposes the use of (independently and externally reviewed) LCI result data sets (e.g. aggregated from cradle to gate) can in most cases fully address or sufficiently reduce the confidentiality concerns, as such data does not allow to derive sensitive details about the operations. To ensure the necessary transparency for review, confidential information can be documented in a separate "confidential report" that is made accessible only to the critical reviewers under confidentiality; see in chapter 10.3.4.

Similar confidentiality issues of protecting know-how and ownership exists for data developed e.g. by consultants and research groups as secondary data providers. Equally here an independent external review can assure that the claimed data quality has actually been achieved and is correctly documented.

### Provisions: 7.4.2.10 Solving confidentiality issues

- I) **MAY - Aggregation:** Confidential and proprietary information can be protected by aggregation to LCI results data set and partly terminated system data sets. [ISO+]
- II) **MAY - Confidential report:** Transparency can be ensured by documenting confidential



information in a separate "confidential report" that is made accessible only to the critical reviewers under confidentiality; see chapter 10.3.4.

### 7.4.2.11 Interim quality control for improving data quality

(Refers to aspects of ISO 14044:2006 chapters 4.3.3.2, 4.3.3.4 and in several other chapters)

#### 7.4.2.11.1 General approach

Quality control of the collected data on unit process as well as in the context of the system is an important part of data collection. The approaches that can be applied for this are the same as those foreseen for an external review and drawing on the procedures of chapter 9 on interpretation. While these steps are in principle the same as the ones taken at the end of each iterative round of doing the LCI / LCA study, they can be applied in a less extensive way and only drawing on their aspects. The interim quality control can hence include:

- identifying significant issues,
- completeness check,
- sensitivity check, and
- consistency check.

This way, the data sets' accuracy, completeness and precision can be improved already in parallel to data collection. This can limit the number of full iterative rounds needed to achieve the required or aimed at quality of the final results.

Drawing on these steps, the following can be checked in parallel to data collection and modelling:

- Does the unit process inventory include all relevant product, waste and elementary flows that would be expected based on e.g. the input of processed materials, of the nature of transformations occurring in the process, and/or based on experience gained with similar processes? When doing so, make sure to reflect the required technological, geographical and time-related representativeness.
- Are the amounts of the individual flows and of the chemical elements, energy and parts in the input and output in expected proportion to each other? There are often stoichiometric or other systematic relationships that can help to check whether measured data is plausible. Performing chemical element and energy balances, as well as cost balances between the input and the output of a unit process (and also LCI result) are key checks for improving data completeness, but also for identifying errors.
- Controls may also be based on impact assessment results that are calculated ad hoc for the process as well as for the whole system. They may reveal errors in the inventory results through showing unexpected high or low values of contributing elementary flows. It is also recommended to compare the LCIA results with data of the same or similar processes / systems from other sources to identify possible problems. However, this is only useful if the other sources are of high quality and especially high completeness. It must be avoided to assume completeness of a data set only because it includes all flows that are found in a similar process from another source.
- On the system level, carefully check that methods have been applied consistently. This especially applies if combining data from different sources. Both for the steps from raw data to unit processes, but also and especially for combining LCI result data sets in a life cycle model.

- Critically check the findings and aim at clearly qualitatively and quantitatively explaining any observed discrepancies in the inventory data. This can be done by consulting additional data sources or technical experts for the analysed process. They may also help to improve the data, at least qualitatively.
- It is recommended providing for each unit process data set an at least brief internal quality control report on the above findings. If the process is intended to support comparative assertions (e.g. as background data set) it shall be accompanied by a third-party report, as also required in ISO 14044.
- Finally, reflect the findings in the reported data set quality criteria. Make sure that the data set documentation appropriately describes the process and the finally achieved accuracy, precision, and completeness as well as any limitations.

#### **7.4.2.11.2 Obtaining better unit process data**

##### **Identify and prioritise the need for obtaining better data**

Based on the above steps and for any still missing data or quantitative information, the following is recommended:

To identify exactly which specific or higher quality data needs to be collected or obtained, for the initially missing data "reasonably worst case" flows and values would be used. These can be obtained via expert judgment. E.g. an unknown "metal" emission could be "Lead" and/or "Arsenic" in case of a lead-zinc-ore roasting process, a missing "unspecific polymer part" could be an "injection moulded ABS or PUR" for a consumer electronic product. Note that this information and data is for the given case to be identified.

Using these "reasonably worst case" approximations, LCI results and LCIA results are calculated for the complete system and a contribution analysis performed. Based on that, the most relevant flows and processes of this missing data/information are identified. If feasible and timely, this information can be used during data collection to better steer this step.

##### **Taking a system's perspective**

The procedure described above works directly on the level of the unit process and is straightforward for the flows' chemical elements' mass, energy, and cost and for other potentially relevant emissions. For the final completeness assessment criteria, i.e. for quantifying the completeness of the data in terms of covered overall environmental impact, the environmental impacts related to the consumed goods and services of the unit process need to be included as well. This means that the unit process is first to be completed to a complete system over its life cycle. Using generic or average background data sets to complete this draft inventory, the completeness of the overall impact can be evaluated, and the collection of better unit process data can be focussed on the main contributing goods and services, i.e. their exact specification and amount.

This check is again supported by quantifying the share of data of different quality levels among the aggregated LCIA results, i.e. which share is of "high quality", "basic quality" and which share only of "data estimate" quality, next to the share of lower quality data that is to be cut off (see more below).

It is important to reiterate that completeness / cut-off criteria and precision / uncertainty calculations always relate to the final aggregation level of the developed data set:

In the case the individual unit process data set is the deliverable of the LCI/LCA study, the procedure is as described above. However, any limited completeness in the background LCI data sets is not considered, as those were only added to complete the system and to identify the relevance of the product and waste flows of that unit process.

## Potential sources for data and information to fill gaps

First step to deal with initially missing data is the attempt to measure/obtain the data at the process operator. If this fails, data can be obtained from a third-party LCI data provider.

While data gaps are acceptable for purely methodological studies, a complete lack of funds or time cannot be an excuse for data gaps: If relevant data gaps remain at the end of the LCI/LCA study, it cannot deliver quality results and may fail to answer the initial question.

However, budgets are always limited and data gaps will often occur also in appropriately funded LCI/LCA study. At least the following principle options exist for dealing with missing information:

- calculation from other, known information,
- using information from similar processes or regions with similar process operation (and background processes in case of LCI results) or older data,
- estimate the value based on specific expertise,
- using methodologically not fully but sufficiently consistent data (what mainly refers to LCI data sets for background use), or
- accept and document the gap.

Which is the best solution, depends on the specific case: qualified estimates may be very accurate while using data from not sufficiently similar processes or regions may result in relevant errors. A good technical understanding of the process is indispensable to correctly deal with missing data. Measures taken are to be documented.

## Calculating data values

Often available information can be combined to generate the missing information, e.g. by stoichiometrically calculating CO<sub>2</sub> emissions of an incineration process by multiplying the carbon content of the fuel with the stoichiometrical factor 44/12, assuming a full combustion<sup>140</sup>.

## Completing the inventory via correlations

Another approach is to improve incomplete but measured foreground data (which often has only few emitted substances measured) via correlation with further elementary and waste flows as well as consumables, services etc. from generic data of the same process, thereby completing and improving the inventory.

## Adjusting data from other countries / markets or from similar technologies

Another principle possibility is to adjust existing data that represent a similar situation. However, to do so requires a very good understanding of which differences exist e.g. in the technology mix between two countries, which specific raw material basis is used, which raw gas treatment technologies are applied, etc. (and also which legal emission limits may apply). The number of aspects is very extensive and specific for each case.

As was already highlighted in a frequent error box in chapter 6.8.3, it can be found often in practice that data receive just a basic adjustment (e.g. by replacing electricity background data) and are assumed to sufficiently represent another country. Without working together with technical experts of the respective sector and / or country, and without a systematic and case-wise adjusted approach such an adjustment can be expected to not result in sufficient data quality.

---

<sup>140</sup> I.e. 44 g per mol of CO<sub>2</sub> divided by 12 g per mol of C.

## Expert estimates

For still missing data, a value may be estimated based on expert judgment e.g. using data from a sufficiently similar process or the same process modelled for another country (given the technology, operation conditions, and e.g. abatement technologies are comparable). If a sensitivity analysis based on such estimates shows that the process may be important, the estimated data may have to be replaced by data that are more precise in order to meet the requirements on the precision of the overall results.

Also here the expert should primarily have the necessary technical expertise. The also required LCA expertise can come from the LCA expert that performs the data modelling.

An example: If e.g. particle emissions are only available as "Particles" without particle size information, a worst case assumption would be "PM < 0.2  $\mu\text{m}$ ", a reasonable case assumption would look at the typical particle size class of a similar process and use that one (e.g. "PM 2 to 10  $\mu\text{m}$ ").

If no information on particle emissions is available at all, but expert judgement reveals that the process is known to emit relevant amounts (e.g. as it is an ore roasting or incineration process), it is inserted as PM flow and the appropriate particle size would be determined by looking into processes that generate particles in a comparable way.

## Using methodologically not fully consistent data

As a last resort and upon individual justification methodologically not fully but sufficiently consistent data can be used to fill remaining data gaps.

Data of methodologically different nature and entirely different modelling approaches cannot be used to fill data gaps, as no information can be given on the achieved accuracy, completeness, and precision and as the degree of methodological consistency equally cannot be stated.

## Only including data that improve the overall quality

In order to actually improve the overall data quality, only data or data sets that effectively increase the overall quality of the final inventory of the analysed system shall be used to fill data gaps. That means that the individual data or data set's quality (i.e. combined accuracy, precision, completeness and its methodological appropriateness and consistency) has to be at least equivalent to the "Data estimate" quality level (see annex on data quality indicators and levels).

It is argued to be better to report a gap (while documenting which specific information is available, e.g. the type of flow) instead of using e.g. background LCI data sets to fill the gap while at the same time reducing the overall data quality. The available information should however be kept, while without including them in the final inventory, quantitative impact assessment, etc. The next chapter has more on how to deal with such remaining gaps.

## On worst-case assumptions

Note that reasonable worst-case or conservative assumptions are problematic if the data is foreseen to be used for comparisons: While a rather conservative (i.e. higher) value may be seen as appropriate when providing inventory data of own products, this affects also subsequent uses on other systems and may result in distortions of the results of other systems and related comparisons.

Conservative or reasonable worst-case assumptions are however useful as initial estimate for identifying whether a flow or process is to be inventoried at all. Conservative assumptions can also be used to evaluate the robustness of comparisons, i.e. to evaluate whether the

superiority of an alternative is still valid if conservative or even worst-case assumptions are made for its inventory values.

Any form of conservative or worst-case estimates or processes must however not stay in the final process or system model.

### 7.4.2.11.3 Dealing with remaining unit process data gaps / missing data

#### Overview

After the above steps, some data may still be missing, qualitatively or quantitatively. This chapter deals with the question how to deal with these gaps in reporting.

#### Types of missing data and information

Missing information can be of different type and have different characteristics, and they require different ways to deal with them. There can be missing:

- qualitative information (e.g. specific kind of emission or consumable, such as "metals" emission to air, or "energy" consumed)
- quantitative information (e.g. sufficiently precise amount of a flow, such as "below 0.005 kg", or "between 0.1 and 2.5 kg", "unknown amount")

This can relate to

- product or waste flows (what implies that the life cycle inventory of the provision of the product or treatment of the waste is equally qualitatively or quantitatively not sufficiently known)
- elementary flows (what implies that often the classification, i.e. link to the relevant impact category/ies is/are missing, and in any case the specific characterisation factor(s) cannot be given)

An additional difficulty is that the limited available information could be documented in the inventory of an unit process level, while when calculating LCI results, an appropriate solution is to be found how to combine such partial data gaps (qualitative or quantitative) with available information (e.g. how to sum up an unclear or unknown amount of lead emission to air with the same emission of another process that is known to be e.g. 0.00026 kg. Unknown kg plus 0.00026 kg = ?).

#### Principles to be followed

The principles that are followed here to derive a suitable approach are

- to keep the available information for further uses, including for interpretation of the relevance of gaps and for review
- to support an automated use of the available information, while acknowledging that a use shall also be possible if uncertainty calculation is not performed and without increasing the complexity of the inventory with many specific flows and semi-quantitative information
- to avoid combining highly uncertain information / data with more certain data, i.e. to report a gap instead of decreasing the overall quality of the inventory item

#### How to deal with remaining missing inventory data / information

The following provisions are made:

- Missing qualitative information for a unit process inventory item: The respective flow should be created and used in the regular inventory only if it is a product or waste flow.

Unclear elementary flows (e.g. "Metals to air") shall not be kept in the regular inventory but this information shall be documented in another way. This can be either as clearly marked flows that shall not be combined with the elementary flows of the regular inventory when aggregating the data sets of the analysed system, The flows can be marked e.g. as "missing important" or "missing unimportant", as applicable (see more below), and be excluded from the aggregation. Or they can be documented exclusively in the descriptive information of the data set (e.g. as attached lists).

- Missing quantitative information for a unit process inventory item: The flow should be inventoried. If no quantitative information can be given, this has to be documented by marking the flow as "missing important" to avoid misleading readers, as the true value is not zero. The omission must be explicitly addressed and considered in the interpretation of the results. If a conservative estimate for a missing data fails to show any quantitative importance, a zero value<sup>141</sup> may be entered for this data, but marking it as "missing unimportant". If a mean value or a wide range of values (Min and Max) can be given, this should be entered in the inventory. Uncertainty information such as standard deviation and distribution type should be given if possible and if this information has sufficient precision. For both the above cases, the values shall not be aggregated when calculating LCI results. This can be achieved e.g. by marking these inventory items as "missing important" or "missing unimportant", as applicable (see more below), and excluding such flows from the aggregation.
- Missing qualitative and quantitative information: See preceding two points that are to be combined.
- Missing LCI data for processes / systems in the background system: When aggregating the unit processes of the analysed system to LCI results, product and waste flows for which background data of sufficient quality is not available, these flows shall remain in the aggregated inventory, i.e. making the data set a "partly terminated system". The user of such data shall be explicitly informed in a prominent place that these parts of the system need to be still completed or the gap be considered in the further use and interpretation.

The above referenced classification "Missing important" and "Missing unimportant" relates to the question whether the flow is relevant for the LCI results of the unit process data set in which it occurs, if completed to a system data set. Note that this shall include both the type of flow and its amount; for product and waste flows this includes the respective life cycle inventories of the system that they represent (for product flows) or of their management and treatment (for waste flows). The approximation of the flow's relevance may be supported by uncertainty calculation and quantitative calculation of data accuracy.

#### 7.4.2.11.4 Documentation

It is recommended to document all such combinations, extrapolations, calculations, correlations, expert judgements, approximations and measures to fill data gaps, etc. on individual data values on unit process level to support a review of the data. This can be done directly inside the unit process data set or in accompanying raw data documentation files.

---

<sup>141</sup> LCA software generally does not have empty values or support inventory values such as "<0.5" and the like. Also, such unspecified values cannot be summed up with existing values from other processes when calculating the LCI results. For these reasons the value "0" is to be entered in the inventory. If information of the named type "<0.5" is available, such should be documented as comment for the respective inventory flow or the raw data background documentation.

### Provisions: 7.4.2.11 Interim quality control

These provisions can be applied for the entire system or the single unit process that is analysed / developed.

Many of the following provisions on interim quality control are only recommendations, but the same controls may be part of a subsequent mandatory external review.

#### General approach (7.4.2.11.1)

- I) **SHALL - Validity check:** A validity check of the collected data shall be performed during the process of data collection and unit process development, to confirm that the data is in line with the goal and scope requirements. The following provisions provides related operational recommendations on this requirement:
- II) **MAY - Interim quality control as review along "interpretation" provisions:** For the interim quality control on the unit process level, it is recommended to apply the data quality related technical aspects of the critical review (chapter 11) regarding the scope and methods of review together with the guidance of chapter 9 on interpretation (especially significant issues, sensitivity check, completeness check, and consistency check). These steps can however be done in a less formal way. Among others, the following may be done at this point: [ISO+]
  - II.a) **All relevant flows?:** Does the unit process inventory include all relevant product, waste and elementary flows that would be expected based on e.g. the input of processed materials, of the nature of transformations occurring in the process, and/or based on experience gained with similar processes? Reflect the required technological, geographical and time-related representativeness.
  - II.b) **Flow amounts are proportionate?:** Are the amounts of the individual flows and of the chemical elements, energy and parts in the input and output in expected proportion to each other?
  - II.c) **Support control by impact assessment:** Controls may also be based on impact assessment results for the process as well as for the whole system. They may reveal errors in the inventory results through showing unexpected high or low values of contributing elementary flows. Compare the LCIA results with data of the same or similar processes / systems from other sources to identify possible problems. Make sure the other sources are of high quality and especially high completeness.
  - II.d) **Method consistency?:** On the system level, carefully check that methods have been applied consistently. This especially applies if combining data from different sources.
  - II.e) **Follow up on discrepancies:** Check and explain or correct any observed discrepancies in the inventory data by consulting additional data sources or technical experts for the analysed process.
  - II.f) **Report on findings:** It is recommended providing for the unit process data set an at least brief internal quality control report on the above findings.
  - II.g) **Reflect findings in data set quality indicators:** Make sure that the data set documentation appropriately describes the process and the identified accuracy, precision, and completeness as well as any limitations.

### Provisions: 7.4.2.11 Interim quality control

#### Obtaining better unit process data (7.4.2.11.2)

- III) **SHALL - Dealing with initially missing data:** The potential importance of initially missing data shall be checked in the following way and relevant gaps shall be filled if possible and as detailed below: [ISO!]
- III.a) **SHOULD - Identify relevance of initially missing data:** A reasonable worst case or at least conservative value for the missing data should be used in a first screening to see if they may influence the overall results of the LCI/LCA study. This reasonable worst case or conservative value may be derived by inference from knowledge of similar or related processes or from correlation or calculation from other flows of the process. This includes identifying and inventorying flows that were initially not known to occur in the analysed process but that could not be excluded entirely.
- III.b) **SHOULD - Dealing with relevant, initially missing data:** If this screening shows that the missing data may be of importance, in further iterations of the LCA work it should be attempted to first identify whether the flow is actually occurring in the analysed process and if so to get the yet missing data. As second option sufficiently good estimates should be obtained. As third option, if also that is not possible, the gap should be kept and reported. (Details see separate provisions more below):
- III.c) **SHALL - Filling data gaps with estimates of defined and minimum quality:**
- III.c.i) **SHALL -** For each newly modelled unit process any initially missing data should be documented in a transparent and consistent way. At the end of the iterative steps of improving the data set, the finally missing data and the potential use of data estimates to fill data gaps shall be documented in a transparent and consistent way (see chapter 10 on reporting).
- III.c.ii) **MAY -** For judging the relevance of an initial data gap, it is necessary to approximate the achieved accuracy, completeness and precision of the overall environmental impact on system level. This necessarily needs that the subsequent steps of modelling the life cycle and calculating LCI results and LCIA results need to be done first (see next chapters). It is recommended to do this in parallel to developing the unit process data set. For unit processes this means completing the life cycle model around the unit process with background data. Any limited completeness in the used background data shall be not considered when calculating the achieved degree of completeness for the unit process for the final reporting.
- III.c.iii) **MAY -** For filling data gaps for single flows estimate data (sets) may be considered to be used. Such may be e.g.:
- III.c.iii.1) generic or average data for missing specific data,
- III.c.iii.2) average data of a group of similar products for missing inventory data for other, not yet analysed products of that group,
- III.c.iii.3) correlation with other, more complete and high quality data for



### Provisions: 7.4.2.11 Interim quality control

the same or similar process but from other data sources (e.g. industry average data for improving a producer-specific process),

III.c.iii.4) justified judgements of technical experts / process operators.

III.c.iv) **SHALL** - Data gaps shall generally be filled methodologically consistent data. Gaps of low relevance may also be filled with methodologically not fully but sufficiently consistent data sets while being developed along the guidance of this document and meeting the overall quality requirements as detailed below.

III.c.v) **SHALL** - Only data that increase the overall quality of the final inventory of the analysed system shall be used to fill data gaps. That means that the individual data / data set's overall quality (i.e. combined accuracy, precision, completeness, and methodological appropriateness and consistency) shall be equivalent to at least the "Data estimate" quality level; see annex 12.3.

Note that this shall include both the quality of the used data estimate and of the amount of the flow. That semi-quantitative approximation of the integrated data estimate plus flow amount quality shall be based at least on an individually, briefly justified expert judgement, explicitly considering the named shortcomings; this may be supported by uncertainty calculation and quantitative calculation of data accuracy.

Note that both the approach(es) used to estimate initially missing data and the resulting lack of representativeness, precision and methodological consistency on data set level is later to be clearly documented and explicitly considered when declaring the achieved data set quality.

#### Dealing with remaining unit process data gaps / missing data (7.4.2.11.3)

IV) **SHALL - Document remaining data gaps:** If data estimates cannot be made available that would meet the above requirements, the data gap shall be kept and be documented instead. The following provisions are made: [ISO!]

IV.a) **Missing qualitative information for a unit process inventory item:** The respective flow should be created and used in the regular inventory only if it is a product or waste flow. Little specified elementary flows (e.g. "Metals to air") shall not be kept in the regular inventory but this information shall be documented in another way. This can be either as clearly marked flows that shall not be combined with the elementary flows of the regular inventory when aggregating the data sets of the analysed system, The flows can be marked e.g. as "missing important" or "missing unimportant", as applicable (see more below), and be excluded from the aggregation. Or they can be documented exclusively in the descriptive information of the data set (e.g. as attached lists).

IV.b) **Missing quantitative information for a unit process inventory item:** The flow should be inventoried. If no quantitative information can be given, this has to be documented by marking the flow as "missing important" to avoid misleading readers, as the true value is not zero. The omission must be explicitly addressed and considered in the interpretation of the results. If a conservative estimate for a missing data fails to show any quantitative importance, a zero value may be entered for this data, but marking it as "missing unimportant". If a mean value or a

### Provisions: 7.4.2.11 Interim quality control

wide range of values (Min and Max) can be given, this should be entered in the inventory. Uncertainty information such as standard deviation and distribution type should be given if possible and if this information has sufficient precision. For both the above cases, the values shall not be aggregated when calculating LCI results. This can be achieved e.g. by marking these inventory items as "missing important" or "missing unimportant", as applicable (see more below), and excluding such flows from the aggregation<sup>142</sup>. Or they can be documented exclusively in the descriptive information of the data set (e.g. as attached lists).

- IV.c) **Missing qualitative and quantitative information:** See preceding two points that are to be combined.
- IV.d) **Missing LCI data for processes / systems in the background system:** When aggregating the unit processes of the analysed system to LCI results, product and waste flows for which background data of sufficient quality is not available, these flows shall remain in the aggregated inventory, i.e. making the data set a "partly terminated system". The user of such data shall be explicitly informed in a prominent place that these parts of the system need to be still completed or the gap be considered in the further use and interpretation.

Note that any kind of worst case or conservative data and assumptions shall not be kept in the inventory of LCI data that are foreseen to be applicable for comparisons, unless the representing process operators or system producers themselves wish so (e.g. to align LCI data reporting with other values reported on e.g. site or company level). Note that reasonably worst-case data may however be used for scenarios and for checking the robustness of comparisons when doing the sensitivity analysis.

Note the specific requirements for product comparisons such as on e.g. the consistency of methods, data quality, and assumptions across the compared alternatives (for details see chapter 6.10).

## 7.4.3 Overarching method provisions for specific elementary flow types

(Refers to aspects of ISO 14044:2006 chapters 4.2.3.5 and 4.3.2.2)

### 7.4.3.1 Introduction and overview

(Refers to aspects of ISO 14044:2006 chapters 4.2.3.5 and 4.3.2.2)

A couple of issues are of overarching relevance and require the same, compatible solutions in support of integration of data compiled along supply-chains and by different developers. They also serve to improve reporting and easing review of the LCI/LCA study.

They equally are of interest for defining the reference elementary flows of the ILCD system and Data Network, together with the provisions on "Nomenclature and other conventions" that are given in the respective separate guidance. At the same time they provide guidance for further, consistent elementary flows to be created expanding that initial list.

<sup>142</sup> LCA software generally does not have empty values or text entries for the amount of an inventory flow, as it must be able to sum up the entries. If hence a value zero is (automatically) assigned, the classification "missing important" ensures that this gap is clearly documented and that flow can be treated differently.

Furthermore, some issues are strongly interlinked with LCIA method development and characterisation factor provision (e.g. sum indicators and elementary flow groups, see next subchapter).

Other overarching provisions relate to product and waste flows. These were already mentioned earlier such as the inventorying of their energy content and chemical element composition in support of interim quality control, review and improving data quality. Others relate to specific process types and are addressed in the sub-sequent chapter.

A number of considerations are being made to derive the most appropriate solutions to these overarching methodological issues, especially for elementary flows:

- Distorted impact assessment and “hidden” highly impacting flows in aggregated inventory values must be avoided.
- Incomplete impact assessment due to “forgotten” newly created flows is to be avoided.
- The number of flows in the inventory should be kept as low as reasonably possible without relevantly affecting impact assessment, i.e. the differentiation of flow data sets should be not more fine than supported by state-of-the-art LCIA methods and not coarser than required to capture differences in the LCIA results.
- The normal LCA practitioner cannot generally be expected to calculate and assign specific or composed impact factors.
- Limitations in data availability (or the possibility to derive data via calculations, or sum indicator break-down lists derived from similar processes, etc.) and in budgets are to be accommodated as far as possible, without affecting the quality or robustness of the analysis.
- A broad compatibility of elementary flows, independently of applied LCI modelling frameworks is to be achieved.

Common for both attributional and consequential modelling are a couple of overarching methodological issues that relate to inventory flows and inventory modelling. Among these are question on inventorying sum indicators and resource flows, how to inventory future long-term emissions, how to model CO<sub>2</sub> uptake, storage and release, and the like. These are to be dealt with in the same way, to ensure that LCI data from different data developers can usefully be combined with each other when modelling systems. Equally these serve to ensure that LCIA factors are readily available and elementary flows are not “forgotten”, as a LCIA factor does not exist and practitioners cannot regularly derive specific factors.

### 7.4.3.2 Emission of measurement indicators and elementary flow groups

(Refers to aspects of ISO 14044:2006 chapter 4.2.3.5)

#### Introduction and overview

Elementary flows should wherever possible be inventoried as individual substances / interventions rather than as measured indicators such as “AOX” (Adsorbable organic halogenated compounds) or “COD” (Chemical Oxygen Demand) emissions or elementary flow groups like “heavy metals” or “hydrocarbons” emissions. Such measured and grouped elementary flows are in general not suitable for a subsequent impact assessment and can cause large bias in the results, either exaggerating or underestimating the real impact potential.

## Practical approach

Measurement indicators (i.e. measured emission characteristic such as “VOC” (Volatile Organic Compounds) and “COD”) and to a lower degree also certain flow groups (i.e. groups of elementary flows such as “Alcohols”) are common in industry practice of measuring emission data e.g. due to legal compliance requirements, measurement techniques (e.g. flame ionization detectors) or in order to limit highly costly measurements of many single substances. Directly measured data on the level of single substance elementary flows are hence often not available. This is (and will stay) the LCI reality the LCA practitioner has to face.

It is hence acknowledged that measurements of individual species are often not possible or affordable, but technology experts with knowledge about a specific process or process type (e.g. “solid fuel incineration”) may be able to quantitatively differentiate the emissions on a more detailed level. Such process-type-specific “emission fingerprints” (e.g. for heavy metals composition of the off-gas from a steel blast furnace refinery or the VOC composition from diesel motor off-gases) can be taken case-by-case from industry or research studies. Default break-down lists of the most commonly measured indicators for a range of relevant technology processes could be developed in subsequent work under the ILCD System. For some processes with very heterogenic emission profiles and for some sum indicators and flow groups a simple splitting up into its components is not directly possible but needs a further differentiation, by also considering the process’ operation condition, i.e. having more than one profile for such processes. However, a number of LCIA-wise rather homogeneous sum indicators and flow groups can be used, until default break down lists are generally available (the “Provisions” give the detailed provisions).

The situation is more complicated, if some of the constituents are measured separately and the remainder amount is inventoried (e.g. the amount of Carbon monoxide emissions would be known and its mass subtracted from the amount of “Diesel engine off-gas” in the inventory). This distorts the composition of the sum parameter and typically renders the LCIA impact factor distorted for the remaining amount of the “Diesel engine off-gas” (i.e. without the CO). A partial split of measured indicators should be avoided, as the remainder will typically lead to a distorted impact assessment. At the same time is it not permissible to hide highly impacting (e.g. toxic) substances in common sum indicators (e.g. may PAHs (Polycyclic aromatic hydrocarbons) not be hidden in COD, etc.). These particularly impacting substances should be singled out, if they were measured separately or their existence and amount can be derived in other ways. Partial splitting with singling out flows with a lower than average impact shall not be done in any case.

As one exception for sub-stance groups, for Dioxins it is very wide praxis to inventory them as 2,3,7,8-TCDD equivalents (2,3,7,8-Tetrachlorodibenzodioxin human toxicity equivalents). This is argued to be acceptable as the equivalent number already relates to the relevant impact of interest, i.e. eco-toxicity and human toxicity. However, if available individually, the single species shall be inventoried.

The resulting detailed lists of permitted measurement indicators and substance flow groups is given in the "Provisions".

### **Provisions: 7.4.3.3 Emission of measurement indicators and elementary flow groups**

- 1) **SHALL - Measurement indicator and substance group elementary flows:** These shall be inventoried as follows: [ISO!]

- I.a) **Avoid indicators and flow groups; with permissible exceptions:** Measurement indicator and substance group elementary flows shall be avoided in the inventory by splitting them up to single substances. Exclusively the following exceptions are permissible, while they should be split as well: COD<sup>143</sup>, BOD, AOX, VOC, NMVOC, PAHs, PCBs, TOC, DOC, Nitrogen in Nitrogen compounds (excluding N<sub>2</sub>, N<sub>2</sub>O), Phosphorus in Phosphorus compounds, Dioxins (measured as 2,3,7,8-TCDD human toxicity equivalents).
- I.b) **Restrictions on partial splitting:** A partial splitting up of measurement indicators and substance group flows should be avoided. This is except for singling out exclusively elementary flows that have higher impacts than the average of the indicator / group and that should be singled out. Partial splits with singling out elementary flows with less than average impacts shall not be done. If singling out single substance elementary flows from the above indicators / flow groups, only the remainder amount of the indicator or flow group shall be inventoried.
- I.c) **No double-counting:** Double-counting across the above indicators / flow groups and with the contained individual substances shall be avoided (i.e. correct is to inventory either "BOD" or "COD"; either "VOC" or "NMVOC" plus "Methane"; either "Nitrate" plus "Ammonia" plus ... or "Nitrogen in Nitrogen compounds"; etc.).
- I.d) **Document composition:** If measured composition information of a split measurement indicator or substance flow group is not available, an assumed composition can be used. Approach and assumptions shall be documented.
- Note that the composition of a measurement indicator or substance flow group can often be derived without direct measurement from process know-how (e.g. processed materials, educts, etc.) or those of sufficiently similar process can be considered<sup>144</sup>.
- I.e) **Do not combine measured flows:** Individually measured substances shall not be integrated/combined into measurement indicators and elementary flow groups but be inventoried individually.
- II) **MAY - Use "Reminder flow" to keep originally measured indicator or flow group:** It is recommended to document the originally measured amount of the split indicator or flow group in the inventory as a "Reminder flow". "Reminder flows" shall later be excluded from the impact assessment, i.e. have no characterisation factors and be clearly identified as "Reminder flows" (on naming see chapter 7.4.3.8). [ISO+]

Note that if the above provisions cannot be fully met, this shall be explicitly considered when reporting achieved data quality and when interpreting the results of LCA studies. Note that LCI data sets' inventories that do not meet the above requirements are not compliant with the ILCD nomenclature.

<sup>143</sup> COD = Chemical oxygen demand, BOD = Biological oxygen demand, AOX = Adsorbable organic halogenated compounds, VOC = Volatile organic compounds, NMVOC = Non-methane volatile organic compounds, PAH = Polycyclic aromatic hydrocarbons, PCB = Polychlorinated biphenyls, TOC = Total organic carbon, DOC = Dissolved organic carbon.

<sup>144</sup> Default-composition tables for different process-types and industries might be developed in PCR-type or sector-specific guidance documents.

### 7.4.3.3 Emission of ionic compounds

(Refers to aspects of ISO 14044:2006 chapter 4.2.3.5)

#### Introduction and overview

For a number of compounds methodological questions arise how to inventory them, e.g. is the ionic but environmentally very stable substance CdS to be inventoried as the two ions  $\text{Cd}^{2+}$  and  $\text{S}^{2-}$  or as the compound CdS? For the impact assessment this is crucial, as the fate strongly depends on water solubility. For particle emissions only those that do not dissolve in the lungs act carcinogenic. To limit the number of elementary flows and to avoid "forgetting" flows that have no impact factors assigned, it is desirable to limit the number of single elementary flows by inventorying the ions separately.

Along the initially named considerations, the following solution is derived:

Easily water soluble ionic compounds (e.g. salts such as Ammonium nitrate, Cadmium chloride, etc.) are to be inventoried as the ions of which they exist: These compounds, when released to the environment (with some exceptions however) behave largely as if dealing with the ions separately. Looking at a single particle and its solubility in one droplet of water of 1mm diameter and hence about 0.0005 ml (formed as rain or in the lung tissue), the limit is set roughly where at 20°C less than half of a particle of 2 µm diameter dissolves in that amount of water. This depends also on the density of the material, but for orientation assuming the density to be 2 kg/litre resulting in a particle mass of about  $8 \cdot 10^{-12}$  g, the border is at  $0.5 \cdot 8 \cdot 10^{-12}$  g / 0.0005 ml =  $8 \cdot 10^{-9}$  g/ml (or  $8 \cdot 10^{-6}$  g/litre, i.e. about 10 µg/litre). As convention the limit is hence set at a solubility in water at 20°C of below 10 µg/litre<sup>145,146</sup>.

Less good water soluble compounds are to be inventoried as compound.

Note that this provision - other than the similar provision on particles does not apply for water-soluble, dissociating organic compounds.

#### Provisions: 7.4.3.3 Emission of ionic compounds

- 1) **SHALL - Inventory easily water soluble salts as ions:** For data sets as deliverables, emissions to air, water, or soil of easily water-soluble ionic compounds (salts) shall be inventoried as separate ions, unless the selected LCIA methods would require otherwise. As convention, the limit is set at a solubility in water at 20°C of 10 µg/litre, above which the ions shall be inventoried separately, below which the compound shall be inventoried. This applies unless the selected LCIA method requires otherwise. [ISO!]

Note that if the above provisions cannot be fully met, this shall be explicitly considered when reporting achieved data quality and when interpreting the results of LCA studies. Note that LCI data sets' inventories that do not meet the above requirements are not compliant with the ILCD nomenclature.

### 7.4.3.4 Emission of particles to air

(Refers to aspects of ISO 14044:2006 chapter 4.2.3.5)

#### Overview

Three issues play a role for particulate mater:

<sup>145</sup> Some examples:  $\text{CaCO}_3 = 600$  µg/l,  $\text{Cu(OH)}_2 = 17$  µg/l,  $\text{CdS} = 0.0001$  µg/l.

<sup>146</sup> For orientation: for a substance of 100g/mol this is hence 0.001 mol/litre.

Particle size classes, water solubility, and additivity of impacts.

### Particle size classes

Firstly, and given the different impact, particulate matter should be split up into different size classes with different toxicity implications (as the size determines the access to the lungs and uptake into the lung tissue).

### Water solubility

Secondly for particulates it is to be considered that only particulate matter emissions to air that are insoluble in water are relevant for human toxicity. The easily water-soluble ones such as e.g. Ammonium nitrate when inhaled will immediately solve in the tissue water and pose no carcinogenic effect due to their particle character. Hence, not to overestimate the impact, the composition of the measured PM should be identified or derived from the source-process to determine whether/how much of it is water-soluble.

Note that this applies not only to inorganic salts but also to e.g. organic substances.

The third issue also relates to other types of emissions:

### Emission of substances with several additive / serial action schemes

Elementary flows with additive / serial action schemes (e.g. NO<sub>x</sub> as contributing to both Photochemical ozone creation (summer smog) and Eutrophication) need to carry more than one characterisation factor.

Complex elementary flows may need a special treatment in inventorying. E.g. an emission to air of 0.0001 kg Particles (<2.5 µm) that contains 50 % Chromium VI implies an additive cancer potential from both being a particle and being (to 50 %) Chromium VI.

To avoid that a huge number of "Particle XY" elementary flows with different composition needs to be inventoried (including the problem for LCA practitioners to correctly assigning the impact factors), a splitting up into the single components (e.g. in the given example into 0.0001 kg "Particles <2.5 µm" plus 0.00005 kg "Chromium VI") is recommended. In this case (and analogously if both the amount of particles and the amount of chromium are separately measured but in the same off-gas stream), both amounts are inventoried as separate elementary flows. Note that this results in a (in absolute terms however very small) double counting of the mass. The impact effect however is more appropriately addressed. As an exact mass-balance of LCI results is never given in practice (as e.g. incineration air is left out, certain water losses are not inventoried etc.) this minor double counting of the masses (while correctly addressing the effect of the inventory) is acceptable<sup>147</sup>.

Note: In the cases of interest in a more detailed impact modelling and taking into account more details such as speciation, in such specific application cases also more specific elementary flows can be created, of course, while for background databases this should be avoided, as to ensure a consistent databases and to have appropriate LCIA factors available and fully linked to the inventory.

---

<sup>147</sup> Discussion of other options: Other solutions could be, to inventory only the most important aspect as a flow (in the above example e.g. as particles <2.5 µm without Chromium) or to enter only the most important impact factor into the combined flow. This however creates problems, where the substance contributes to different impact categories (e.g. "NO<sub>2</sub> to air" to Human Toxicity and Eutrophication), since it is not possible to determine independently, which of the different impacts is quantitatively more important. The possibility to apply reduced characterisation factors for both effects - which may be developed in the future by LCIA - is kept. This is however not expected to solve this issue, as it causes a number of other problems in LCI practice. Among others a steadily growing set of elementary flows of slightly different composition that would require the final users / LCA practitioners to correctly calculate and assign the impact factors to these new flows.

### Provisions: 7.4.3.4 Emission of particles to air

- I) **SHALL - Inventory only poorly water soluble compounds as particles:** Particulate matter (PM) emissions to air shall include only poorly water-soluble compounds below a solubility in water at 20°C of 10 ug/litre, as far as feasible. Expert judgement may be needed to identify the composition of the particles. [ISO!]
- II) **SHOULD - Differentiate particle size classes:** Particles should be reported split up by particle size class <0.2 µm, 0.2-2.5 µm, 2.5-10 µm, >10 µm if the information is available. <10 µm may be used alternatively if a more differentiated information below 10 µm is not available. This applies unless the selected LCIA method requires otherwise. [ISO!]
- III) **SHALL - Inventory particles additionally as the substances they are composed of:** Particles shall be inventoried as both PM and additionally as elementary flows of their environmentally relevant components (e.g. metals contributing to cancer effects), i.e. double counting their mass in the inventory, as far as possible. This applies analogously to other emissions with additive action schemes. [ISO!]

Note that if the above provisions cannot be fully met, this shall be explicitly considered when reporting achieved data quality and when interpreting the results of LCA studies. Note that LCI data sets' inventories that do not meet the above requirements are not compliant with the ILCD nomenclature.

### 7.4.3.5 Emission of substances of complementary, alternative action schemes

(Refers to aspects of ISO 14044:2006 chapter 4.2.3.5)

For the emission of substances of complementary, alternative action schemes, the fate is fully modelled in the LCIA method and the impact factors consider this fact. An example are NO<sub>x</sub> emissions to air that either have a Human toxicity effect (inorganic respiratory effect) or an Eutrophication effect on land and water bodies).

### 7.4.3.6 Resource elementary flows

(Refers to aspects of ISO 14044:2006 chapter 4.2.3.5)

#### 7.4.3.6.1 Energy resources

(Refers to aspects of ISO 14044:2006 chapter 4.2.3.5)

Taking into account the initially made considerations, the following can be concluded for energetic resources: To evaluate the resource depletion of energetic resources, with currently used and practice-tested impact models do not require differentiating them by their specific energy-content/mass ratio or by the country or origin. This allows to keep the number of non-renewable energy resource elementary flows low, i.e. instead of hundreds of elementary flows of the type "Crude oil Norway", "Crude oil Saudi Arabia", or "Brent Spar", "Tia Juana Light" etc., or "Crude oil 42.6 MJ/kg", "Crude oil 42.3 MJ/kg", etc. only 1 (most energy resources) to 3 (crude oils) elementary flows are required (see below).

To support established practice in resource-depletion impact assessment of energetic resource elementary flows, exclusively a differentiation by type of deposit/source is required, i.e. primary, secondary, tertiary crude oil and open pit or underground mining of hard coal. Other fossil fuel resource elementary flows (natural gas, oil shale, tar sand, lignite, peat) do currently not need a differentiation.



For renewable energy forms, the usable amount of energy that is extracted from nature is to be inventoried. E.g. for solar electricity and heat this relates to the amount of electricity and/or heat captured by the solar cells (i.e. not the total solar energy, but what is delivered directly by the cells as electricity and/or usable heat). For biomass from nature this is the amount physically embodied, measured as Lower calorific value, however of the water-free substance (i.e. measured as if the e.g. wood would be oven-dry). Note that biomass from fields and managed forests is no elementary flow. In that case, the named energy resources shall be inventoried directly as the respective elementary flows, e.g. "Solar energy" as "Renewable energy resources from air", expressed as Lower calorific value and measured in the reference unit MJ.

As to the reference flow property and the reference unit of energetic resources see the respective chapter in the separate document "Nomenclature and other conventions".

### 7.4.3.6.2 Ores for winning metals or other elemental constituents

(Refers to aspects of ISO 14044:2006 chapter 4.2.3.5)

Taking into account the initially made considerations, the following can be concluded for non-energetic resources: To evaluate the resource depletion of most non-energetic resources with currently used and practice-tested LCIA methods, it is not required to differentiate them by their specific element-content/mass ratio or by the country or origin.

This allows lowering the number of elementary flows in the inventory, following a similar approach as for the non-renewable energetic resource elementary flows (see also previous point). The inventorying of (metal) ore elementary flows shall hence be based on a differentiation of ore bodies or minerals into the single elements' elementary flows (e.g. 0.012 kg "Lead" and 0.023 kg "Zinc" elementary flows are inventoried, when e.g. 1 kg Lead-zinc ore (1.2 % Pb, 2.3 % Zn) is extracted. 0.78 kg "Anhydrite" is inventoried, when e.g. an anhydrite-containing body of 1 kg Anhydrite-containing rock (78 % anhydrite) is extracted.) This at the same time allows to overcome the problematic current situation of having a huge number of "impact-free"/forgotten specific ores and minerals in the inventory for which by-default no impact factors are provided.

For functional/material resources it is however necessary to capture their specificity (e.g. "Granite").

To complete the mass flow of the resource, the non-resource part of the ore is to be inventoried as "inert rock" "Resources from ground" (or water, as applicable)<sup>148</sup>.

### 7.4.3.6.3 Land use

(Refers to aspects of ISO 14044:2006 chapter 4.2.3.5)

Direct land use and land transformation shall be inventoried along the needs of the applied LCIA method (if included in the impact assessment). Specific guidance is not provided at this point but might be given in a supplement or revised version.

For CO<sub>2</sub> release caused by land use and land transformation, the use of the most recent IPCC CO<sub>2</sub> emission factors shall be used, unless more accurate, specific data is available. Detailed provisions and table with the current IPCC factors: see chapter 7.4.4.1 and annex 13.

<sup>148</sup> In practice, the inventory of a lead-zinc ore mining process would have in the input-side the above named e.g. "Lead", "Zinc", and "Inert rock" elementary flows, while in the output side the product flow (!) "Lead-zinc ore; 1.2% Pb, 2.3% Zn". (After processing the "tailings" would be a waste that is modelled to the leached emissions.) This has the effect that when calculating LCI results, only the relevant elementary resource flows "Lead" and "Zinc" remain in the inventory, resulting in the desired reduction of the number of elementary flows in the inventory.

Other emissions in result of land transformation (e.g.  $\text{NO}_3^-$  losses to water, emissions from biomass burning, soil erosion etc.) should be measured or modelled for the given case or using authoritative sources.

See chapter 7.4.4.1 also for related issues when modelling agricultural systems.

Indirect land use is an issue under consequential modelling that applies to all kinds of land uses and is hence addressed in chapter 7.2.4.4.

#### **7.4.3.6.4 Fossil and biological $\text{CO}_2$ uptake and release of $\text{CO}_2$ and $\text{CH}_4$**

(Refers to aspects of ISO 14044:2006 chapter 4.2.3.5)

For better methodological clarity and flexibility as well as easier communication, the release of carbon dioxide ( $\text{CO}_2$ ) and Methane ( $\text{CH}_4$ ) is recommended to be additionally differentiated between fossil and biological sources.

Land use change-related  $\text{CO}_2$  emissions from soil, peat etc. in all cases and from biomass and litter of virgin forests shall be inventoried as "Carbon dioxide (fossil)". Emissions from biomass and litter of secondary forests shall be inventoried as "Carbon dioxide (biogenic)".

See also chapter 7.4.3.7.3 on uptake of  $\text{CO}_2$  by plants and release at the end-of-life ("carbon storage").

#### **7.4.3.6.5 Water use**

(Refers to aspects of ISO 14044:2006 chapter 4.2.3.5)

Taking into account the indicator "water use" is still complex since water can come from various sources some of which are renewable (e.g. seawater), others not (e.g. fossil / deep groundwater). Also the release of used water to the environment can have very different forms and ways, some of which only distribute the water from one place to another (e.g. irrigation water), some changing its state (e.g. river water to steam for cooling), and some mainly its quality.

It is recommended to differentiate at least the following on the input side:

- surface freshwater,
- renewable groundwater,
- fossil / deep groundwater,
- sea water.

On the output side it is recommended to at least differentiate:

- Emission in liquid form (e.g. infiltration to soil from irrigation systems, emission of treated wastewater to rivers), and
- emission in form of steam (e.g. cooling water loss as steam from e.g. cooling towers, loss from irrigation systems by evaporation and evapotranspiration).

Emissions in form of steam are lost for other uses. They also change the hydrological and microclimatological situation, hence would require a specific impact assessment.

No specific recommendation is made for water use in hydropower stations. The gained renewable energy shall be inventoried separately and the effect of land use, changed hydrology and ecosystem-connectivity in case of dam systems is addressed with other instruments.

Changes in the quality of the used water shall be inventoried via separate elementary flows, i.e. as emissions of substances or of heat to water.

Important is to clearly differentiate between internally recycled water (e.g. cooling water) and the actual net consumption of water in form of extracting it from the environment.

### Provisions: 7.4.3.6 Resource elementary flows

- l) **SHALL - Provisions for inventorying resource elementary flows:** Resource elementary flows shall be inventoried as follows, with exceptions only if necessary to meet the need of the applied LCIA method: [ISO!]
- l.a) **Energy resources (7.4.3.6.1):**
- l.a.i) **Non-renewable:** These shall be inventoried as type of energy resource and in few cases (only primary, secondary, tertiary crude oil and open pit or, underground mining of hard coal) these should be differentiated exclusively by resource extraction type, if this information is available (e.g. "Crude oil, secondary extraction" but not "Crude, Tia Juana Light"; "Hard coal, underground" but not "Hard coal, Western Germany; 39.4 MJ/kg"). The energy/mass relationship shall be provided for all energy resource flows except for nuclear ores. The energy content shall be expressed in the Lower calorific value of the water-free resource, measured in the reference unit MJ. See also separate document "Nomenclature and other conventions".
- Note that peat, biomass of primary forests, and some other biogenic energy resources are "non-renewable".
- l.a.ii) **Renewable:** Renewable energy resources shall be inventoried as the amount of usable energy extracted from nature. E.g. for solar electricity and heat this relates to the amount of electricity and/or heat captured by the solar cells (i.e. not the total solar energy, but what is delivered directly by the cells as electricity and/or usable heat). For biomass from nature this is the amount physically embodied, measured as Lower calorific value, however of the water-free substance (i.e. measured as if the e.g. wood would be oven-dry). Note that biomass from fields and managed forests is no elementary flow. In that case, the named energy resources shall be inventoried directly as the respective elementary flows, e.g. "Solar energy" as "Renewable energy resources from air", expressed as Lower calorific value and measured in the reference unit MJ.
- l.b) **Avoid geographical differentiation:** Resources shall not be inventoried geographically differentiated (i.e. "Lignite" but not "Lignite, Eastern Germany"). This applies unless the selected LCIA method requires otherwise. (7.4.3.6.1)
- l.c) **Chemical element resources:** Resources for production of metals or other chemical elements should be inventoried as chemical element (e.g. "Iron - Resources from ground" elementary flow). (7.4.3.6.2)
- l.d) **Functional/material resources:** These shall be inventoried as target material resource (e.g. "Schist", "Lime stone", "Anhydrite"). Few exceptions exist where the mineral itself is in industry understood to be the target good; these are reflected in the ILCD reference elementary flows (e.g. "Rock salt", etc.). Other exceptions and exclusively for resources not included in the ILCD reference elementary flows shall be justified by following analogous logic. (7.4.3.6.2)
- l.e) **Flows for completing mass balance:** For completion of the mass balance, a

### Provisions: 7.4.3.6 Resource elementary flows

complementary amount of "Inert rock", "Water", or "Air" (or other, as applicable) shall be inventoried for extracted resources (e.g. 0.96 kg "Inert rock" in case of mining 1 kg copper ore with 4 % copper content). (7.4.3.6.2)

- I.f) **No minerals or ore bodies:** Inventorying of other minerals (unless these are functional / material resources such as "Granite") or of specific ore bodies shall not be done (i.e. "Copper", but not "Malachite" and not "Sulphidic copper-silver ore (3.5 % Cu; 0.20 % Ag)"). (7.4.3.6.2)

Note that when applying the above rules double counting shall be avoided. Newly created elementary flows shall be checked whether they require carrying a characterisation factor for the applied LCIA method.

- II) **SHALL - Land use and transformation:** Direct land use and land transformation shall be inventoried along the needs of the applied LCIA method (if included in the impact assessment)<sup>149</sup>. (7.4.3.6.3)
- III) **SHALL - Emissions from land use and transformation:** If land use and/or land transformation are modelled, carbon dioxide and other emissions and related effects should be modelled as follows: [ISO!]
- III.a) **Soil organic carbon changes from land use and transformation:** For CO<sub>2</sub> release from or binding in soil organic carbon (SOC) caused by land use and land transformation, the use of the most recent IPCC CO<sub>2</sub> emission factors shall be used, unless more accurate, specific data is available. Detailed provisions and table with the IPCC factors: see chapter 7.4.4.1 and annex 13. (7.4.3.6.3)
- III.b) **Land use and transformation related CO<sub>2</sub> emissions from biomass and litter:** For virgin forests and for soil, peat, etc. of all land uses shall be inventoried as "Carbon dioxide (fossil)". Emissions from biomass and litter of secondary forests shall be inventoried as "Carbon dioxide (biogenic)". This applies unless the selected LCIA method requires otherwise. (7.4.3.6.4)
- III.c) **Nutrient losses:** Emissions of nutrients shall be modelled explicitly as part of the land management process. Detailed provisions see chapter 7.4.4.1.
- III.d) **Other emissions:** Other emissions in result of land transformation (e.g. emissions from biomass burning, soil erosion etc.) should be measured or modelled for the given case or using authoritative sources. Detailed provisions see chapter 7.4.4.1. (7.4.3.6.3)
- IV) **MAY - Water use:** It is recommended to differentiate at least: [ISO+]
- IV.a) on the input side: surface freshwater, renewable groundwater, fossil / deep ground water, sea water
- IV.b) on the output side: Emission/discharge of water in liquid form emission in form of steam

<sup>149</sup> While this document has been finalised no established and globally applicable practice was available, but several approaches with either only regional applicability or lack of practice experience. These work with fundamentally different inventorying approaches. Any specific recommendation or requirement on inventorying land use and conversion would be implemented and published via revised ILCD reference elementary flows and recommended LCIA methods, and/or a revision of this document.

### Provisions: 7.4.3.6 Resource elementary flows

IV.c) Other water quality changes, especially by chemical substances shall be inventoried as separate elementary flows.

Note that if the above provisions cannot be fully met, this shall be explicitly considered when reporting achieved data quality and when interpreting the results of LCA studies. Note that LCI data sets' inventories that do not meet the above requirements are not compliant with the ILCD nomenclature.

## 7.4.3.7 Future processes and elementary flows

(Refers to aspects of ISO 14044:2006 chapters 4.2.3.6.2 and 4.3.2.1)

### 7.4.3.7.1 Introduction and overview

(Refers to aspects of ISO 14044:2006 chapters 4.2.3.6.2 and 4.3.2.1)

The issue of future interventions (e.g. during the use-stage of long-living goods and their end-of-life-treatment, as well as delayed emissions from landfills) are addressed jointly with the issue of mid- and long-term removal of carbon dioxide from the atmosphere via storage in long-living bio-based goods as well as with the permanent removal in CO<sub>2</sub> storages e.g. underground.

The provisions on time-representativeness of processes that are operated in the future (e.g. recycling of long-living products) were already made in scope chapter 6.8.4. This present chapter focuses on complementary aspects of emissions that occur in the future.

### 7.4.3.7.2 Differentiating the inventory of interventions in the more remote future (long-term emissions beyond 100 years)

(Refers to aspects of ISO 14044:2006 chapters 4.2.3.5, 4.2.3.6.2 and 4.3.2.1)

#### General

Impacts from processes that run in the future but that are not (necessarily) man-managed but determined today (especially long-term emissions from landfills by leaching and landfill gas) need a convention to provide unambiguous decision support: These are to be modelled by separately inventorying emissions that occur within the next 100 years from the time of the LCI/LCA study (e.g. as "Emissions to water") and those that occur beyond that time frame over an indefinite time (e.g. as "Emissions to water, unspecified (long-term)").

For the long-term emissions it is hence implicitly assumed that no measures are taken by mankind to sanitize/encapsulate the landfill permanently. Note that the operation of the landfill (including e.g. post closure leachate treatment) will necessarily be modelled as implemented / operated today.

#### LCIA of long-term emissions

The emissions within the first 100 years are subject to the same LCIA impact assessment as are all other interventions from the system. The emissions beyond 100 years are not included into the general LCIA results calculation and aggregation, but are to be calculated, presented and discussed as separate LCIA results. This approach is evolving to be widely used. It is important to note that this separate calculation does not indicate per se a lower relevance of long-term emissions; LCA is not including the discounting of future impacts unless this would be part of an explicit weighting.

The logic for the separation of short-term and long-term emissions is that both have often fundamentally different uncertainty: emissions today can be measured, emissions from landfills in 100 years can only be roughly forecasted. At the same time, will the inventory of

landfills - if the emissions are modelled for e.g. 100,000 years - easily dominate the entire LCA results. This is important to know, but needs a separate interpretation. At the same time does this issue illustrate one weakness of LCA: LCIA methods usually do not account for thresholds, but aggregate all emissions over time. Hence even if the concentrations in the waste deposit leachate after 1,000 years might be below any eco-toxic effect, the total amount of these emissions over tenths of thousands of years will be summed up and be considered the same way as the same amount emitted at much higher concentrations over a few years.

It could be argued that as/if landfills are environmentally relevant long-term emitters, mankind will eventually (potentially well before 100 years have gone by) dig them out to sanitize them and/or gaining back e.g. copper and other secondary resources from them.

In summary: emissions within the next 100 years and beyond need a separate impact assessment and appropriate interpretation in view of their different certainty.

#### **7.4.3.7.3 Temporary carbon storage, delayed greenhouse gas emissions, delayed credits for solving multifunctionality**

(Refers to aspects of ISO 14044:2006 chapters 4.2.3.5, 4.2.3.6.2 and 4.3.2.1)

##### **Inventoried and impact assessment of biogenic and fossil CO<sub>2</sub> and CH<sub>4</sub>**

Uptake of “Carbon dioxide” by plants shall be inventoried under “Resources from air”.

Both the uptake of CO<sub>2</sub> from the atmosphere and the release of both fossil and biogenic CO<sub>2</sub> are assigned characterisation factors for the impact assessment. The lack of knowledge whether a carbon dioxide or methane emission is biogenic or fossil (i.e. inventoried as "unspecified") therefore does not render the results erroneous.

##### **The link between temporary CO<sub>2</sub> removal, delayed emissions and the "Global Warming potential 100 years"**

The temporary removal of carbon dioxide from the atmosphere by incorporation into long-living bio-based products, into bio-based material remains in landfills, or in CO<sub>2</sub>-underground-storages is accounted for in the inventory. It is however not considered per default in the overall LCIA results calculation, as LCA per se is not discounting emissions over time<sup>150</sup>; this is unless the goal of the study would directly require that.

The inventorying is done as follows: the duration for which LCIA impacts of released emissions is calculated, is typically explicitly or implicitly indefinite. Exclusively in case of the Global Warming Potential (GWP) the much shorter perspective “GWP 100 years” is widely used (details and recommendations are provided in the separate LCIA guidance documents of the ILCD Handbook). The related characterisation factors used are typically those provided as part of the Intergovernmental Panel on Climate Change (IPCC) reports. Climate change is hence implicitly considered to be a problem of the next 100 years (3 to 4 generations). The long-term removal of CO<sub>2</sub> from the atmosphere and storage in long-living goods is hence politically promoted (see also further notes and aspects in footnote 152).

The difficulty is that the GWP 100 relates to the effect after the emission has taken place i.e. it counts the climate change impact of emissions that occur nowadays exert within the next 100 years. However, these emissions may also occur in the future (in e.g. 80 years when a now newly built house is broken down). Assigning a full GWP 100 factor to these emissions that happen in 80 years would contradict the logic of the GWP 100 detailed above, as in that case their climate change effect for 180 years from now would be accounted for.

---

<sup>150</sup> But see chapter 7.4.3.7.2 regarding long-term emissions that need a separate interpretation.

Also, no incentive would exist to temporarily store the CO<sub>2</sub> e.g. in the wooden beams of the house in the above example.

On the other hand does temporary storage of CO<sub>2</sub> and the delayed emissions not consider that the CO<sub>2</sub> will in any case exert its full radiative effect, only later. For that reason carbon storage should only be considered quantitatively if this is explicitly required to meet the needs of the goal of the study. Otherwise, i.e. per default, temporary carbon storage and the equivalent delayed emissions and delayed reuse/recycling/recovery within the first 100 years from the time of the study shall not be considered quantitatively.

Note that the provided inventorying solution allows to do both with the same data set, as the storage / delay information is inventoried as separate inventory item:

### Modelling / inventorying provisions and examples:

To account for this and to at the same time ensure a transparent, plausible, and practice-applicable life cycle inventory, the following provisions are made:

As all emissions that occur within the next 100 years from the year of the analysis are inventoried as normal elementary flows, and all emissions that occur after 100 hundred years are inventoried as long-term emissions, simply a correction elementary flow of storage/delayed emission can be introduced for each contributing substance.

For fossil carbon dioxide this flow is named "Correction flow for delayed emission of fossil carbon dioxide (within first 100 years)" as "Emissions to air". It is measured in the flow property "Mass\*years" and the reference unit "kg\*a". The flow is to carry a GWP 100 impact factor of "-0.01 kg CO<sub>2</sub>-equivalents" per 1 kg\*a. The information about the assumed time of emission and the actual amount of the emission shall be documented in the unit process and hence available for review. Flows for biogenic (i.e. temporarily stored) carbon dioxide and methane, but also for other, fossil greenhouse gases with delayed emissions can be developed analogously.

These new elementary flows should be used in addition to the normal elementary flows including the flow "Carbon dioxide" as "Resources from air" that model the physical uptake of CO<sub>2</sub> into biomass.

A quantitative example: In the case of the above example of the end-of-life of a newly build house that is assumed to be demolished in 80 years, releasing the stored e.g. 4 tons of carbon in the 10 tons of wood beams as CO<sub>2</sub> would carry the following inventory flows and values:

- Inputs:
  - $4,000 \cdot 44 / 12 = 14,666$  kg "Carbon dioxide" as "Resources from air"
- Outputs:
  - $4,000 \cdot 44 / 12 = 14666$  kg "Carbon dioxide (biogenic)" as "Emissions to air"
  - $4,000 \cdot 44 / 12 \cdot 80 = 1,173,333$  kg\*a "Correction flow for delayed emission of biogenic carbon dioxide (within first 100 years)" as "Emissions to air"

In an impact assessment the result would be calculated as follows, with the biological uptake and release of the carbon dioxide cancelling each other out<sup>151</sup>, giving a correct resulting GWP 100 benefit for the 80 years storage, as  $1,173,333 \text{ kg*a} \cdot -0.01 \text{ kg CO}_2\text{-eq.}/(\text{kg*a}) = -11,733.33 \text{ kg CO}_2\text{-eq.}$

<sup>151</sup> Note that this works independently whether both have a GWP factor assigned or both not. That means that both modelling approaches can be supported by the mechanism of the CO<sub>2</sub> temporary storage flow.

Note that in the above example in total a negative Climate change effect is accounted for in the LCIA results, if considering the short-term perspective. If however the indefinite perspective would be considered, being the default perspective under the ILCD, the delayed emissions are not considered.

Note that this approach is applicable also to wood from primary forests that is used as wood product for a certain time: in case the forest is effectively removed and e.g. a pasture established this loss of C-storage is already addressed via the provisions for land transformation, i.e. not accounting for the CO<sub>2</sub> uptake from air. Equally is the calculation applicable to temporal storage of CO<sub>2</sub> in landfilled bio-based materials.

An example for delayed fossil CO<sub>2</sub> emissions: In the case of a delayed emission of fossil greenhouse gases, for clarity assuming the above example of the house would have e.g. 4 tons of fossil carbon in it, e.g. in insulation material and window frames, the example looks as follows:

- Inputs:
  - (none, as the CO<sub>2</sub> is fossil)
- Outputs:
  - $4,000 \cdot 44 / 12 = 14,666$  kg “Carbon dioxide (fossil)” as “Emissions to air”
  - $4,000 \cdot 44 / 12 \cdot 80 = 1,173,333$  kg\*a “Correction flow for delayed emission of fossil carbon dioxide (within first 100 years)” as “Emissions to air”

In an impact assessment the result would be calculated as follows, with the correction for the delayed emissions partly (here by - 80 % as the storage time is 80 years) compensating the release of fossil CO<sub>2</sub>, giving a correct resulting GWP 100 result for the 80 years delayed emission, as  $14,666 \text{ kg CO}_2\text{-eq.} + 1,173,333 \text{ kg*a} \cdot -0.01 \text{ kg CO}_2\text{-eq.}/(\text{kg*a}) = +2,932.67 \text{ kg CO}_2\text{-eq.}$

Hence, in comparison, the biogenic wood has still its full advantage of having extracted CO<sub>2</sub> from the atmosphere, while the delayed emissions are a benefit that both systems have in common (note that the difference between both examples is 14666 kg CO<sub>2</sub>-eq.).

The above works analogously with Nitrous oxide and other greenhouse gases.

Note that for the use stage of long-living goods the inventory would contain the integral of the emissions at different ages. This can be simplified in the common case that the use stage emissions are the same for all years: the total amount of use stage emissions would be multiplied with half of the assumed life time years.

The maximum amount of each correction flow that can be inventoried per kg delayed emission shall be 100 kg\*a. That is if the delayed emission takes place exactly 100 years into the future.

The correction flow shall be inventoried only if the emission is forecasted to take place at a maximum of 100 years into the future from the time of study. It shall not be inventoried if the emission takes place beyond the 100 years : An emission that takes place more than 100 years into the future shall be reflected in the inventory exclusively by inventorying the future emissions with the long-term emission elementary flows such as e.g. “Carbon dioxide, biogenic (long-term)” as “Emissions to air”. I.e. in that case no correction flow is required but would be wrong (see footnote <sup>155</sup>).



### Substitution / crediting for general cases of multifunctionality and for reuse / recycling / recovery that take place in the future

In analogy to rewarding delayed emissions of greenhouse gases with credits, also substitution when solving general cases of multifunctionality need to consider the delay, e.g. when crediting the benefit of a co-product that supersedes an alternative production. This is if the temporary storage is considered in the first place as it is required to meet the specific goal of the study.

The provisions for delayed greenhouse gas emissions apply analogously, i.e. respective "Correction flows..." should be inventoried with negative values. This results in a positive value (i.e. additional impact) for the Climate change impacts.

In analogy to treating general cases of multifunctionality, the delayed substitution for reused parts/goods, recycled materials and recovered energy needs to consider the delay.

#### 7.4.3.7.4 Long-term storage of potential emissions beyond 100 years

In the case the CO<sub>2</sub>-storage in goods, landfills or dedicated e.g. underground storages is longer than 100 years and the emission occurs somewhen in the future beyond 100 years, the maximum accountable CO<sub>2</sub>-removal of 100 years storage is inventoried as detailed above.

The quasi-permanent storage of CO<sub>2</sub> and generally of potential emissions in dedicated long-term storage forms (e.g. injection into former natural gas fields) is accounted for by inventorying no emissions, if the respective storage form can "guarantee" according to current scientific knowledge, and under independent external and qualified expert review, that the substance is not emitted for at least 100,000 years (number set by convention).

(Partial) emissions before that time are inventoried as long-term CO<sub>2</sub>-emission elementary flows; emissions within the first 100 years are inventoried as normal CO<sub>2</sub> emissions.

#### Provisions: 7.4.3.7 Future processes and elementary flows

Implicitly differentiated for attributional and consequential modelling.

- V) SHALL - **Separate inventory items for emissions more than 100 years into the future:** Emissions and other elementary flows that occur beyond the next 100 years from the time of the LCI/LCA study shall be inventoried separately (e.g. as "Emissions to water, unspecified (long-term)") from those that occur within the first 100 years (e.g. "Emissions to water, unspecified"). [ISO!]

Note that the ILCD reference elementary flows include a set of such long-term emissions to air, water and soil.

- VI) SHALL - **Uptake of "Carbon dioxide" by plants:** This shall be inventoried under "Resources from air". This applies to all photosynthetic organisms. [ISO!]

Note that both the uptake of CO<sub>2</sub> from the atmosphere and the release of both fossil and biogenic CO<sub>2</sub> should be assigned characterisation factors for the impact assessment. The lack of knowledge whether a carbon dioxide or methane emission is biogenic or fossil (i.e. inventoried as e.g. "Carbon dioxide (unspecified)") therefore does not render the results erroneous.

- VII) SHALL - **Inventory temporary carbon storage and delayed GHG emissions:** If "temporary carbon storage in bio-based goods" is considered, the temporary removal of carbon dioxide from the atmosphere, storage in long-living bio-based products or landfills, and delayed emission as CO<sub>2</sub> or CH<sub>4</sub> shall be modelled analogously to delayed emissions of fossil carbon dioxide and other greenhouse gases. The difference is that

### Provisions: 7.4.3.7 Future processes and elementary flows

for fossil emissions the uptake from the atmosphere is not considered, but only the delayed emission<sup>152</sup>. See also chapter 9 on interpretation and note that the temporary storage shall only be considered if explicitly required to meet the specific goal of the study. If this is the case, it shall both be modelled as follows: [ISO+]

VII.a) Special correction elementary flows shall be used to inventory the amount of CO<sub>2</sub> that is emitted in the future. This can be both due to temporary storage as embodied biogenic carbon in long-living and land-filled bio-based goods and due to processes with fossil GHG emissions that take place in the future. If this is done, the following correction flows shall be used:

VII.a.i) "Correction flow for delayed emission of biogenic carbon dioxide (within first 100 years)" and "Correction flow for delayed emission of fossil carbon dioxide (within first 100 years)", respectively. Both as elementary flows and classified on the general level as "Emissions", measured in the reference flow property "Mass\*years" of storage and the reference unit "kg\*a". Both flows shall carry a GWP100 impact factor of "-0.01 kg CO<sub>2</sub>-equivalents" per 1 kg carbon dioxide and 1 year of storage/delayed emission; this exclusively if "temporary carbon storage" is considered in the study.

VII.a.ii) "Correction flow for delayed emission of biogenic methane (within first 100 years)" and "Correction flow for delayed emission of fossil methane (within first 100 years)", respectively. Both as elementary flow and classified on the general level as "Emissions", measured in the reference flow property "Mass\*years" of storage and the reference unit "kg\*a". Both flows shall carry a GWP100 impact factor of "-0.25<sup>153,154</sup> kg CO<sub>2</sub>-"

<sup>152</sup> The logic behind accounting for biogenic carbon storage is that for the duration of storage the CO<sub>2</sub> is not exerting a radiative forcing. This makes sense only in case near-term radiative forcing is considered more relevant than future radiative forcing, as the later re-emitted biogenic CO<sub>2</sub> will still exert its full radiative forcing effect, only later. That is reflected by the commonly used one hundred years perspective for GWP100: the higher radiative forcing per unit (kg) of e.g. Methane and Nitrous oxide is weighted higher than the relatively lower radiative forcing per unit of CO<sub>2</sub>, always for 100 years. To reward the temporary removal of CO<sub>2</sub> from the atmosphere is fully equivalent to the effect of avoided radiative forcing due to delayed emission of fossil carbon dioxide, methane, nitrous oxide, and other greenhouse gases: While the uptake of CO<sub>2</sub> from the atmosphere is unique for biomass and considered in the impact assessment as negative impact, it does not matter whether one burns a block of wood or of plastic and releases the CO<sub>2</sub> as emission: both biogenic and fossil CO<sub>2</sub> are identically contributing to radiative forcing when emitted. For Climate change it is the same whether one keeps a piece of wood or of plastic unburned for e.g. 60 years. If the time when an emission takes place is considered for biomass it must also be considered for fossil materials. Some examples/aspects: Note that on a net basis temporarily stored biogenic carbon has a negative Climate Change impact: at 60 years storage of e.g. 1 kg CO<sub>2</sub>: CO<sub>2</sub> uptake (negative value -1 kg CO<sub>2</sub>-eq.) plus emission after 60 years (+1 kg CO<sub>2</sub>-eq.) minus the credit for 60 years temporary storage, = -1 + 1 - 0.6 = -0.6 kg CO<sub>2</sub>-equiv. in total. For delayed fossil emissions the net impact is always positive: CO<sub>2</sub> emission minus credit for 60 years delayed emission, e.g. for 1 kg CO<sub>2</sub> = 1 - 0.6 = 0.4 kg CO<sub>2</sub>-equiv. in total. Note that the difference between biogenic and fossil delayed emissions for the same time of delay is always the same (i.e. 1 kg CO<sub>2</sub>-equiv. difference per kg CO<sub>2</sub> emitted), rewarding both biogenic carbon storage and long-living products.

<sup>153</sup> This factor uses the IPCC GWP100 factors of 2007 by multiplying the base-value for carbon dioxide of 0.01 with the substance-specific factor (e.g. 25 for methane, 298 for nitrous oxide (laughing gas, N<sub>2</sub>O)). The substance-specific factor shall be adjusted in line with any ILCD recommendations on LCIA methods or updated factors from the IPCC if the former is not available.

### Provisions: 7.4.3.7 Future processes and elementary flows

equivalents" per 1 kg methane and 1 year of delayed emission; this exclusively if "temporary carbon storage" is considered in the study.

VII.a.iii) "Correction flow for delayed emission of nitrous oxide (within first 100 years)". As elementary flow and classified on the general level as "Emissions", measured in the reference flow property "Mass\*years" of storage and the reference unit "kg\*a". This flow is to carry a GWP100 impact factor of "-2.98<sup>153</sup> kg CO<sub>2</sub>-equivalents" per 1 kg nitrous oxide and 1 year of delayed emission; this exclusively if "temporary carbon storage" is considered in the study.

VII.a.iv) For other greenhouse gases analogous factors can be developed and used.

VII.b) The maximum amount of each correction flow that can be inventoried per kg delayed emission shall be 100 kg\*a. That is if the delayed emission takes place exactly 100 years into the future. The correction flow shall be inventoried only if the emission is forecasted to take place at a maximum of 100 years into the future from the time of study. It shall not be inventoried if the emission takes place beyond the 100 years<sup>155</sup>: An emission that takes place more than 100 years into the future shall be reflected in the inventory exclusively by inventorying the future emissions with the long-term emission elementary flows such as e.g. "Carbon dioxide, biogenic (long-term)" as "Emissions to air". I.e. in that case no correction flow is required but would be wrong.

VIII) **SHALL - Inventory future substitution analogous to delayed emissions:** The provisions for delayed greenhouse gas emissions as detailed above apply analogously for delayed reuse/recycling/recovery in case this is modelled with substitution. The same applies generally for substitution that occurs in the future. The respective "Correction flows..." shall be inventoried with negative values, i.e. debiting for the delay in the substitution. Note that only if "temporary carbon storage and delayed emissions" is required to meet the specific goal of the study the correction flows will be considered and result in an additional contribution to the Climate change impacts. [ISO+]

IX) **SHALL - Document details and assumptions on delayed emissions / substitution:** The information about the assumed storage time or time of future reuse/recycling/recovery and other cases of substitution, as well as the amounts and substances of the emissions in the unit process shall be documented and made available for review. [ISO+]

X) **SHALL - Provision for long-term / quasi-permanent storage of potential emissions:** The quasi-permanent storage of CO<sub>2</sub> and other potential emissions in

<sup>154</sup> Note that both fossil and biogenic Methane carry the same factor, as the uptake of the CO<sub>2</sub> by the plants is to be modelled explicitly in any case (see chapter 7.4.3.6.4) and the elementary flow carries a GWP factor of -1 kg CO<sub>2</sub>-equiv. per kg CO<sub>2</sub> uptake. Fossil and biogenic Methane would require different factors only if the uptake would not be modelled explicitly.

<sup>155</sup> The reason is that otherwise the LCIA results for the short-term perspective (first 100 years) would carry a full credit of negative climate change impacts while the long-term LCIA results carry the emission as it takes place beyond 100 years. If in results interpretation a short-term perspective is taken (and the long-term emissions excluded / discounted) an incorrect negative impact would be found.

### Provisions: 7.4.3.7 Future processes and elementary flows

dedicated long-term storage forms (e.g. injection into former natural gas fields) shall be accounted for by inventorying no emissions at all, if the respective storage form can guarantee that it is not emitted to the atmosphere for at least 100,000 years (duration set by convention). [ISO+]

- XI) **SHALL - Document details and assumptions on long-term / quasi-permanent storage:** The information about the storage form and assumed storage time shall be concisely documented and made available for review. This documentation shall be done via a respective waste inventory flow. [ISO+]

Note: The other inventory work is done as usual: i.e. inventorying emissions that occur within 100 years from present with the normal elementary flows (e.g. "Methane, biogenic" as "Emissions to air").

Note that only if "temporary carbon storage" is considered in the study, in the later interpretation the results shall be analysed individually with and without the credit, showing explicitly the effect of the credit for storage/delayed emissions.

Note that if the above provisions cannot be fully met, this shall be explicitly considered when reporting achieved data quality and when interpreting the results of LCA studies. Note that LCI data sets' inventories that do not meet the above requirements are not compliant with the ILCD nomenclature.

### 7.4.3.8 Reminder flows

(No corresponding ISO 14044:2006 chapter)

#### Introduction and overview

Reminder flows are no own category of flows, but an additional classification applicable to any flow. It is excluding it from the impact assessment and system modelling, while keeping it in the inventory as a "reminder" also when creating LCI results.

Reminder flows can be used for product flows such as "electricity, reminder flow" to keep the information in the LCI results what is the overall amount of electricity used over the life cycle. Such is sometimes required for certain life cycle applications such as Environmental Product Declarations (EPD). Or it can be used for indicator flows such as "VOC, reminder flow, not impact relevant" that is inventoried in addition to the single emissions which it is composed of.

Presently "reminder flows" are used in few LCA software systems and databases, but this approach is seen very beneficial, as explained above. It is implemented as an option in the ILCD reference format where individual Input/Output flows can be marked as "Reminder flow".

It is to be stressed again that reminder flows do not have any relevance regarding classical LCI results or LCIA results information, i.e. must not carry any LCIA impact factors and are not to be connected with up-stream or down-stream processes.

Such reminder flows should have an own, specific name to lower the risk of double counting in the inventory.

### Provisions: 7.4.3.8 Reminder flows

- I) **MAY - Use reminder flows to keep original information for specific purposes:** It is recommended to use reminder flows to inventory the original information of split measurement indicators and sum flows (see 7.4.3.2). They may be used to keep other

flows in LCI results inventories for information purposes. [ISO+]

- II) **SHALL - Exclude reminder flows from impact assessment:** Reminder flows shall not carry an LCIA impact factor. [ISO+]
- III) **SHALL - Clearly identify reminder flows in the flow name:** The fact of being a reminder flow shall also be identified in the flow name (e.g. "VOC, reminder flow, not impact relevant"). [ISO+]

Note that if the above provisions cannot be fully met, this shall be explicitly considered when reporting achieved data quality and when interpreting the results of LCA studies. Note that LCI data sets' inventories that do not meet the above requirements are not compliant with the ILCD nomenclature.

## 7.4.4 Overarching method provisions for specific process types

(Refers to aspects of ISO 14044:2006 chapters 4.2.3.5 and 4.3.2.2)

### 7.4.4.1 Modelling agro- and forestry systems

(Refers to aspects of ISO 14044:2006 chapters 4.2.3.3.3 and 4.2.3.5)

#### Introduction

Industrial production processes typically have a well defined and controlled boundary between the technosphere and the ecosphere and are operated with equally well-defined or at least controlled (and hence measurable) operational parameters. Agricultural, forestry and similar (e.g. fish farming) production systems largely lack this. They therefore typically need to include different, model-based approaches for data collection. The common needs of these systems of the economy's primary sector need specific guidance on some specific aspects:

#### System boundaries

Similar to modelling waste, also for agricultural and forestry systems the interpretation of the system boundary differs in LCA practice: a clear separation between emissions to soil, water and air in inventories of agricultural and forestry production requires a clear guidance in inventorying, separating correctly and consistently between the technosphere and the ecosphere:

Pesticide and fertilizer applications are no emission, but part of the product flows within the (man-managed) technosphere. The emissions are the flows from the e.g. field or forest to the ecosphere via leaching and run-off of e.g. Nitrates and Phosphate, off-drift of pesticides during application and their volatilisation from plant and soil surface etc.

The amount of these emissions has to be modelled case-specific as they can differ extremely: plant-uptake, site-properties, climate and geographical conditions, as well as farming practice determine the conversion of e.g. applied Ammonium nitrate fertiliser to nitrate emissions to water and to NH<sub>3</sub> and N<sub>2</sub>O emissions to air.

Equally the uptake of heavy metals into the harvested goods and removal from the site are elementary flows and are to be inventoried individually for the given case.

At the same time, some inputs to soil do not leave the technosphere via leaching etc., but are accumulated in the soil, such as e.g. cadmium that typically accompanies most phosphate fertilisers at least to some extent. The amount of e.g. cadmium within the phosphate fertiliser that is applied to the field is directly inventoried as emission to agricultural soil.

Also a part of the nutrients from fertilisation may remain in the field after harvest and serves as input to the next crop, hence crosses the system boundary within the technosphere over time. In this case the substance is a co-function of the preceding crop, making that process multi-functional. The general provisions for solving multifunctionality apply.

Net accumulation or depletion of a substance is hence to be recorded in the inventory, disregarding the nature of this substance (agrochemical, nutrient, heavy metal, carbon, etc.) and to be correctly considered in the system model or the impact assessment, as applicable.

### **Carbon stock changes and CO<sub>2</sub> emissions resulting from land use and land transformation**

Land transformation and land use often change the amount of soil organic carbon: after transformation from land occupations with higher soil organic carbon (e.g. forests) to those with a lower level (e.g. agriculture), over a number of years a new equilibrium is reached<sup>156</sup>. The differences in soil organic carbon is mostly emitted as CO<sub>2</sub>. In turn, land use changes can also result in net accumulation of soil organic carbon, which is sequestered from the air as CO<sub>2</sub>.

To account for that effect and for the release/binding of climate change related gases (especially CO<sub>2</sub>, but potentially others) caused by land use and land use changes, the most recent data and emission factors provided by the Intergovernmental Panel on Climate Change (IPCC) should be used, unless more accurate, specific data is available. For calculating these IPCC-based factors from the basic land use information (e.g. climate zone, soil type, land use type, etc.), guidance, data, and default factors related to CO<sub>2</sub> emissions / binding are given in annex 13.

The following text provides guidance on assigning or sharing the inventory to the land uses' functions after the transformation:

The land use transformation related direct and indirect inventory (e.g. machine use, peak emissions occurring e.g. when the forest biomass is incinerated, long-term CO<sub>2</sub> emissions from soil carbon) shall be allocated to the land use functions (e.g. crops) of the following years by area and year.

Two cases are to be differentiated:

- a) inventory items that occur over a longer period than one year (e.g. CO<sub>2</sub> emissions from loss of soil organic carbon due to biodegradation of e.g. humus)
- b) inventory items that occur in direct context of the transformation and not longer than one year afterwards (e.g. machine use during conversion and peak emissions e.g. from biomass burning)

**For case a)**, and for both attributional and consequential<sup>157</sup> models, the inventory should be assigned to the land use functions in proportion to the inventory that occurs during the

---

<sup>156</sup> It is important to note that each even minor change in land use (e.g. cropping wheat where the year before sugar beets were cropped) is formally a land transformation. It depends on how different the uses are, whether they effectively result in changes e.g. of the long-term soil organic carbon equilibrium. The following examples are assuming that for the different crops named to be produced after transformation, do not change this equilibrium, i.e. do not imply each another land transformation. Otherwise, a new transformation step would need to be calculated. This would then need to consider that the equilibrium has not yet been achieved and hence start with the interim achieved soil organic carbon level and considering the new equilibrium for the next land use. To work out the details might be a topic e.g. for a sector-specific guidance document or Product Category Rule (PCR).

<sup>157</sup> Note that indirect land use changes are a topic under detailed consequential modelling; see chapter 7.2.4.

time the land use function is occupying the land or otherwise blocking it for other uses (e.g. 1 year fallow as part of crop rotations). For loss / binding of CO<sub>2</sub> in form of soil organic carbon, towards reaching the equilibrium of the land use after transformation, a default period of 20 years shall be assumed (see Formula 1). This is, unless it can be demonstrated that the period during which about 90 % the main losses / binding occurs is significantly longer or shorter for the given case. In that case, that duration shall be applied and Formula 2 be used.

For simplification, the total loss shall be assumed to occur linearly with time over the period until the about 90 % loss / binding towards the new equilibrium have been reached; this is assumed, as said above, to occur per default over 20 years. I.e. a triangle-shaped allocation pattern shall be used over the considered years (as expressed in Formula 1). This approach is giving higher burdens to the first years after transformation. This is motivated under consequential modelling by the closer link to the decision to convert that land. Under attributional modelling, the reasoning is that that amount is inventoried, which physically occurs<sup>158</sup> in the period of the land use (including periods of blocking it for other uses).

If the initial years after transformation are without harvest (e.g. as typical for in plantations), the inventory shall be assigned to the first harvest / function of the land use after transformation.

If only one kind of crop is harvested (e.g. fruits of a 25 year running fruit tree plantation without wood use), the entire inventory can be allocated to the total amount of the crop, independently of the specific year when the crop has been harvested; i.e. each kg has the same inventory.

In the case more than one crop is harvested per year, the calculated inventory for that year (see below) shall be linearly allocated between these crops over the time of that year that they use the land or block it for other uses; i.e. for simplification no further differentiation needs to be made between months earlier and later in that year.

If the land use function (e.g. harvesting of wood) occurs after the considered period (here: 20 years), the entire inventory shall be assigned to that function, i.e. not only the share of that year, i.e. the inventory of preceding years is assigned to the crops harvested later, as otherwise it would be lost / not accounted for.

If a joint production e.g. of annual crops and a final crop occurs (e.g. latex during the years and rubber wood at the end), the final crop should be considered to have been harvested after half the total period.

The % share of the total inventory that shall be allocated to a given year (assuming the crop occupies that land for the full year or otherwise prevents its use for a full year), is then calculated using Formula 1.

$$\text{Formula 1} \quad X = \frac{100 * 2}{20 + 1} * \frac{20 - i}{20}$$

- X = % of inventory to be allocated to the year *i* of the analysed crop
- 20 = number of years after transformation over which the inventory is to be allocated, i.e. until when 90 % of the losses / bindings of the CO<sub>2</sub> from / into the soil have occurred. The number of years is counted from the transformation onwards.

<sup>158</sup> It is noted that the actual distribution over time is about exponential. The triangle is hence a simplification.

- $i$  = number of years after transformation during which the analysed crop is cropped; the first year after transformation is year  $i = 0$  (Additional condition: if  $i > 20-1$  then  $X = 0$ , i.e. nothing shall be allocated after 20 years).

Example: After transformation of a former land use to permanent agriculture, after 2 years the first crop might be harvested (e.g. pineapple). In year 3 e.g. corn is harvested, and in year 4 e.g. papaya. Applying Formula 1, the pineapple receive for the first year  $(100 \cdot 2) / (20+1) \cdot (20-0) / 20 \% = 200 / 21 \cdot 1 \% = 9.5 \%$  plus for the second year  $(100 \cdot 2) / (20+1) \cdot (20-1) / 20 \% = 200 / 21 \cdot 0.95 \% = 9 \%$ , in sum 18.5 % of the total CO<sub>2</sub> inventory related to the transformation. The corn of year 3 receives  $(100 \cdot 2) / (20+1) \cdot (20-2) / 20 \% = 200 / 21 \cdot 0.9 \% = 8.6 \%$ , the papaya of year 4  $(100 \cdot 2) / (20+1) \cdot (20-3) / 20 \% = 200 / 21 \cdot 0.85 \% = 8.1 \%$ , and so on. In sum over 20 years, 100 % are assigned to the various land use functions.

For land uses during the considered period but that are shorter than one year, the inventory shall be linearly shared among the uses according to their duration of using or blocking the land.

The data, tables, factors and formula for calculating this CO<sub>2</sub> inventory that is to be shared as detailed above, is given in annex 13.

**For case b), and both under attributional and consequential modelling:** the subsequent years of land use e.g. for agriculture of different crops can be considered to be analogous to the reuse/further use e.g. of refillable bottles or recycled metals. I.e. they each share the same share of the "production" inventory (here: the land transformation) per function (here: year of land use). Also under consequential modelling, the reuse/further use of the land leads to the same burdens are shared per function provided (see the example on further use of a metal table in the "Terms and concepts: Recyclability substitution approach" box in annex 14.5.2).

Per default and set as convention for sub-annual, annual and bi-annual crops, the total amount of uses over which the "production" inventory of the land transformation is to be shared shall be 20 years<sup>159</sup>. This is the same duration over which by default the soil organic carbon changes are modelled. This is unless the foreseeable duration of the transformed land use is shorter, ending foreseeably with nature or no use other than short-term/managed fallow (e.g. slash-and-burn agriculture of 3 years use before abandoning). Or the foreseeable minimum use is longer (e.g. plantations with 30 years plantation cycle). In that case, that duration of one plantation / use cycle shall be used.

The % share of the total inventory that shall be assigned to a given year of land use (assuming the crop occupies that land for the full year or otherwise prevents its use for a full year), is then proportional to the duration of land use / blocking it for other uses. I.e. other than for the preceding case of soil carbon changes it does not depend how long after transformation the land use occurs, as long as it is within the period that is considered as defined above<sup>160</sup>.

<sup>159</sup> This and the following settings assume that the decision to change the land use is not motivated for the next single crop year, but over a longer period.

<sup>160</sup> The reasoning that the emissions that occur in year 0 are linearly shared by the following land uses over several years, while the emissions that occur over a longer period are shared in a triangular shape, i.e. giving a higher share to the land use directly following the transformation, is as follows: The "peak" inventory of transformation is equivalent to a production inventory, e.g. of a refillable bottle. The emissions that occur over a longer period are still related to the transformation, but it depends on the specific land use in a given year, whether the e.g. soil organic carbon loss is stopped by e.g. better land management, i.e. is an operational emission (similar to washing a refillable bottle). Hence it is to be inventoried as and when it occurs.



Example: if the agricultural production of slash-and-burn for three years' harvests bananas in the first year and manioc in the second and cassava in the third year, the harvests of bananas, manioc and cassava receive each  $1/3 = 33.3\%$  of the inventory (assuming here for simplification that they use the land each for one year).

**For both cases a) and b):**

In the case of co-products, the same provisions apply as for general cases of multifunctionality under attributional modelling (see chapter 7.9) and consequential modelling (see chapter 7.2.4.6), respectively. If the natural goods from the converted land (e.g. wood) are also at least partly used, they shall be considered one function as part of the multifunctional system.

The same provisions apply analogously to land transformation between other than agricultural, pastoral or forestry uses. The focus is put here on these processes, as for these the effects or often highly relevant for the LCI results.

**Other emissions resulting from land use and land transformation (with equilibrium, excluding nutrients)**

Other emissions that occur over a longer period than one year after transformation, but similar as the soil organic carbon in an exponential way, should be measured or modelled for the given case or using authoritative sources with generic data if available. This formula is also used if under case "a)" 90 % of the equilibrium of the soil organic carbon is reached after more or less then the 20 years that are set per default (see more above in this chapter).

The % share of the total inventory that shall be assigned to a given year (assuming the crop occupies that land for the full year or otherwise prevents its use for a full year), is then calculated using Formula 2, being the general form of Formula 1:

$$\text{Formula 2} \quad X = \frac{100 \cdot 2}{n+1} * \frac{n-i}{n}$$

- $X$  = % of inventory to be allocated to the year  $i$  of the analysed crop
- $n$  = number of years after transformation over which the inventory is to be allocated, i.e. until when 90 % of the losses / bindings have occurred. The number of years is counted from the transformation onwards.
- $i$  = number of years after transformation during which the analysed crop is cropped; the first year after transformation is year  $i = 0$  (if  $i > n-1$  then  $X = 0$ , i.e. nothing shall be allocated after the number of considered years).

Example: Inventorying the XY leaching losses after land transformation of tropical forest by slash-and-burn agriculture: 90 % of the leaching may occur over 3 years (value illustrative only). In these three years, the following is cropped and harvested: bananas in the first year, and manioc in the second year, and cassava in the third year. The bananas harvest receives  $(100 \cdot 2)/(3+1) \cdot (3-0)/3 \% = 50 \cdot 1 \% = 50\%$  of the total inventory related to the transformation. The manioc of the second year receives  $(100 \cdot 2)/(3+1) \cdot (3-1)/3 \% = 50 \cdot (2/3) \% = 33.3\%$  and the cassava  $(100 \cdot 2)/(3+1) \cdot (3-2)/3 \% = 50 \cdot (1/3) \% = 16.7\%$ , in sum 100 %.

Note that the total amount of the loss of XY and the actual duration of the main losses until about 90 % of the equilibrium of the land use are reached need to be identified first.

**Emissions without an equilibrium**

Emissions that do not have an equilibrium or that reach that state in a not exponential way, (e.g. soil erosion) need to be modelled differently, while following an analogous

reasoning as the other inventory items addressed in this chapter. E.g. surface erosion by water and wind and related mass flow transfer of these substances together with the eroded soil to waterways or air shall be inventoried as "Emission to fresh water" or "Emission to air", respectively. These losses are directly related to the operation of the cropping process, hence belong to its inventory.

### Nutrients as emissions and as product flows

Note that emissions especially of  $\text{NO}_3^-$ ,  $\text{PO}_4^{3-}$  and other substances that are part of the nutrient system of the land and crop should be modelled as they occur during the respective land use. In fact are these nutrients a product flow input from the preceding land use and hence a co-function that needs to be solved as other cases of multifunctionality.

Any remaining nutrients such as nitrate in the field are a co-product of the crop are an input for the production of the next crop. These cases of multifunctionality shall be solved in principle via system expansion (consequential modelling) or allocation (attributional modelling), applying the same provisions are foreseen for other cases of multifunctionality; see 7.2.4.6 and 7.9, respectively.

### Temporary removal of carbon dioxide from the atmosphere by plants and release at end-of-life

See chapter 7.4.3.7.3.

### Indirect land use changes

Indirect land use is an issue under consequential modelling that applies to all kinds of land uses and is hence addressed in chapter 7.2.4.4.

#### Provisions: 7.4.4.1 Modelling agro- and forestry systems

Applicable to Situation A, B, and C, differentiated.

Differentiated for attributional and consequential modelling.

- I) **SHALL - Agro- and forestry systems:** Their modelling shall be done as follows: [ISO!]
  - I.a) **Inventory net interventions:** Only the net interventions related to human land management activities shall be inventoried. Interventions that would occur also if the site was unused shall not be inventoried (e.g. not the basic Nitrate leaching resulting from N input via rain):
    - I.a.i) **Reference system under attributional modelling:** The "no use" reference system shall be the independent behaviour of the site, starting from the status of the land at that moment when the area of the analysed system is prepared for the modelled system.
    - I.a.ii) **Indirect land use under consequential modelling:** The indirect land use (mix) shall be modelled (provisions see chapter 7.2.4.4); net interventions may need to be modelled for those indirect land uses / transformations.
 

Note that land transformation happening in the past may need to be allocated to the analysed system.
  - I.b) **Model site as part of the technosphere:** Of the applied fertilisers and agrochemicals (e.g. fungicides) only the amounts that leave the site (i.e. the field, plantation, managed forest etc.) shall be inventoried as emissions to air or water,

### Provisions: 7.4.4.1 Modelling agro- and forestry systems

as appropriate.

I.c) **Carried over nutrients as co-functions:** Any remaining nutrients such as N in crop residues are a co-product of the crop are an input for the production of the next crop. These cases of multifunctionality shall be solved in principle via system expansion (consequential modelling) or allocation (attributorial modelling), applying the same provisions are foreseen for other cases of multifunctionality; see 7.2.4.6 and 7.9, respectively. Also emissions especially of Nitrate, Phosphate and other substances that are part of the nutrient system of the land and crop should be modelled as they occur during the respective land use.

I.d) **Model immobile substances to cross the system boundary over time:** Strongly soil-bound heavy metals and Persistent Organic Pollutants (POPs) that remain in the site for many decades shall be inventoried as "Emissions to soil, unspecified". Leaching of these substances to the groundwater shall not be inventoried additionally, but is covered via the impact assessment of this emission to soil. In contrast, surface erosion by water and wind and related mass flow transfer of these substances together with the eroded soil to waterways or air shall be inventoried as "Emission to fresh water" or "Emission to air", respectively. These losses are directly related to the operation of the cropping process, hence belong to its inventory.

Note that the amount inventoried as emission to soil is to be reduced by the respective erosive losses. Double-counting shall be avoided.

I.e) **Model emissions form land use and transformation:** Carbon dioxide and other emissions resulting from land use and land transformation shall be modelled as follows, for both attributorial and consequential modelling:

I.e.i) **CO<sub>2</sub> emissions:** These shall be calculated using the most recent Intergovernmental Panel for Climate Change (IPCC) factors per default, unless more accurate, specific data is available. Other, relevant inventory items should be measured or modelled for the given case or using similar authoritative sources, if available. Formulas for assignment to different subsequent land uses see below. The data, tables, factors and formula for calculating this CO<sub>2</sub> inventory that is to be shared as detailed below, is given in annex 13.

I.e.ii) **Two cases of inventory related to land transformation:** The land transformation related direct and indirect inventory shall be allocated to the following crops by used/occupied land area and duration of cropping, as follows. Two cases are to be differentiated: **a) inventory items that occur over a longer period than one year, exponentially reaching a new quasi-equilibrium** (e.g. CO<sub>2</sub> emissions from loss of soil organic carbon due to biodegradation of e.g. humus). **b) inventory items that occur in direct context of the transformation and not longer than one year afterwards** (e.g. machine use during conversion and peak emissions e.g. from biomass burning)

I.e.ii.1) **For case a),** and for both attributorial and consequential models, the inventory should be assigned to the land use functions in proportion to the inventory that occurs during the time the land use function is occupying the land or otherwise

### Provisions: 7.4.4.1 Modelling agro- and forestry systems

- blocking it for other uses (e.g. include 1 year fallow as part of crop rotations). For loss / binding of CO<sub>2</sub> in form of soil organic carbon, towards reaching the equilibrium of the land use after transformation, a default period of 20 years shall be assumed. This is meant to reflect about 90 % the main losses / binding.
- I.e.ii.2) For simplification, the total loss shall be assumed to occur in a triangularly shaped distribution with time over the period until the about 90 % loss / binding towards the new equilibrium have been reached. Formula 1 shall be used to allocate the calculated total emission/binding to the crops; if the above default period can be demonstrated to be different from 20 years, Formula 2 shall be used instead.
- I.e.ii.3) Formula 1 
$$X = \frac{100 * 2}{20 + 1} * \frac{20 - i}{20}$$
- X = % of inventory to be allocated to the year i of the analysed crop
  - 20 = number of years after transformation over which the inventory is to be allocated, i.e. until when 90 % of the losses / bindings of the CO<sub>2</sub> from / into the soil have occurred. The number of years is counted from the transformation onwards.
  - i = number of years after transformation during which the analysed crop is cropped; the first year after transformation is year i = 0 (Additional condition: if i > 20-1 then X = 0, i.e. nothing shall be allocated after 20 years).
- I.e.ii.4) If the initial years after transformation are without harvest (e.g. as typical for in plantations), the inventory shall be assigned to the first harvest / function of the land use after transformation.
- I.e.ii.5) If only one kind of crop is harvested (e.g. fruits of a 25 year running fruit tree plantation without wood use), the entire inventory can be allocated to the total amount of the crop, independently of the specific year when the crop has been harvested; i.e. each kg has the same inventory.
- I.e.ii.6) In the case more than one crop is harvested per year, the calculated inventory for that year shall be linearly allocated between these crops over the time of that year that they use the land or block it for other uses; i.e. for simplification no further differentiation needs to be made between months earlier and later in that year.
- I.e.ii.7) If the land use function (e.g. harvesting of wood) occurs after the considered period (here: 20 years), the entire inventory shall be assigned to that function, i.e. not only the share of that year, i.e. the inventory of preceding years is assigned to the crops harvested later, as otherwise it would be lost / not accounted for.
- I.e.ii.8) If a joint production e.g. of annual crops and a final crop occurs

### Provisions: 7.4.4.1 Modelling agro- and forestry systems

(e.g. latex during the years and rubber wood at the end), the final crop should be considered to have been harvested after half the total period.

- I.e.ii.9) The % share of the total inventory that shall be allocated to a given year (assuming the crop occupies that land for the full year or otherwise prevents its use for a full year), is then calculated using Formula 1 (see above).
- I.e.ii.10) For land uses during the considered period but that are shorter than one year, the inventory shall be linearly shared among the uses according to their duration of using or blocking the land.
- I.e.ii.11) **For case b)** and per default for sub-annual, annual and bi-annual crops, the total amount of uses over which the "production" inventory of the land transformation is to be shared shall be 20 years. This is unless the foreseeable duration of the transformed land use is shorter, ending foreseeably with nature or no use other than short-term/managed fallow (e.g. slash-and-burn agriculture of 3 years use before abandoning). Or the foreseeable minimum use is longer (e.g. plantations with 30 years plantation cycle). In that case, that duration of one plantation / use cycle shall be used.
- I.e.ii.12) The % share of the total inventory that shall be assigned to a given year of land use (assuming the crop occupies that land for the full year or otherwise prevents its use for a full year), is then proportional to the duration of land use / blocking it for other uses. I.e. other than for the preceding case of soil carbon changes it does not depend how long after transformation the land use occurs, as long as it is within the period that is considered as defined above.
- I.e.ii.13) **Other emissions resulting from land use and land transformation (with equilibrium, excluding nutrients):**
- I.e.ii.14) Other emissions that occur over a longer period than one year after transformation, but in an exponential way, should be measured or modelled for the given case or using authoritative sources with generic data if available. The following Formula 2 can be applied, being the general form of Formula 1:
- I.e.ii.15) The % share of the total inventory that shall be assigned to a given year (assuming the crop occupies that land for the full year or otherwise prevents its use for a full year), is then calculated using Formula 2.
- I.e.ii.16) Formula 2 
$$X = \frac{100 * 2}{n+1} * \frac{n-i}{n}$$
- X = % of inventory to be allocated to the year i of the analysed crop
  - n = number of years after transformation over which the inventory is to be allocated, i.e. until when 90 % of the losses

### Provisions: 7.4.4.1 Modelling agro- and forestry systems

/ bindings have occurred. The number of years is counted from the transformation onwards.

- $i$  = number of years after transformation during which the analysed crop is cropped; the first year after transformation is year  $i = 0$  (if  $i > n-1$  then  $X = 0$ , i.e. nothing shall be allocated after the number of considered years).

I.e.ii.17) Note that the total amount of the loss of XY and the actual duration of the main losses until about 90 % of the equilibrium of the land use are reached need to be identified first.

I.e.ii.18) **Emissions of items without an equilibrium:**

I.e.ii.19) Emissions that do not have an equilibrium state or that reach that state in a not exponential way, (e.g. soil erosion) need to be modelled differently, while following an analogous reasoning as the other inventory items addressed in this chapter. These losses are directly related to the operation of the cropping process, hence belong to its inventory.

I.e.iii) If the natural goods from the converted land are also at least partly used (e.g. harvested primary forest wood), they shall be considered one function as part of the multifunctional system.

I.e.iv) The same provisions apply analogously to land transformation between other than agricultural, pastoral or forestry uses.

I.e.v) Emissions that do not have an equilibrium state or reach that state in a not exponential way, (e.g. soil erosion) need to be modelled differently, while following an analogous reasoning as the other inventory items addressed in this chapter.

Temporary removal of carbon dioxide from the atmosphere by plants and release at end-of-life: see chapter 7.4.3.7.3.

Indirect land use is an issue under consequential modelling and is in chapter 7.2.4.4.

Note that if the above provisions cannot be fully met, this shall be explicitly considered when reporting achieved data quality and when interpreting the results of LCA studies.

### 7.4.4.2 Modelling waste treatment

(Refers to aspects of ISO 14044:2006 chapters 4.2.3.3.3)

#### Overview

This chapter focuses on modelling waste for deposition, the system boundary technosphere / ecosphere, and inventorying convention for waste flows.

See also the specific provisions for modelling reuse, recycling and recovery under attributional modelling in annex 14.4 and consequential modelling in annex 14.5.

#### Complete modelling of waste management to elementary flows

Waste flows (e.g. household waste, end-of-life products, wastewater from a process, tailings from ore processing, and the like) are no elementary flows but are flows inside the technosphere. Therefore their further management and treatment needs to be modelled until

the related elementary flows cross the system boundary. This is the same as for any other process in the system.

Waste flows therefore shall not be left as such in the inventory, with one exception: for radioactive waste, so far no agreed modelling is available; radioactive waste flows are to remain in the inventory and are to be differentiated at least into highly, medium and low radioactive waste. If other waste flows are left in the inventory, this shall be clearly documented and the user be advised to complete the model. Otherwise the lack of accuracy and completeness shall be considered in the results interpretation.

### **Frequent errors: Incomplete modelling of waste management**

In LCA practice it can still often be observed that relevant amounts of waste flows are kept in the inventory, i.e. the LCI work and hence LCIA results are incomplete. That should be avoided or otherwise must be reported and explicitly considered in interpretation of results.

Sometimes this is caused by an unclear/inappropriate definition of the system boundary between technosphere and ecosphere (see chapter 6.6). This results in errors such as e.g. inventorying tailings from ore processing as such instead of modelling the leaching of e.g. sulphuric acid and metals emissions from these tailings.

A complete modelling of all relevant waste flows - e.g. using generic or sector-average waste management models - is a single means that can help substantially to complete existing inventory data.

Optionally, waste flows can additionally be kept in the inventory as "Reminder flows" that are clearly identified as not being part of the normal (i.e. impacting) inventory. Note that this option is only as additional information for reporting purposes as sometimes required by individual EPD systems, but is not substituting the complete modelling of waste management to the elementary flows.

### **Inventorying convention for waste**

Modelling of waste treatment can be done in two ways:

- either by inventorying it as a physical flow of waste in the output (i.e. in sense of the material flow direction, as for all material and good flows along the supply-chain),
- or as service flow in the input (i.e. in sense of a purchased service, as incurred cost on the input side, the same as for other services).

It is recommended to model generated waste in the output of processes, as this results in less confusion especially when calculating process mass and element balances, but also already during modelling and depicting the systems flow chart, as well as in external communication.

### **Littering / discarding to nature**

For littering of complex goods such as for example batteries, the emissions from the battery shall be modelled/estimated and inventoried as elementary flows. I.e. not the "battery" itself would be the emission flow but the emissions that effectively leave the battery to the surrounding soil, water and air. This is necessary as complex goods cannot be well captured with LCIA methods, but remain an inventory issue that needs specific modelling of the littering situation. Hence, although the littered goods ends up in the environment, it is modelled as part of the technosphere. In line with the definition of interventions, only single substances are the emission elementary flows that are inventoried.

It is recommended to keep the information of the littered good in the inventory as reminder flow (see chapter 7.4.3.8). The modelled assumptions of the releases shall be documented.

Preferably, the process of the behaviour of the littered good is modelled as separate unit process.

An example is a physical effect that materials that may exert on wildlife e.g. if littered to rivers or the sea. In that case, the effect is to be inventoried in a respective elementary flow, as required by the applied LCIA method (next to e.g. emissions that may take place in addition).

#### Provisions: 7.4.4.2 Modelling waste treatment

- l) **SHALL - Waste and end-of-life product deposition:** This shall be modelled as follows: [ISO!]
  - l.a) **Model waste management completely:** Waste and waste water treatment shall be modelled consistently to the boundary between technosphere and ecosphere; otherwise this shall be clearly documented and be explicitly considered in later interpretation. This modelling includes all treatment steps up to and including disposal of any remaining waste to waste deposits or landfills and inventorying the emissions from these sites to/from the ecosphere. Two exceptions are radioactive wastes and wastes in underground deposits (e.g. mine filling), which should be kept as specific waste flows in the inventory, unless detailed, long-term management and related interventions have been entirely modelled also for these.
  - l.b) **Modelling discarding of goods into nature:** For unmanaged landfilling, discharge, and littering (i.e. discarding goods individually into nature) the related individual interventions that enter the ecosphere shall be modelled as part of the LCI model. This also applies analogously to other interventions than emissions, if the used LCIA method covers such. The littered / landfilled good should be additionally inventoried as reminder flow.
  - l.c) **Modelling waste as output:** Waste flows should be modelled following the material flow logic. That means inventorying the waste on the output side of those processes where it is generated (e.g. production waste or end-of-life product as output of the use stage). For waste management processes that means that the waste flows should accordingly be modelled on the input side if the process, with any potentially produced secondary goods and remaining wastes being on the output side. This eases mass and element balancing. For cost calculation purposes, the cost of the waste treatment service may be assigned to the waste flow as additional flow property.

Note: The use of generic waste treatment models / processes may be considered to limit time and resources required for data collection.

### 7.4.5 Naming and other conventions

(Refers to aspects of ISO 14044:2006 chapters 4.3.2.2 and 4.3.2.3)

Equally common across attributional and consequential modelling are a number of conventions around nomenclature and other conventions. These identify and define the same commonly required objects (e.g. “Carbon dioxide” as “Emission to air”, “kg” as unit for the property “Mass”, etc.).

This is a pre-requisite for being able to combine and integrate inventory data sets from different data developers to systems and LCA studies and to link LCIA methods correctly to



the resulting inventory results. Otherwise multiple occurrence of flows, incomplete impact assessment, and fundamental incompatibility of the inventories would be the consequence. These conventions also provide the basis for proper identification and naming of e.g. new elementary flows, including the need for CAS No and the like, their measurement in appropriate and compatible units and the like.

While most elementary flows are reported in the flow property “mass” and expressed in measurement units such as “kg”, some elementary flows are to be reported as “lower calorific energy value” and expressed in the unit “MJ” (e.g. for energy resources), others as “ionising radiation activity” in the unit “kBq” (for emitted radioactive isotopes). Product and waste flows are measured in the individually identified, appropriate flow property and unit. The separate document “Nomenclature and other conventions” gives the detailed provisions on this.

The set of ILCD reference elementary flows, flow properties and unit groups implement this nomenclature guidance document and provide a ready-made set of 19000+ elementary flows and the commonly required flow properties and unit groups.

For more details on naming of flows and other conventions see the document on “Nomenclature and other conventions”<sup>161</sup>.

### Provisions: 7.4.5 Naming and other conventions

- I) **SHALL - Elementary flows:** [ISO+]
  - I.a) **Use ILCD reference elementary flows:** The 19000+ pre-defined ILCD reference elementary flows, flow properties (named “properties” in ISO/TS 14048 and “quantities” in ISO 31) and unit groups shall be used per default, if available.
  - I.b) **Define new elementary flows consistently:** New elementary flows shall be created meeting the methodological requirements of this document (see chapter 7.4.3). They shall per default be measured in flow properties (e.g. upper or lower calorific value) and units (e.g. MJ or kWh) applying the guidance given in the separate document “Nomenclature and other conventions”. Exceptions are only possible if a different unit (e.g. one year of production) is explicitly required for the intended applications; in that case the use of not ILCD-compliant units shall be brought to the awareness of the data set user.
  - I.c) **Use ILCD elementary flow categories:** New elementary flows shall be classified in the elementary flow categories and sub-categories as defined in the guidance document “Nomenclature and other conventions” (e.g. “Emissions to fresh water”, “Resources from ground”, etc.). If required for the applied LCIA method (see chapter 6.7.5), differentiated compartments may be used.
- II) **SHOULD - Product and waste flows and processes:** The naming and classification of product and waste flows as well as processes should apply the recommended nomenclature and they should be measured in the flow properties and units given in the guidance on “Nomenclature and other conventions”. [ISO+]
- III) **SHALL - Flow properties and unit groups:** The assignment and naming of new flow

<sup>161</sup> The guidance foresees also, specifically for chemical substances (both inputs and emissions) the identification through CAS No. to avoid errors.

properties and unit groups shall apply the recommended nomenclature given in the guidance on “Nomenclature and other conventions”. [ISO+]

Note that the need to create new units is a rare exception for LCA practitioners; creating new flow properties will be seldom. For LCIA method developers the need to create new unit groups occurs frequently.

Note that if the above provisions cannot be fully met, this shall be explicitly considered when reporting achieved data quality and when interpreting the results of LCA studies. Note that LCI data sets' inventories that do not meet the above requirements are not compliant with the ILCD nomenclature.

## 7.5 Developing generic LCI data

### Overview

In LCA, specific, average and generic data sets are often differentiated. In practice typically a combination is found. The "pure" concepts are nevertheless explained here, as they imply relevant differences in data collection, modelling, documentation, and review.

### Terms and concepts: Specific, average and generic data sets

#### Specific data

A specific data set in its pure form represents a single process (e.g. a specific technology as operated on a given site) or system (e.g. a specific product model of a single brand) . It exclusively contains data that has been measured at the represented process. For data sets on whole systems that would mean that all data for all processes has actually been measured.

#### Average data

An average data set ideally combines different specific data sets and/or other average data in an averaging way to represent a combination of processes (e.g. different waste incineration technologies) or systems (e.g. a products group). The averaging can - among others - go across technologies, products, sites, countries, and/or time.

#### Generic data

A generic data set has been developed using at least partly other information than those measured for the specific process. This other information can be stoichiometric or other calculation models, patents and other plans for processes or products, expert judgement etc. Generic processes can aim at representing a specific process or system or an average situation. Both specifically measured data and generic data can hence be used for the same purpose of representing specific or average processes or systems.

A generic data set represents a typical variant of the process or system, an average data set represents the average situation for the process or system, in both cases within a specified geographic region and time. The difference lies in how the data set is modelled: in the first case the product and its life cycle is specified with typical (or representative) characteristics and the inventory is modelled accordingly. In the second case several products (or technologies or production plants) are separately modelled and the inventories are subsequently averaged.

### Collecting data for generic data sets

For generic data sets, plan the data collection and system model based on knowledge about the typical or representative/average characteristics of the process or product. Typical characteristics are: the technology routes and raw material bases which are used, emission

abatement technologies and emission limits to be met, operation parameters, material composition, etc. Note that an averaging of process or product characteristics is not always useful (e.g. in case of averaging of two very different technologies that produce the same material) or may result in allocation problems (if one of the averaged processes is multifunctional). In those cases a combination of generic modelling and averaging should be foreseen.

The generic data set can also reach a high quality IF the information and data for the typical characteristics of the system or technologies are available. The effort for modelling generic data sets is clearly smaller, but it has limited applications, basically its use as background data set, and – if high quality could be achieved – as benchmark.

Specific data has the clear advantage of representativeness compared to generic data. In practice specific data is however not always the most appropriate source for a required data set. This is e.g. if the available specific data has lower quality than generic data. Generally the aim should be to first look for available specific data or measure it and then go for generic approaches.

## 7.6 Selecting secondary LCI data sets

(Refers to aspects of ISO 14044:2006 chapters 4.2.3.3.2)

### Overview

Secondary data refers to data that is not based on measurements of the respective process(es) in the foreground system. I.e. if data for a missing foreground process is derived from patents this is secondary data, even if done by the process operator. Also all data that is obtained for use in background system is secondary data, even if provided by the suppliers<sup>162</sup>.

For the background system, data from secondary data providers (especially generic or average process data sets) are provided in LCI databases of national or regional LCA projects, consultancies and research groups. One way to identify suitable data sets is the upcoming ILCD Data Network that allows all data providers to distribute their data sets, upon own conditions – as long as the data meets the minimum requirements of the ILCD Handbook or other, entry-level requirements that might be set.

### **Frequent errors: Insufficient methodological consistency of background data**

When selecting secondary data sets, it is important to ensure that all data sets used in the modelling of the system model are methodologically consistent. The use of inconsistent data can unfortunately often be observed in practice. This is done due to a lack of awareness of the problem, or ignoring it to save efforts or costs. However, the use of inconsistent data from different data systems makes the whole LCI/LCA study unreliable and distorted, often with wrong conclusion and recommendations drawn. The analysis of methodological consistency is hence one key issue to be covered by an independent external review process.

The selection of secondary data (e.g. generic and average data for background use) has to consider their appropriateness and consistency in terms of methodology and regarding the data quality of the inventories, i.e. their representativeness, completeness, and precision. This is indispensable to ensure that together with the primary data they achieve the required completeness and precision of the system's LCI. An appropriate documentation of these data

---

<sup>162</sup> Note that the term secondary data provider usually refers to all other sources than the producing or service providing businesses and their trade associations. That can be e.g. consultants or research groups.

sets, e.g. in the ILCD data format that has been developed for this purpose, substantially supports their correct selection and use, as well as supports interpretation of results.

### Pre-verified data

The use of already independently reviewed generic background data sets (but also average data e.g. from trade associations) is recommended as it has two advantages: it gives an independent guarantee about the claimed quality of the data set. In addition, it considerably lowers the review effort, as the data set has already been reviewed and when using the data set only the appropriateness of the selected process for the analysed system is to be judged.

## Provisions: 7.6 Selecting secondary LCI data sets

Note that these provisions also apply to the development of unit process and partly terminated system data sets as deliverables, as the cut-off rules need to be evaluated from the system's perspective.

Attributional and consequential modelling and the Situations A, B and C need at least partially differently modelled data sets.

- I) **SHALL - Use consistent secondary data sets:** The secondary data (generic, average or specific data sets) to be used in the system model shall be methodologically sufficiently consistent among each other and with the primary data sets that were specifically collected.
- II) **SHOULD - Quality-oriented selection of secondary data sets:** Secondary data sets should be selected according to their data quality in a stricter sense, i.e. their technological, geographical and time-related representativeness, completeness and precision. Their reference flow(s) and/or functional unit(s) should moreover be sufficiently representative for the specific processes, good or service that they are meant to represent in the analysed system.
- III) **MAY - Prefer pre-verified data sets:** It is recommended to give preference to already critically reviewed data sets ("pre-verified data") as this limits the effort for an review of the analysed system: only the appropriate use of these data sets in the analysed system needs to be reviewed. [ISO+]
- IV) **MAY - Prefer well-documented data sets:** It is recommended to give preference to data sets that are supported by a comprehensive and efficiently organised documentation. This allows the modeller (and later a reviewer) to judge the data set's quality and its appropriateness for the analysed system. [ISO+]

The combined use of data from different sources is facilitated by using either single operation unit process data set background systems that can be adjusted / re-modelled by the user to be consistent with the analysed system, or by using LCI results data sets that are consistent with the methodology applied in the analysed system.

## 7.7 Averaging LCI data

### Overview

Figure 22 illustrates the main different forms of processes averaging (also named horizontal averaging) and systems averaging (also named vertical averaging): In process averaging, two or more processes that provide the same functions but represent different e.g. technologies, sites, years, etc. are averaged. This typically includes a weighing a non-

even of the inventories according to their contribution to the to-be-represented average situation. E.g. may the steel industry develop a global sector-average Blast Oven Furnace (BOF) process data set, by inventorying the BOF processes one by one at the individual sites and summing up the inventories, weighted / scaled by the relative contribution of each site to the total BOF steel output. In such averaging any missing data is typically filled with data from similar e.g. sites, to ensure that the e.g. technology and country mix represents well the aimed at average.

Systems' averaging analogously averages the cradle-to-gate or cradle-to-grave inventories of two or more systems. E.g. expanding on the above example, could the cradle-to-gate inventories of BOF steel of the various sites be summed up and averaged in a weighted way. This would include the background system of the BOF process, i.e. resulting in global average BOF steel as a product ("system").

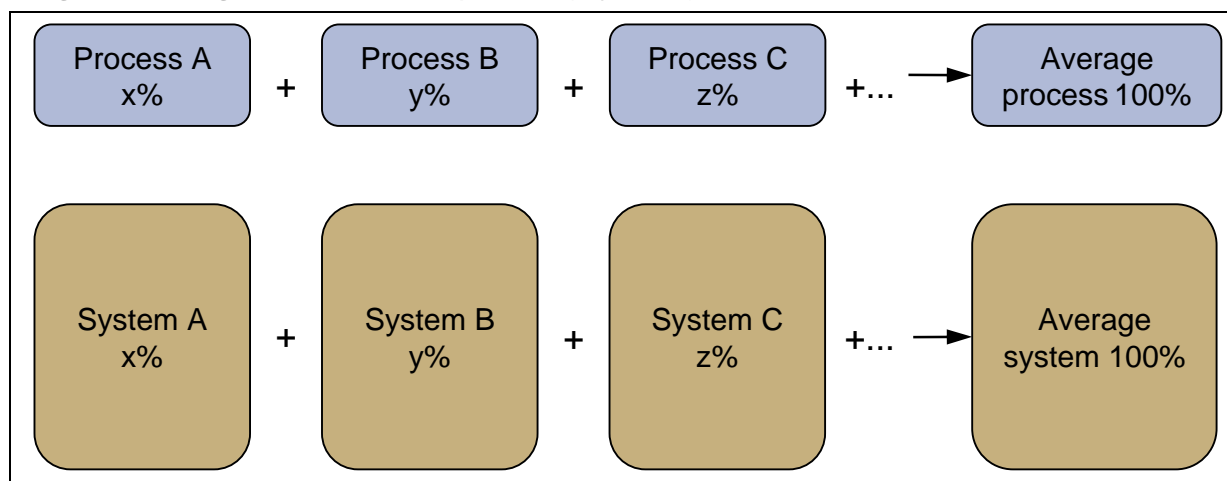

**Figure 22 Processes averaging ("horizontal averaging", top) and systems averaging ("vertical averaging", bottom); schematic.**

As initially mentioned, in practice often a combination of both specific and generic approaches will be found, as e.g. different production routes with different raw material bases cannot usefully be integrated into one "typical" process (or even full life cycle), so that the main variants are modelled as generic data sets and the inventories are subsequently averaged.

A specific and often used type of average data sets are production, supply and especially consumption mix data sets; the latter is the most commonly required one in LCA. Figure 23 illustrates the concepts:

- The production mix of a given product of Country A is the average of the inventories of the different technologies/routes that produce that product, weighted by output in that time period as operated in the territory of country A. The weights that should be used in LCA are the physical units of the product (e.g. mass, volume, pieces), not the production or market value.
- The consumption mix is the inventory of the production mix plus the inventories of the imported products minus the inventory of the exported products. The composition and the amounts of the imports from the different countries is to be considered when averaging the data to the weighed consumption mix. Note that other than exemplified in the figure, the export mix of a country often differs from its production mix and also among the target countries; it is to be analysed whether the differences are relevant for the analysed system and question. The same applies analogously of course for the import mix.

- The supply mix is then the production mix plus the import mix, i.e. the mix of what is available in the country for consumption.

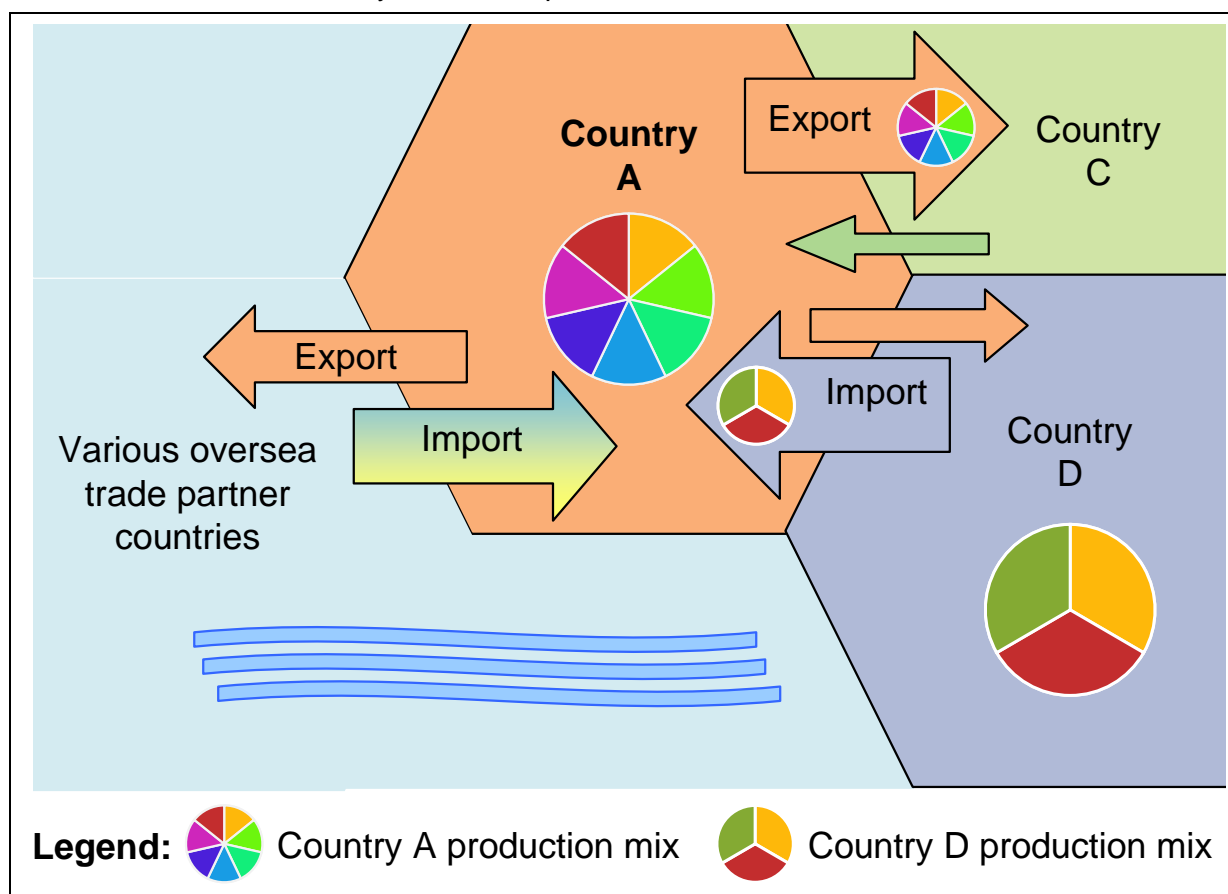

**Figure 23** Illustration of the trade-relations between countries, as basis for calculating the production, consumption and supply mixes of products.

Note that when calculating the mix of services of a country, care needs to be taken to avoid double-counting as imported services may be physically performed in the countries territory (e.g. on-site consulting services), while others are performed in the foreign country (e.g. tourism services to citizen of the analysed country). I.e. other than for goods, where the physical flow of the good goes from the source to the sink, for services the physical flow of e.g. staff performing the services in another country or tourists receiving the service in a another country makes this less clear. In general and for both goods and services, the direction of a product is opposite to the direction of the money flow. This helps identifying and calculating such trade-mixes.

### Collecting data for average LCI data sets

When basing average data sets on the combination of producer specific data sets, plan the data collection to be based on information on e.g. the relative contribution of the individual producer or a certain production route to the overall production (see earlier examples on the average BOF process and BOF steel product data sets). This is necessary to be able to calculate a representatively weighted average data set. In the frequent case, that data is not available for all production sites or service operators, other additional information is required, especially for which share of the market the available inventory data and the specific technologies, countries etc. is representative.

The average data set is hence often more representative of the process or system than the generic data set. This is valid provided that sufficiently representative data is available for

all relevant product variants, sites, etc. and can be accompanied by statistical information of how much data varies between the underlying products or sites. The effort for data collection is clearly higher for average data sets than for generic data sets, but this approach offers in return other advantages such as the possibility of internal benchmarking, weak point / improvement analysis, generation of producer-specific EPDs etc., i.e. the intended applications largely determine which variant is preferable.

## 7.8 Modelling the system

(Refers to aspects of ISO 14044:2006 chapter 4.3.2)

### Introduction and overview

The system is to be modelled applying the LCI modelling framework that was identified in chapter 6.5.4 as part of the scope definition and in accordance with the goal of the LCI/LCA study.

This has two interrelated aspects: how to actually model the system along the used LCI modelling framework. This is addressed in this chapter. Regarding overarching methodological issues see chapters 7.4.3 and 7.4.4.

As the second and more complicated issue, multifunctionality of processes has to be solved, i.e. allocation criteria are to be identified and applied (for attributional modelling) or superseded processes to be used in case of substitution are to be identified (in case of consequential modelling).

The issue of solving multifunctionality for attributional modelling is given in the next subchapter.

The guidance on identifying superseded processes for consequential modelling has already been addressed in chapter 7.2.4.6, as it belongs to that earlier step of identifying processes within the system boundaries.

### Filling initial data gaps

For a cradle-to-gate or cradle-to-grave system, in principle the same interim quality control criteria apply as for the unit process (see chapters 7.4.2.11 and 9.3.2 for the systematic approach). It additionally plays a role which amount of the specific unit processes is required in context of the whole product system: for those parts of the product system that contribute little to the final results (i.e. to the overall environmental impacts of the product), the cut-off criteria can be less strict, while still achieving the overall requirements to completeness and precision. E.g. if a laptop is analysed over its life cycle, the PVC used for insulation of the internal wiring may contribute little and "data estimate" quality data may be sufficient. Whereas the electricity consumption in the use stage might be found to contribute e.g. to 50 % or more to the overall environmental impact and its production must hence be included with high quality data to achieve a high accuracy and precision for the whole data set.

For filling data gaps, estimate data sets may be considered to be used. Such may be e.g.:

- generic or average data for missing specific data,
- average data of a group of similar products for missing inventory data for other, not yet analysed products of that group,
- correlation with other, more complete and high quality data for the same or similar process but from other data sources (e.g. industry average data for improving a producer-specific process),
- justified judgements of technical experts / process operators.

Relevant data gaps generally shall be filled with methodologically consistent data. Gaps of low relevance may also be filled with methodologically not fully but sufficiently consistent data sets, while being developed along the guidance of this document and meeting the overall quality requirements.

Only data estimates that increase the overall quality of the final inventory of the analysed system shall be used to fill data gaps. That means that the individual data sets quality level shall be at least equivalent to a "Data estimate" (see annex).

### Scaling all processes of the system

Modelling the system means to correctly scale the inventories of all processes that are included in the system boundaries of the analysed system. In practice that means to ensure that all product and waste flows that connect the foreground system with the background system are "saturated" with the appropriate background processes<sup>163</sup>. If the inventories of all required processes have been collected or compiled from data providers, this step is rather straightforward. Two main approaches exist in the widely used LCA software tools:

- In the "process-flow" approach the modelling is done by manually or semi-automatically connecting processes via their input and output product and waste flows.
- In the "matrix"-approach this connection is done automatically, provided all to-be-connected product and waste flows on the output and input side of all processes are identically named.

In practice very often not exactly the required process data set is available, but data sets of similar products (e.g. "Carbon steel billet 9SMn28" instead of "Carbon steel billet 9SMn36") or similar regions ("NL – Ammonia; technical, liquid" instead of "BE – Ammonia; technical, liquid") are to be used. In "matrix" tools such cases need additional mechanisms and/or manual renaming or duplicating of processes as workaround to ensure a correct modelling. In "process-chain" tools such processes need manual connection of these product or waste flows. For details refer to your LCA software manual.

### Additional quality control

While formally a step done when collecting data or compiling data from background databases of data providers, in practice the modelling of the system is the moment when the LCI modeller is again to check the appropriateness of the used background processes. This is done along the data set documentation, especially regarding the data sets' technological, geographical and temporal representativeness as well as methodological appropriateness and consistency. The overall completeness and accuracy of the system model results is checked later along the calculated LCI results (see chapter 7.10) and controlled in view of the system boundaries as defined in chapter 6.6, leaving no quantitatively relevant un-connected product and waste flows in the inventory.

### Parameter settings

Whenever parameterised processes are used (e.g. for transport, waste management, but also for mixer-processes that mix different processes to represent a market mix or technology mix), the case-specific correct parameter values have to be set for all these processes.

---

<sup>163</sup> This applies independently whether working for the background system with LCI results or with unit processes, as in practice the practitioner will embed the specific foreground system of the analysed product system into a background system (database).



## Provisions: 7.8 Modelling the system

Applicable to Situation A, B, and C, differentiated.

Differentiated for attributional and consequential modelling.

Applies also to the development of unit process and partly terminated system data sets as deliverables, but only to quantify the achieved completeness and precision, as they need to be evaluated from the system's perspective.

- I) **SHALL - Scale inventories correctly:** The inventories of all processes within the system boundary shall be correctly scaled to each other and to the functional unit(s) and/or reference flow(s) of the analysed system<sup>164</sup>.
- II) **SHALL - Complete system model:** No quantitatively relevant product or waste flows shall be left unmodelled / unconnected, with exception of the reference flow(s) that quantitatively represent(s) the system's functional unit (additional provisions on waste flows see 7.4.4.2). Otherwise these flows shall be clearly documented and the resulting lack of accuracy and completeness be considered in the interpretation of results. [ISO!]

Note that for unit processes all and for partly terminated systems selected inventories of the corresponding products and/or wastes modelling processes are intentionally left out of the system boundary. Their systems are nevertheless completed, while only for applying the cut-off rules.

- III) **SHALL - Set parameter values:** Set the parameter values to the required values in all used parameterised process data sets, if any. [ISO+]
- IV) **MAY - Perform another round of interim quality control:** It is recommended to pre-check during modelling whether the data set or system is properly modelled and meets the quality requirements as identified/fine-tuned in the scope phase; the provisions for interim quality control of unit processes apply analogously (see chapter 7.4.2.11). For filling initial data gaps of included processes and systems estimate data sets may be considered to be used. Such may be e.g.: [ISO+]
  - IV.a) generic or average data sets for missing specific processes / systems,
  - IV.b) average data sets of a group of similar processes or systems (e.g. products) for missing processes / systems for other, not yet analysed processes or systems of that group,
  - IV.c) correlation with other, more complete and high quality process data sets for the same or similar process but from other data sources (e.g. industry average data for improving a producer-specific process).
- V) **SHALL - Use consistent data to fill data gaps:** Data gaps shall be filled methodologically consistent data sets, while gaps of low relevance may also be filled with methodologically not fully but sufficiently consistent data sets while being developed along the guidance of this document and meeting the overall quality requirements as detailed below. [ISO!]
- VI) **SHALL - Use sufficiently quality LCI data sets to fill gaps:** Only data and data sets

<sup>164</sup> This can be visualised by having all processes connected with each other via their reference flows of interim products and wastes, in the correct amounts. Starting from central process and the amount(s) of the system's functional unit(s) or reference flow(s), all other processes are stepwise, relatively scaled. LCA software with graphical modelling interface shows the system in this way and/or the user is modelling the system explicitly by connecting the processes on that interface. Depending on the modelling approach implemented in the software, other mechanisms can be found that serve the same scaling purpose.

that increase the overall quality of the final inventory of the analysed system shall be used to fill data gaps. That means that the individual data or data set's quality shall be equivalent to at least the "Data estimate" quality level. See also chapter 7.4.2.11.3 and annex 12.3. Remaining data gaps shall be reported. [ISO!]

Note that both the approach(es) used to fill initial data gaps and the resulting lack of representativeness, precision and methodological consistency of the whole data set is later to be clearly documented and explicitly considered when declaring the achieved data set quality or when drawing conclusions or recommendations from an LCA study.

Note that the final check on the achieved overall environmental completeness / cut-off is detailed in chapter 9.3.2.

Note that decisions on any omissions of life cycle stages, types of activities, individual processes or elementary flows must be clearly reported and should be justified by the fact that they do not contribute significantly to the LCI results in view of the intended application(s) of the outcome of the LCI/LCA study. Otherwise they need to be reported and considered when declaring the achieved data set quality and/ drawing conclusions and recommendations from the study.

## 7.9 Solving multifunctionality of processes in attributional modelling

(Refers to ISO 14044:2006 chapter 4.3.4)

### 7.9.1 Introduction and overview

(Refers to aspects of ISO 14044:2006 chapter 4.3.4.1)

#### The problem of multifunctionality

(For an overview of multifunctionality and the different approaches of how to solve it see also chapter 6.5.3.)

Many processes contribute to the provision of more than one function by yielding more than one product (co-products, i.e. co-goods and co-services) or by servicing more than one input (e.g. waste treatment of mixed waste flows), or combinations thereof.

The problem about such multifunctional processes is that in LCA we need to analyse a single system in order to determine the specific environmental impact which can be related to its life cycle. In the real world there is however hardly any system which exists in isolation. As soon as a co-product arises in a process that is part of the system being analyzed, it is used typically in a different system. This means that the process becomes part of another system as well<sup>165</sup>, and that its environmental impacts can no longer be fully ascribed to the system that we study.

An apparently different but methodologically fully analogous situation of shared impacts is associated with the recycling of end-of-life of products and of waste occurring during production or use: a material may be recycled, energy be recovered, or part be reused from one system and used again in one or more other systems. This means that the provision of secondary resources or parts is another function of the system that generates the waste or end-of-life product: The impacts associated with the secondary goods<sup>166</sup> are to be shared among the systems that use them.

<sup>165</sup> This is also referred to as „shared processes“.

<sup>166</sup> The term „secondary good“ is here used as umbrella term for recycled materials, recovered energy, reused or further used parts, etc., i.e. for any (secondary) function that is produced from a waste of end-of-life product.

Note that the following chapter provides guidance on solving multifunctionality in attributional modelling only, as the corresponding task in consequential modelling has been addressed already in the chapter 7.2.4 on identifying and describing processes. This was necessary as in consequential modelling this step directly affects the processes to be included in the model, i.e. is not a subsequent step as in attributional modelling.

### **Solving multifunctionality**

Under the (historically developed) heading “Allocation”, ISO 14044:2006 presents a hierarchy of different approaches to this multifunctionality problem<sup>167</sup>. In chapter 6.5.3 the ISO hierarchy and the different LCI method approaches have been detailed and illustrated. At the same time it was found that the approach for solving cases of multifunctionality has to be in line with the goal of the LCI/LCA study, especially the decision-context(s), as consistency with the goal is a guiding principle of ISO-LCA. This means that there is no free choice between allocation and substitution, but the goal of the LCI/LCA study defines which approach is theoretically appropriate: The way of how to handle multifunctional processes is closely related to the applied LCI modelling framework, being consequential or attributional (see chapter 6.5.2) and it had to be made in accordance with this choice.

The present chapter relates to attributional modelling, i.e. for Situation C2 and for those cases where substitution is not possible or feasible; see the respective provisions for the other Situations. This means that the first step is the subdivision of multifunctional black box unit processes to mono-functional single operation unit processes and thereby cutting free the actually required production processes, avoiding the need for allocation. If this is principally impossible or other reasons make it practically impossible, allocation (partitioning) is the next possible step (see chapter 6.5.3).

## **7.9.2 Avoiding allocation by subdivision of virtual subdivision**

(Refers to aspects of ISO 14044:2006 chapter 4.3.4.2)

Multifunctionality can occur on two levels: single operation unit processes that principally cannot be further sub-divided for data collection purposes (e.g. the electrolysis process of NaCl electrolysis, yielding NaOH solution, Cl<sub>2</sub> and H<sub>2</sub> as co-products) and black box unit processes that can be further sub-divided (e.g. a manufacturing line with several kinds of polymer packaging produced as co-products).

In the first example, allocation is the appropriate approach under attributional modelling to solve the multifunctionality.

In the second example, first choice is to subdivide the concerned "packaging manufacturing" process into its included specific processes for the different packagings, if it is possible in this way to separate the production of the analysed good or service from that of the co-function(s); see Figure 8. Chapter 7.4.2.2 provides the detailed guidance for subdivision.

In the case subdivision is not feasible due to lack of access to data or resource-restrictions, virtual subdivision can in many cases fully or partly single out those inventory items that exclusively relate to the required function. This renders the inventory more accurate, as only the possible remaining inventory items are to be allocated; it also improves the reviewability of the data. Chapter 7.4.2.2 provides some more details also on virtual subdivision.

---

<sup>167</sup> As the hierarchy covers other approaches than only allocation, clearer and more appropriate would hence be the encompassing title „Solving multifunctionality of processes“.

### Provisions: 7.9.2 Avoiding allocation by subdivision or virtual subdivision

Applicable to Situation C2. Applicable to cases of Situation A, B, C1 only if subdivision, virtual subdivision and substitution/system expansion were not possible or feasible, as identified along the specific provisions for these Situations (see 6.5.4).

Applicable only to attributional modelling, unless in consequential modelling substitution is not possible or feasible.

- I) **SHALL - Analyse whether allocation can theoretically be avoided by subdivision:** Investigate whether the analysed unit process is a black box unit process (concept see Figure 7): does it contain other physically distinguishable sub-process steps and is it theoretically possible to collect data exclusively for those sub-processes? Next, check whether subdivision can solve the multifunctionality of this black box unit process: can a process or process-chain within the initial black box unit process be identified and modelled separately that provide only the one required functional output?
- II) **SHALL - Aim at avoiding allocation by subdivision or virtual subdivision:** Based on the outcome, the following steps shall be followed:
  - II.a) **Subdivision:** If it is possible to collect data exclusively for those included processes that have only the one, required functional output: inventory data should be collected only for those included unit processes.
  - II.b) **Partial subdivision:** If this is not possible (i.e. the analysed unit process contains multifunctional single operation unit processes that are attributed to the required functional output) or not feasible (e.g. for lack of access or cost reasons): inventory data should be collected separately for at least some of the included unit processes, especially for those that are main contributors to the inventory and that cannot otherwise (e.g. by virtual subdivision - see later provision) clearly be assigned to only one of the co-functions. [ISO+]
  - II.c) **Virtual subdivision:** It should be checked whether it is possible by reasoning to virtually partly or fully sub-divide the multifunctional process based on process/technology understanding. This is the case wherever a quantitative relationship can be identified and specified that exactly relates the types and amounts of a flow with at least one of the co-functions / reference flow(s) (e.g. the specific mechanical parts or auxiliary materials in a manufacturing plant that are only used for the analysed product can be clearly assigned to that product by subdividing the collected data). For those processes where this can be done, a virtual subdivision should be done, separating included processes as own unit processes. Chapter 7.4.2.2 provides additional details on the approach. [ISO+]
  - II.d) **Justify need for allocation and document potential distortion:** If the preceding sub-steps are not possible and a real or virtual separation is not feasible, allocation is the approach that shall be applied (see next chapter). In addition and only if subdivision is theoretically possible but was not performed, it should be demonstrated/argued at least via quantitative approximation or reasoning that the decision for allocation does not lead to relevant differences in the resulting inventory, compared to a subdivision. If it leads to relevant differences, the respective cases shall be documented and shall later be explicitly considered when assessing the achieved accuracy of data sets and when interpreting the final results of LCA studies, respectively. [ISO!]

Note that virtual subdivision can also improve the basis for allocation, with more accurate results.

## 7.9.3 Solving multifunctionality by allocation

(Refers to ISO 14044:2006 chapter 4.3.4)

### 7.9.3.1 Overview

(Refers to aspects of ISO 14044:2006 chapter 4.3.4.1)

Allocation criteria are to be identified for those cases where allocation (and not substitution) is required to be applied to solve multifunctionality of not further subdividable unit processes<sup>168</sup>.

The allocation criteria are identified in a two-step procedure, starting with and strongly building on the physical causality, as equally recommended in ISO 14044:2006.

To summarise this two-step procedure that is detailed in the following subchapters:

- As first criterion other “determining physical causal relationships” between each non-functional flow and the co-functions of the process are to be identified and applied<sup>169</sup>. Part of this is to use the virtual subdivision approach to assign flows to the co-functions, as much as possible.
- Flows that cannot be allocated in this way are to be allocated using a second, general allocation criterion, which is the market value of the co-functions in the specific condition and at the point they leave the process (or enter it as e.g. in case of waste and end-of-life treatment services).

While some of the rules and examples for the first criterion are obvious, this is not always the case. Some effort is therefore made here to clearly specify and illustrate this procedure to ensure reproducibility in practice, starting with simple and obvious cases.

A special issue is the waste and end-of-life product recycling that requires additional steps, why it is addressed in a separate annex 14.

### 7.9.3.2 First criterion “Determining physical causality”

(Refers to aspects of ISO 14044:2006 chapter 4.3.4.2)

#### Determining physical causality

The determining physical causality can relate to both goods and services. This expression is composed of three components: causality, physical, and determining:

- “Causality” relates to the question whether the existence and quantity of a non-functional flow is caused by the respective co-function.
- “Physical causality” means that this cause is to be a physically determinable one including an extensive physical flow property (e.g. especially the energy content (enthalpy, lower and upper calorific value, exergy, entropy), mass, volume, length/distance, specific element/substance/material/part content, number of pieces (number of items, individuals, particles/moles)). In the case of services, the physical property is typically to be used in combination with time/duration of the service, as

<sup>168</sup> Note however, that allocation may also need to be applied in cases where at first sight and from a limited, theoretical decision-consequence perspective system expansion / substitution would be the correct approach.

<sup>169</sup> The need is seen to develop supplementing practice-manuals for main product groups, to further enhance practicability and reproducibility. This could follow the same general logic as applied when developing Product Category Rules (PCR) in support of Environmental Product Declaration (EPD).

this is its mostly applicable reference unit. I.e. two or more properties together are causally determining.

- “Determining”, finally, relates to the fact that often several causal physical relationships exist of which only one or a combination of two is determining the existence and quantity of a non-functional flow.

The determining physical causality is identified by answering the question “Is there a specific function that the non-functional flow performs for one or more of the co-products and can I quantify the extent of this function via a physical criterion?”. And: “If so, are there other non-functional flows that occur quantitatively or partly as direct or indirect consequence of the initially identified, physically caused non-functional flow?”

It is important to note that other than found often in practice, there is no need to apply the same physical causality criterion to all non-functional flows. In contrast is this rather seldomly correct: the physical causality is often specific for a flow, same as the underlying reality is specific. This applies to black box unit processes, where specific processes with specific inventory items relate to the analysed function. Note that this also applies to multifunctional single operation unit processes where specific input products (e.g. a chemical such as Chlorine), entirely end up only in one of the co-products (e.g. the chlorinated chemical as one of the co-products). That means that often a combined, multiple allocation of the different non-functional flows of the inventory is necessary.

### **Principle of applying the virtual subdivision logic within the physical causality**

The logic of virtual subdivision is closely related to the one of determining physical causality: Both aim at identifying which amount of which inventory items are exactly related to which co-product, reflecting the physical relationships among them. E.g. all input products that are physically embodied in any of the co-produced goods<sup>170</sup>, can be directly assigned to them. This was illustrated in the chapters 7.9.2 and 7.4.2.2 on virtual subdivision with the example of different parts that enter a manufacturing line of trucks and each end up only in the specific trucks that use this specific part.

### **Embodied goods (product flows)**

An obvious example for the embodiment of goods are components that are assembled to more complex goods, e.g. the specific components that enter a multiple production line of tailor-made trucks and end up in a specific truck are assigned to the truck they are build into. In this example the process is partly virtually sub-divided along a qualitative understanding, assigning the individual input product flows to the receiving co-product. Note that this step is equivalent to the earlier addressed virtual subdivision of unit processes along a qualitative technical understanding of that process. This can even be applied in cases of physically not further sub-dividable single operation unit processes.

A similar example is an injection-moulding machine that processes different polymers and where each specific polymer input flow is assigned to that specific moulded part that is made of it (see also chapter 7.4.2.2 on subdivision and virtual subdivision).

In other cases the same material that directly enter a process can be physically found in several co-produced goods. E.g. the round wood that is entering a sawmill, is equally found in the co-produced beams, planks, slabs, wood chips, and sawdust. The amount of round-

---

<sup>170</sup> Physical embodiment can obviously not relate to services.

wood product flow that is embodied in the respective co-product is assigned to its inventory<sup>171</sup>.

### Components of the determining physical causality

The next step is the determining physical causality in a wider sense.

Care must be taken to identify exclusively the causal and not other, non-causal physical relationships (and subsequently identify which is the determining one): In mining of e.g. granite as functional material, granite tiles are produced together with granite gravel as valuable co-product. The mining itself and transport of the raw blocks to the plant would need to be allocated by mass to both co-products, as physically required for their production. The cutting of the blocks into the tiles and remaining gravel as cuttings is equally physically required for both co-products. The cutting process is however determining only for the co-product tiles, as it relates to its specific characteristics of smoothly cut surfaces, while not to the granite gravel.

A similar example is a gold-ore extraction process where the applied mining chemicals are physically mixed with the whole ore, but are determining only for the extracted gold (and other metals that are extracted by that chemical) but not to the rocks that come out of the process, even though they may be valuable co-products with use in road construction. The preceding gold-ore mining and grinding processes again would be physically required for both co-products, same as in the above granite example<sup>172</sup>. Key for correctly identifying the determining physical causality is the understanding of the causalities that links each of the co-products with the respective other non-functional flow that needs to be allocated.

The following paragraphs show how this determining physical causality is identified for different types of non-functional flows and for both co-produced goods and co-services. Illustrative examples serve to clarify and further guide their application:

#### Allocation of good's inputs to co-services:

For co-services, the use of any product, component, consumable material etc. input that is used exclusively to provide the respective co-service's function is obviously a determining physical relationship.

Note that this step is identical to the earlier described process of a virtual subdivision of a unit process along a qualitative understanding of that process: in an example a retailing shop may selling among other goods frozen food. The production and operation of the freezer would then be allocated exclusively to the goods that are sold via display in the freezer. (Regarding the question how to allocate the freezer among the various goods sold from the freezer see more below).

#### Allocation of good's inputs to co-produced goods:

For co-products, in many cases the used input products, energy carriers, etc. can equally often largely be allocated based on the specific function they perform in relation to the individual co-products. For example, electricity used in the chlor-alkali-electrolysis is used to split the water and results in production of the energy-rich hydrogen and chlorine gases as

---

<sup>171</sup> Note that other than it may appear, this is NOT equivalent to allocation by mass, as loss of material to non-valued outputs is not yet addressed and would need to be allocated in a subsequent step.

<sup>172</sup> One could argue that the high effort for deep underground mining of gold-ore is not really necessary to obtain some low-value gravel as co-product. However, this consideration is a consequential one and looking as costs as a cause. Attributionally, it is necessary (physical causality) to get the ore from that depth to produce that specific gravel.

co-products. The enthalpy of H<sub>2</sub> and Cl<sub>2</sub> is hence an appropriate allocation criteria for the used electricity, reflecting the determining physical relationship of bringing energy into the co-products. In the similar example of the Haber-Bosch-Synthesis of ammonia, natural gas is the energy source to capture nitrogen from air to produce the ammonia. CO<sub>2</sub> is the co-product (if captured, e.g. for a subsequent step of urea production, and not vented). The energy of the natural gas is exclusively found in the ammonia (apart from energy-losses due to process inefficiency), while not at all in the CO<sub>2</sub>. Again enthalpy serves to allocate the inventory of the product natural gas flow to the ammonia co-product .

### **Allocation of service inputs to co-produced goods - introduction:**

The input of many services can be allocated to the co-products by the relative duration they are used in combination with the determining physical causal relationship.

Parallel and serial services can be differentiated:

### **Allocation of service inputs to co-produced goods - parallel services:**

Parallel services serve at the same time in parallel several co-products and that relate to the co-products in a similar way. Examples are the services that storage facilities, transport equipment, manufacturing halls, and production equipment provide<sup>173</sup>. E.g. for transport the transport time is one factor (which is equivalent to the transport distance, of course, which is typically used in practice and factually equivalent for co-transport). In addition it would need to be checked whether the weight of the co-transported goods or their volume is the limiting physical causality that determines how much of the transport service is used. Duration in combination with either mass or volume is to be used as allocation criterion. Whether mass or volume is determining would be figured out by evaluating whether the given transport case is limited by the mass of the goods (i.e. the truck is fully loaded by mass) or whether more mass could be added, but the truck is full by volume.

Coming back to the example of the freezer used in retail, the time the good is on average stored in the freezer plus the determining physical factor (here we could conclude that this is the volume<sup>174</sup> of the individual good) is used to allocate among the many goods sold via the freezer<sup>175</sup>.

Another example is the service input flows of heating, lighting, and providing a hall structure for several laptop assembly lines: the duration of assembly of the different co-produced laptops would be the allocation criterion for the three named inputs. Among the possible physical criteria (mass, volume, pieces), the piece of laptop could be singled out as

---

<sup>173</sup> It is argued to be clearer to understand such products from the perspective of the service they provide, e.g. the service of providing a hall structure, heating and lighting for an assembly line, rather than as a good. Other than a material or part that is physically ending up in the product, all these buildings etc. only provide a service for the co-production. For this reason they also typically need other allocation criteria (e.g. duration of use of a storage hall, lighting, etc.) compared to the element, mass or energy content as allocation criteria of goods that physically end up in the co-products. In fact are many such infrastructures also operated under leasing contracts („product-service systems“).

<sup>174</sup> While the heat capacity of the good also plays a role, it might be found that the main energy consumption is for compensating the loss through the surface of the freezer including its opening on top or door by the customer. Let aside a few more complex considerations of the shape of the good/package, i.e. how well it fills the freezer, and how cold it arrives at the freezer, the volume might still be the most appropriate criterion in most cases.

<sup>175</sup> Note that the precision with which such storage times and volumes must be determined, depends on the relevance of the freezer storage for the whole product system analysed. In the iterative approach to LCA and after an initial, rough approximation of such numbers, it is identified how relevant this process is and only if relevant the storage time and volumes need to be identified in more detail.



limiting, if we assume that the specific mass or volume do not determine the size of the hall, lighting etc.

Another example on services: the inventory of operating a law firm, providing legal services for different customers would be allocated by the duration with which the customer-assistances use the law firm. Regarding the physical criterion (imaginable: mass, volume, pieces) we would probably agree on the pieces (i.e. number) of customers and not their mass or volume.

A final example on transport services: In the case of allocating passenger-transport by plane it gets more tricky, as both mass and number of passengers are in fact limiting (due to maximum take-off weight and the number of available passenger seats; any remaining weight would be available for additional freight transport). However, in the average situation neither seats nor the available total weight are used to capacity. Hence we need to allocate between the number of passengers and the weight of the freight in any case. How this? The plane's fuel consumption and related emissions (looking only at that part of the inventory) is determined - for a given route - by the plane's aerodynamics (which is determined largely by its outer size and shape) and additionally by the total starting weight. Any additional passenger will only affect the starting weight, same as any additional kg of freight. Hence, the determining physical causality is simply the mass. This example also shows the problem of applying economic allocation: in that case a low fare seat would have very little impact compared to a regularly fared seat in the same class, while both have the same contribution to the fuel-related inventory.

If however the parallel service relates to the co-products of the investigated production system in a clearly different way, and the unit process cannot be sub-divided obtaining exclusively non-multifunctional processes, the general allocation criteria is to be applied.

### **Allocation of service inputs to co-produced goods - serial services**

Serial services perform the same action to the co-products one after the other (e.g. a paint shop painting different metal parts one after the other). Strictly, these processes are all sub-dividable, with separate measurements. However, as discussed earlier this may not be easily feasible in practice: If the serial service performs its service in the same intensity over time, it can be allocated simply by the duration it is carried out one after the other for the different co-products. In other cases, a physical characteristic of the serviced co-products can be used (e.g. regarding the paint shop example this would be the surface of metal parts to be painted. In the case of cleaning services, equally the surface of the cleaned floor would be the determining criterion, given same/similar floor types). The intensity of the serial service may change in intensity over time or the serviced co-products have relevantly different characteristics (e.g. cleaning of both carpet and PVC floors). In that case it might be not possible to identify a suitable physical relationship that quantitatively characterises this intensity. In consequence, subdivision would be necessary unless the differences could be demonstrated to be less relevant and the application of the second, general allocation criterion would be possible.

### **Allocation of goods and services inputs to co-produced goods - criteria list**

The following list gives provisions of which criteria should by default be used for allocation in different cases of co-servicing and co-production:

Services:

- Goods transport: time or distance AND mass or volume (or in specific cases: pieces) of the transported good

- Personal transport: time or distance AND weight<sup>176</sup> of passengers
- Staff business travel: added value of system
- Staff commuting: added value of system
- Retailing: time (duration) of shelf-life AND mass or volume of good
- Storage and shelter, i.e. buildings and other **three**-dimensional infrastructure: time (duration) of use AND volume of good OR area occupied by the good
- Storage and other functions provided by places and other **two**-dimensional infrastructure: time (duration) of use AND area occupied by the good<sup>177</sup>
- Transport and communication on roads, railways, pipes, cables, and other **one**-dimensional infrastructure: time (duration) AND intensity (e.g. road wearing impact by vehicles of different weight) OR bandwidth of use.
- Heating/cooling of space (keeping a temperature): time (duration of heating/cooling) AND area or volume heated/cooled (depending whether the space is used by area such as in offices, or by volume such as in staple storage halls or retail freezers)
- Heating/cooling of goods (reaching a target temperature): heat capacity of good
- Private administration services: person time or cost charged for admin services OR market value of sales
- Public administration services: person time or cost charged for admin services OR number of cases serviced
- Cleaning services (of objects of similar cleaning technologies): surface area cleaned (or as fall-back option: time (duration) of cleaning)
- Guarding services: share of product's value among guarded products AND/OR the production/provision facilities' value of the product among guarded site/object, depending what is the purpose of the guarding
- Marketing services: share of product implicitly or explicitly addressed by marketing (e.g. corporate marketing: share of product's value in corporate turnover)
- Teaching/training services: person time (duration) of training AND number of individuals taught/trained
- R&D services (of objects of similar R&D): person time OR cost charged for R&D services

---

<sup>176</sup> If an average passenger is aimed at, this can be expressed also per individual passenger by using an average weight.

<sup>177</sup> Area and duration of actual coverage allocated by assigning to relative contribution if this can be directly determined (e.g. for different processing plants of an integrated chemical site, or for different crops and per-annual trees in an agro-forestry system). If the area is jointly covered (e.g. in mixed cropping, or for co-products from same chemical reactor) this is not possible, and the general allocation criterion is to be applied. Not actually physically covered land that however forms integral part of the analysed process system (e.g. field sides, or unused areas between plants of a chemical site) is equally allocated using the general criterion. Land area that is temporarily not used (e.g. in the time between subsequent crops or between closure and reconstruction of industrial facilities on the same area of land) is generally allocated to the first product system. This also applies to e.g. restoration activities (e.g. fallow-times, site-remediation, etc.); note that these are equivalent also to service inputs into the first product system.

**Production processes:**

- Extraction processes: for process-related flows the market value, for product-related flows the specific physical properties of the co-products
- Chemical conversion and waste processing (including incineration): quantitative change of the to-be-allocated flows in dependency of quantitative changes in the products or functions delivered by the system. If unknown: the chemical or physical properties that determine the amount of the other flows
- Manufacturing (including physical transformation processes) and mechanical waste processing: length, surface, volume, or mass OR number of items OR time of processing
- Recycling, energy-recovery, reuse: see specific provisions in chapter 7.9.3 and details on allocation of waste inputs see annex 14.4.
- General processes by other capital goods' input directly to multifunctional processes (e.g. the processing machines themselves, but not buildings etc.): time (duration) of use OR mass, volume, length of produced good

In the case alternatives are given above, the chosen alternative shall be concisely justified. Exceptions from the above alternatives shall be justified by explaining why none of the provisions is applicable and concisely justifying the one that has been chosen instead, along the guidance given in the text<sup>178</sup>. Equally, if criteria are applied for other than the above listed type of services, there selection shall be concisely justified in analogous logic.

### 7.9.3.3 Second (general) criterion “Economic value” or QFD

(Refers to aspects of ISO 14044:2006 chapter 4.3.4.2)

#### Overview

For flows that cannot be allocated with the first criterion, a second general criterion is to be applied.

#### Allocation of co-functions and comparisons of multifunctional products

For the special case of comparisons of multifunctional products with not sufficiently similar functional units (e.g. printer-fax-photocopier with printer-fax-photocopier-scanner) the Quality Function Deployment (QFD) approach should be considered to allocate parts of the inventory to the not common functions and render the compared products sufficient. QFD helps transforming customer needs ("Voice of customer") into engineering characteristics of a product or service, prioritizing each function (and characteristic that support the function) into development targets for the product or service. For details, see the specific literature. In the context of LCA, QFD can be interpreted as identifying the relevance the different co-functions of a multifunctional product are assumed to have for its average user.

The QFD should be used in preference to allocation by market price, if physical causality cannot solve the multifunctionality. This applies especially to the production stage; for the use stage, the market price as service provision cost might serve (however excluding person / operating time costs, what will often be difficult to determine). Similarly, the market price of

<sup>178</sup> In subsequent work on sector or product group specific guidance documents (e.g. similar as Product Category Rules (PCR) used in Environmental Product Declarations (EPD)) the above rules should be further interpreted and specific guidance provided.

the individual devices might be a suitable criteria for the market price allocation for production and end-of-life stage.

However, if the co-functions have clearly different environmental profiles (e.g. a very different use stage electricity consumption for the heater for the laser print compared to potentially much less for the FAX and scan functions), the QFD alone would lead to distorted results. To overcome such cases, the allocation among the co-functions would need to be more differentiated (or the distortion would need to be reported and reflected in the results interpretation). It might also be necessary to re-evaluate the possibility of virtual subdivision (see chapter 7.9.2).

The foreseen involvement of interested parties and product users would then need to achieve a best attainable consensus on the allocation key as part of the critical review process. Figure 24 illustrates the concept of QFD.

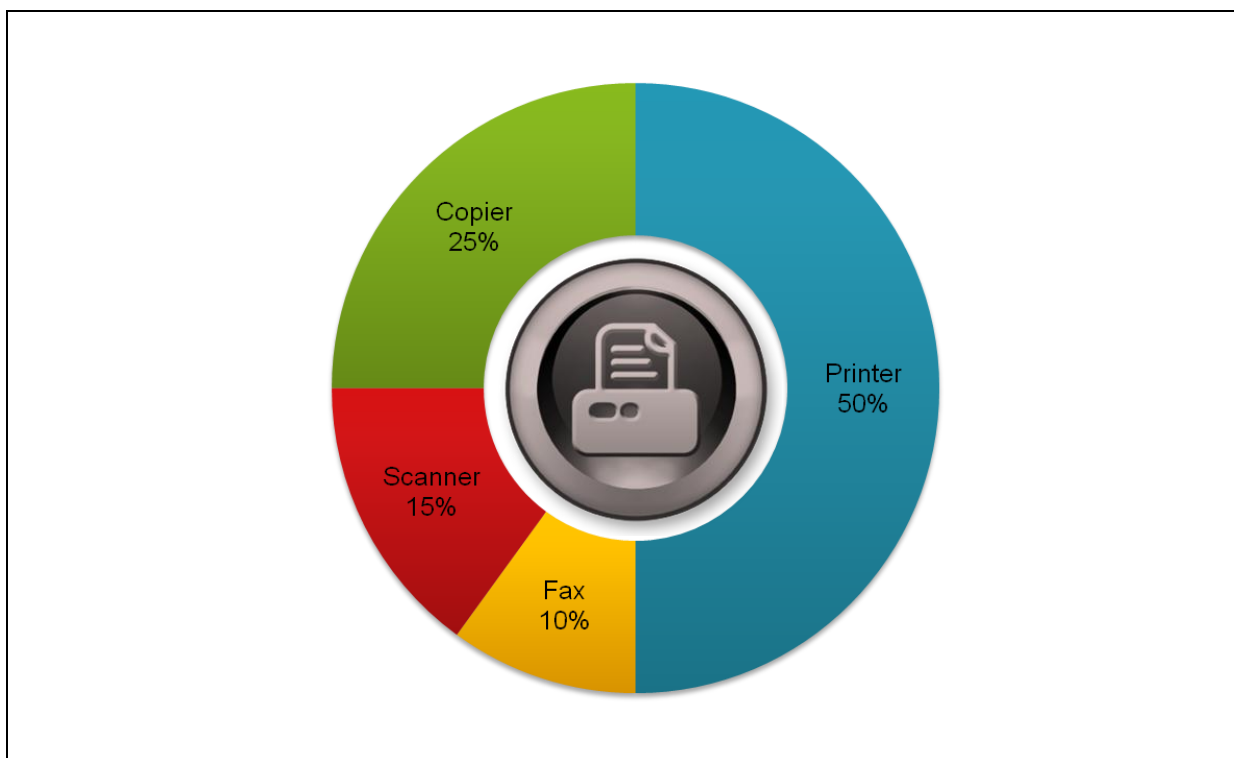

**Figure 24** Quality Function Deployment (QFD) of complex products as an approach for obtaining as allocations factors the relative relevance of functions for the product users.

### Allocation for multifunctional processes

This second criterion is the economic value of the co-products at the point (i.e. at plant / service provider) and in the condition (e.g. not purified / technical quality) and amount (e.g. bulk) as they are provided by the multifunctional process. As economic value the specific market price shall be used. If the co-products are not traded at that point of allocation and with their specific characteristics, the market price has to be derived combining production cost information and the market price of the further processed, packed, transported etc. co-product. Any additional steps of transport, conditioning, packaging etc. are to be considered to make sure the economic value used for allocation actually reflects the value of each co-product at the point and in the condition where it is delivered.

E.g. in case of wheat grain production with straw as a co-product and obtained via a combined harvester, the relevant economic value of the grain and straw is at the field directly

after the combined harvest. As the grain is transported, cleaned, stored, potentially dried and maybe also packed before sold, these additional sets and the related costs are to be subtracted from a large scale/bulk market price. Similarly costs for the baling and transport of the straw are to be excluded from the market price to obtain the relevant economic value at harvest point. Such additional steps can substantially influence the price and distort the allocation, especially for low value/mass goods.

### **Frequent errors: Wrong type/reference of market value**

A frequent error in this type of allocation is to apply the wrong point of allocation. This is most often the case and most easily illustrated for the case of using market price as criterion: in the case of allocating electricity and heat from a combined power plant the most appropriate / correct point of allocation would be inside the plant, with e.g. 3 US-cents per 1 kWh electricity and 1 US-cent per kWh heat. An often found but wrong point of allocation is the reception of the electricity and steam at the final consumer with a price of e.g. 30 US-cents per 1 kWh electricity and 5 US-cents for each kWh heat delivered. As this includes the product-specific heat pipelines and related losses and electricity voltage conversion down to 110 V and loss during delivery to final consumer etc., it distorts the results, in the given example the allocation ratio electricity/heat changes from 3 to 1 to 6 to 1.

### **Examples to illustrate the difficulty to work with physical causality alone**

An example may be wheat cropping with wheat grains and wheat straw being the co-products. The allocation of the used fertiliser and nitrate emissions among these co-products might be based on their specific protein content, reflecting how much of the nitrogen goes into producing either of them. For the tractor's fuel consumption and the occupied land, the allocation criterion is however less clear; the market price or the mass could be considered.

Another example may be the co-transport of goods by truck where the weight of the individual good influences the fuel consumption and emissions of the transport process and where the allocation of the inventory results between the transported goods would be based on the ratio between their weights. Note however that in case the volume of the goods is the limiting factor (e.g. where very light goods such as insulation materials are transported and the trucks capacity by weight is not reached), the situation gets more complex: the good's volume would be the criterion to allocate the inventory of driving the empty truck (i.e. the base inventory), while the goods' mass would be the appropriate allocation criteria for the additional fuel consumption and emissions due to the additional weight of the carried goods.

A municipal waste incinerator treating a mixture of materials in household waste is an example where allocation based on different causal physical relationships between input and output is a useful approach: The emission of cadmium in the flue gas could be allocated between the materials in the co-incinerated waste streams according to their contents of cadmium. The product flow of the recovered heat could be allocated to the co-incinerated waste materials according to their upper calorific value. On the other hand, the causal relationship behind the formation of Nitrogen oxides (NO<sub>x</sub>) in the flue gas is more complex: A part of the NO<sub>x</sub> is process-related formed from oxidation of a small amount of the atmospheric Nitrogen (N<sub>2</sub>) in the incineration air. Another part of this emission stems from the oxidation of the N-content of the waste materials, which calls for the use of another allocation criterion or the combination of more than one. A similar difficulty occurs when allocating dioxin emissions from co-incineration to the different wastes, as both carbon and chlorine sources are needed but also the way the process is operated influences the final concentration, hence there are several potential allocation criteria to be evaluated for appropriateness.

## Outlook: waste fee adjusted market value

It is noted that using the direct market value for allocation is somewhat distorting, as also waste and end-of-life products with a negative market value can have a "value": this is if the value is higher (i.e. the waste fee is less negative) than the default option of e.g. discarding the waste or end-of-life product without benefit, e.g. in landfilling without energy-recovery. Such an adjusted allocation criterion for market price allocation considering the cost-difference to the waste fee cost instead of the direct market value zero, still needs to be developed and practice tested. If so, it might be adopted in sector or product group specific guidance documents or Product Category Rules (PCRs). If these would be developed in an ILCD compliant way (e.g. review, stakeholder involvement) such a different market price allocation can be applied here instead.

## Reuse, recycling, and recovery

For co-production of products from waste that initially has a market value below "0" (e.g. electricity from waste incineration) please see also 14.4.1.3, and for the specific provisions for end-of-life products for reuse/recycling/recovery that have a positive market value please see chapter 14.4.1.2.

### Provisions: 7.9.3 Solving multifunctionality by allocation

These provisions are applicable only for Situation C2 and for those cases in Situation A, B and C, if subdivision, virtual subdivision and substitution/system expansion was not possible or feasible, along the given provisions (see 6.5.4).

- I) **SHALL - Share inventory between co-functions by allocation:** If allocation is to be done, the environmental burden of the concerned processes shall be shared between the co-function(s) of the process or system by allocation. (7.9.3.1)
- II) **SHALL - Differentiate multifunctional processes and multifunctional products:** These two cases shall be differentiated [ISO!]. (7.9.3.2)
- III) **SHALL - Two-step procedure for multifunctional processes:** The following two-step procedure<sup>179</sup> shall be applied [ISO!]: (7.9.3.2)

III.a) **First step and criterion "determining physical causality":** As first criterion, the "determining physical causal relationships" between each non-functional flow and the co-functions of the process shall be identified and used as allocation criterion. This relationship is the one that determines the way in which quantitative changes of the products or functions delivered by the system change the other inputs and outputs. Within this step, process-related inventory flows (e.g. spontaneous NO<sub>x</sub> in incineration, consumption of auxiliary materials) should be differentiated from function (product) related inventory flows (e.g. the NO<sub>x</sub> from the nitrogen in the incinerated fuel, materials or parts ending up at least partly in the co-products).

Note that often a combined, multiple allocation of the different non-functional flows to the co-functions is necessary, applying different criteria for the different flows.

Note also that the preceding step of virtual subdivision is applying the same logic as physical causality

<sup>179</sup> The need is seen to develop supplementing practice-manuals in line with the ILCD and with explicit allocation-criteria/rules for main process and product groups, to further enhance practicability and reproducibility. This could follow the same general logic as applied when developing Product Category Rules (PCR) in support of Environmental Product Declarations (EPD).

### Provisions: 7.9.3 Solving multifunctionality by allocation

allocation.

III.b) **Checklist for "determining physical causality" criteria:** If this is not possible or for any remaining inventory items, the following list gives guidance which criteria should be analysed by default whether they are the "determining physical causal relationship" to be used for allocation in different cases of co-servicing and co-production processes:

#### III.b.i) **Services:**

- Goods transport: time or distance AND mass or volume (or in specific cases: pieces) of the transported good
- Personal transport: time or distance AND weight of passengers
- Staff business travel: added value of system
- Staff commuting: added value of system
- Retailing: time (duration) of shelf-life AND mass or volume of good
- Storage and shelter, i.e. buildings and other three-dimensional infrastructure: time (duration) of use AND volume of good OR area occupied by the good
- Storage and other functions provided by places and other two-dimensional infrastructure: time (duration) of use AND area occupied by the good
- Transport and communication on roads, railways, pipes, cables, and other one-dimensional infrastructure: time (duration) AND intensity (e.g. road wearing impact by vehicles of different weight) OR bandwidth of use.
- Heating/cooling of space (keeping a temperature): time (duration of heating/cooling) AND area or volume heated/cooled (depending whether the space is used by area such as in offices, or by volume such as in staple storage halls or retail freezers)
- Heating/cooling of goods (reaching a target temperature): heat capacity of good
- Private administration services: person time or cost charged for admin services OR market value of sales
- Public administration services: person time or cost charged for admin services OR number of cases serviced
- Cleaning services (of objects of similar cleaning technologies): surface area cleaned (or as fall-back option: time (duration) of cleaning)
- Guarding services: share of product's value among guarded products AND/OR the production/provision facilities' value of the product among guarded site/object, depending what is the purpose of the guarding
- Marketing services: share of product implicitly or explicitly addressed by marketing (e.g. corporate marketing: share of product's value in corporate turnover)
- Teaching/training services: person time (duration) of training AND number of individuals taught/trained
- R&D services (of objects of similar R&D): person time OR cost charged

### Provisions: 7.9.3 Solving multifunctionality by allocation

for R&D services

#### III.b.ii) **Production processes:**

- Extraction processes: for process-related flows the market value, for product-related flows the specific physical properties of the co-products
- Chemical conversion and waste processing (including incineration): quantitative change of the to-be-allocated flows in dependency of quantitative changes in the products or functions delivered by the system. If unknown: the chemical or physical properties that determine the amount of the other flows
- Manufacturing (including physical transformation processes) and mechanical waste processing: length, surface, volume, or mass OR number of items OR time of processing
- Recycling, energy-recovery, reuse: see specific provisions in chapter 7.9.3 and details on allocation of waste inputs see annex 14.4.
- General processes by other capital goods' input directly to multifunctional processes (e.g. the processing machines themselves, but not buildings etc.): time (duration) of use OR mass, volume, length of produced good

III.c) **Justify selection from checklist:** In the case alternatives are given in the above provisions, the chosen alternative shall be concisely justified.

III.d) **Justify other criteria:** If another specific relationship is applied that is not listed above, that choice shall be concisely justified including explaining why none of the default provisions is applicable or the most suitable ones, along the guidance given in the text.

III.e) **Justify non-existence of determining physical causality:** If a "determining physical causal relationships" does not exist (i.e. it is not in the above list and no other can be identified), this shall be concisely justified. Only in that case the second allocation step should be applied (see below); otherwise the resulting lack of accuracy and potential distortion is to be documented and explicitly be considered in the results interpretation (7.9.3.3).

IV) **SHOULD - Second step and criterion "market price":** As second, general allocation criterion for multifunctional processes, the market price of the co-functions should be applied. If this is done, the price shall refer to the specific condition and at the point the co-functions leave or enter<sup>180</sup> the multifunctional unit process or are provided. This means for processes that the known, calculated or approximated market price shall relate to e.g. the specific technical characteristics in quantity and quality such as purity, compressed or not, packaged or not, etc. as well as bulk or small amounts, etc. at the point it leaves the process. If this cannot be done, the resulting lack in accuracy and potential distortion of the results shall be documented and be considered in the results interpretation.

V) **SHOULD - Two-step procedure for multifunctional products** (e.g. consumer products): The following two-step procedure<sup>179</sup> shall be applied (7.9.3.2): [ISO!]

V.a) **First step and criterion "determining physical causality":** As first criterion the

<sup>180</sup> "Enter" in case of waste and end-of-life treatment services.



### Provisions: 7.9.3 Solving multifunctionality by allocation

“determining physical causal relationships” between each non-functional flow and the co-functions of the product should be identified and applied. The above guidance for multifunctional flows can be applied analogously.

- V.b) **Use virtual subdivision principle to perform explicit allocation:** As an initial step, analogously as above for multifunctional processes, the logic of virtual subdivision should be applied to virtually subdivide the multifunctional product.
- V.c) **Second step and criterion "QFD" or "market price":**
- V.c.i) **Preferred second criterion - Quality Function Deployment:** If the above cannot be done, the Quality Function Deployment (QFD) should be used to identify the relevance of the co-function from the user's perspective. If a QFD does not exist and cannot be developed (e.g. due to cost or timing reasons), the second, general allocation criterion of "market price" of equivalent products for the single co-functions can and shall be applied (see below).
- V.c.ii) **Alternative second criterion - market price:** If the QFD is not feasible, allocation by market price should be done in analogy to the preceding case for multifunctional processes. For products, the representative price of products that provide an equivalent to each single function should be used to allocate among the co-functions of the multifunctional product. (7.9.3.3) [ISO+]
- VI) **SHALL - Attributional modelling of reuse, recycling, recovery:** The following provisions shall be applied in attributional modelling of recycling and related (the corresponding detailed explanations are found in annex 14.4): [ISO!]
- VI.a) **Follow general rules for multifunctionality, observing specific aspects:** Allocation of products from end-of-life product and waste treatment shall apply the same general rules as other cases of multifunctionality, with two specific aspects:
- VI.a.i) **Dealing with waste and end-of-life products of negative market value that generate secondary goods:** Specific is firstly that in case the market value of the end-of-life product or waste is below zero (e.g. soiled postconsumer packaging waste), the appropriate process step at the system boundary to the next life cycle is to be identified, i.e. where the allocation is to be applied. This process step is that one where the valuable co-function is created after one or more initial treatment processes have taken place (e.g. sorted plastic fraction of the above waste).
- VI.a.ii) **True joint process to be identified:** Specific is secondly that for end-of-life products and waste the true joint process is to be identified, which is separated by various e.g. manufacturing steps from the step where the end-of-life product occurs (for the concept see Figure 29):
- VI.a.ii.1) For waste or end-of-life products with a market price equal or above zero, the true joint process is that process earlier in the life cycle of the system, where the good (e.g. a aluminium bar) is technically approximately equivalent to the secondary good of the waste or end-of-life product (e.g. aluminium scrap from construction demolishing). Note that for "open loop - different

### Provisions: 7.9.3 Solving multifunctionality by allocation

primary route" recycling this step might necessarily involve abstraction to the basic properties of the two products. These two products that have been identified as described above are then considered co-products of the true joint process.

VI.a.ii.2) For waste and end-of-life products with a market value below zero, the true joint process is that one, which produces that product that is about equivalent to the first valuable product that is produced from the initial waste treatment processes, as described in the preceding provision. These two products that have been identified as described above are then considered co-products of the true joint process.

VI.a.ii.3) In the case of multiple functions from the waste or end-of-life product (e.g. a complex consumer product is discarded for recycling of its many materials and for energy recovery), there is each one true joint process for each of them that shall be identified.

VI.b) **Provisions:** The following provisions can be derived that shall be applied, differentiating between wastes / end-of-life products with negative and positive market value:

VI.b.i) **Negative market value:** If the market price of the waste / end-of-life product is below zero (see also Figure 33 and explanations in annex 0):

VI.b.i.1) The waste / end-of-life management / treatment processes until excluding the process where the pre-treated waste crosses the "zero market value" border (i.e. when a process is generating a function with positive market value) shall be allocated exclusively to the first system. In the case the exact process step or the waste and/or secondary good properties cannot be clearly identified, the resulting lack of accuracy shall be reported and later be considered in the results interpretation.

VI.b.i.2) Subsequently, the two-step allocation procedure shall be applied between the valuable secondary good and its co-product from the true joint process (i.e. see the next provision). This involves a second, additional allocation exclusively of the inventory of that process step that has produced the first valuable product after the initial waste treatment steps, as follows:

VI.b.i.3) The inventory exclusively of the process step that produces a valuable product (secondary good) should be allocated with the market value criterion between the secondary good(s) and the (potentially pre-treated) waste / end-of-life product that enters this process step. The burdens that are allocated to the pre-treated waste / End-of-life product belong to the first system, the ones assigned to the secondary good(s) to the second system(s). Note that the market value of the pre-treated waste / End-of-life product is below zero and that hence the absolute value of its

### Provisions: 7.9.3 Solving multifunctionality by allocation

(negative) market price<sup>181</sup> should be used when calculating the allocation key; the rest of the allocation calculation is the same.

- VI.b.i.4) After that, the two-step allocation is applied between the valuable secondary good and the true joint process, as follows in the next provision, i.e. analogous to the case when the waste or end-of-life product have a positive market price.
- VI.b.ii) **Market value equal or above zero:** If the market price of the waste / end-of-life product is equal or above zero, the two-step allocation procedure shall directly be applied between the process step that generates the waste or end-of-life product and the true joint process. The following procedure shall be applied (details see annex 14.4.1.2):
- VI.b.ii.1) As first criterion, the “determining physical causal relationships” between each non-functional flow and the co-functions of the process shall be identified and applied. This is worked out as follows:
- VI.b.ii.2) Two sub-cases are to be differentiated: the first one is where the secondary good is undergoing none or limited changes in the inherent properties (e.g. metal recycling, fibre recycling) and the second one is where it undergoes relevant changes in the inherent properties (e.g. energy recovery from mixed polymer waste). The first sub-case applies to all "closed loop" and "open loop - same primary route" situations. The second sub-case applies to all "Open loop - different primary route" situations.
- VI.b.ii.3) For the first sub-case, the total number of cycles and the therefrom derived the total amount of uses (considering the loss at each cycle; concept see text) is determined and used for allocation across the many uses including the initial production up to the true joint process. In result the following formula can be developed for an infinite number of loops (considering the losses at each loop) (detailed steps see annex 14.4.1):
- VI.b.ii.4) 
$$e = (P + W) * (1 - r) + R * r$$
- with
  - $e$  : average LCI per unit of material, part, or energy carrier
  - $r$  : average recycling rate [0...1), incorporating both collection efficiencies and processing efficiencies
  - $P$  : LCI of primary production per unit of material, part, or energy carrier
  - $W$  : LCI of final waste management per unit of discarded material, part, or energy carrier
  - $R$  : LCI of effort for reuse/recycling/recovery per unit of material, part, or

<sup>181</sup> E.g. if the market value / gate fee is „-1 US\$“ this would be „1 US\$“.

### Provisions: 7.9.3 Solving multifunctionality by allocation

energy carrier

- VI.b.ii.5) The allocation formula is to consider in addition the change in the inherent properties of the secondary good.
- VI.b.ii.6) If the above cannot be done because information that is required for applying the formula cannot be obtained or at least approximated, the second step of "market value" allocation needs to be applied. In that case, it must be detailed and justified why the above cannot be applied. It shall be also demonstrated that the market value allocation is not disfavours any competitor product, if the results are intended to be used for comparisons.
- VI.b.ii.7) For the second sub-case, i.e. where the recycled/recovered/reused good undergoes relevant changes in the inherent properties, the true joint process is the one along the production chain that produces the minimum required quality<sup>182</sup> of the good to generate the secondary good. (E.g. in case of soiled low value LDPE post-consumer plastic waste that is incinerated to recover the energy: As the LDPE is incinerated and basically only the lower calorific value is of interest, the minimum required good is even before the production of the LDPE - the crude oil (incl. transport to the country of LDPE production) is meeting the minimum requirements in this case.) Based on this, the general two-step allocation procedure shall be applied between the secondary good and the function(s) or the true joint process (provisions see more above).
- VI.b.ii.8) If several functions are generated from the waste / end-of-life product (e.g. different metals recovered), this shall be done individually with each of the true joint processes.

VII) SHALL - **System-wide consistent application of allocation:** Consistency shall be ensured as far as possible, using the same allocation criteria for the different co-functions of any specific process and across all similar processes within the system boundary. Otherwise, the lack of consistency and its effect on accuracy, precision and completeness shall be considered when stating the quality of a data set or when interpreting the results of an LCA study, respectively.

VIII) SHALL - **100 % rule:** The sum of the inventories allocated to all co-products shall be equal to the inventory of the system before allocation was done.

<sup>182</sup> Note that this provision ensures that the ISO 14044 provision on considering the change in inherent properties of the secondary good.

## 7.10 Calculating LCI results

(Refers to aspects of ISO 14044:2006 chapter 4.3.3)

### Overview

Depending on the level of aggregation that is required for the intended applications, the inventories of all included unit processes are scaled in relation to their share in the overall product system and are aggregated over e.g. sub-assemblies, over life cycle stages, or over the whole product system<sup>183</sup>.

When the inventory calculations are performed, it is important to be consistent in applying the same calculation procedures throughout the LCI/LCA study.

All quantitatively relevant interim products and wastes generated inside the system are to be completely modelled, if being co-products substituted or allocated, depending on the applied LCI method approach. The final LCI results hence shall represent exclusively the product prescribed by the functional unit. If the system has been modelled completely, the resulting aggregated inventory exclusively contains elementary flows (e.g. resources as inputs and emissions as outputs) that cross the system boundary in addition to the product or products, which are defined by the functional unit. One exception is radioactive waste, which can stay in the inventory as no agreed LCI modelling framework of its long-term management is available yet. Often also other co-products and wastes in however insignificant amounts can remain in the inventory, in line with the cut-off criteria. For reporting, these can be removed from the inventory (upon approval by the reviewer regarding their quantitative irrelevance).

Depending on the goal and scope of the LCI/LCA study, scenario analysis and uncertainty calculations should also be performed. This especially applies to product comparisons and more so for future strategy comparisons.

### Averaging data

See chapter 7.7.

### Provisions: 7.10 Calculating LCI results

Applies to all types of deliverables of the study, while for unit process and partly terminated system data sets as deliverables only to quantify the achieved completeness and precision, as they need to be evaluated from the system's perspective.

- I) **SHALL - Apply calculation procedures consistently:** The same calculation procedures shall be applied consistently throughout the analysed system(s) when aggregating the processes within the system boundary for obtaining the LCI results.
- II) **SHALL - Calculate and aggregate the inventory data of the system(s):** (See also 7.8. If the model is correctly prepared, the first two following sub-bullets can be skipped):
  - II.a) Determine for each process within the system boundary how much of its reference flow is required for the system to deliver its functional unit(s) and/or reference

<sup>183</sup> Note that the calculation of LCI results is also required when developing unit process data sets as deliverables of the LCA work, as it serves, together with subsequent characterisation to quantify the overall completeness and approximate the overall uncertainty of the data set per impact category. If normalisation and weighting are included in the definition of the cut-off rules, also these are to be applied.

flows(s) (i.e. the extent to which the process is involved in the system).

- II.b) Scale the inventory of each process accordingly. This way it relates to the functional unit(s) and/or reference flow(s) of the system.

Note that if parameterised process data sets are used in the system model, the parameter values are to be set before scaling and aggregation.

- II.c) The correctly scaled inventories of all processes within the system boundary shall be aggregated (summed up) for that system.

- II.d) If the intended application of the results requires a location non-generic impact assessment (as identified in 6.7.5), aggregation of the elementary flows above the required location type or level (e.g. the level of a single site/plant, a region, a country, an environmental sub-compartment, etc.) should be avoided in the LCI results calculation. The same applies for other differentiations (e.g. of environmental sub-compartments or archetypes of emission situations) if those are required for the intended application and impact assessment methods to be used. [ISO+]

- II.e) If the disaggregated data cannot be publicly disclosed (e.g. for confidentiality reasons), it is recommended to foresee performing the impact assessment on the disaggregated level and providing the LCIA results together with the aggregated LCI results. [ISO+]

Note that also in this case (as in all cases) the reviewers shall have (at least confidential) access to all underlying data.

- III) **SHOULD - Ensure that reference flow(s) is/are only product and waste flow(s):** Note that after aggregation, the reference flow(s) is/are the only product and/or waste flow(s) that should remain in the LCI results inventory, with two exceptions:

- III.a) **For partly terminated systems:** The inventories of selected products and/or waste flows were left out of the system boundary - typically intentionally - and the flows are kept in the inventory. Note however that for the purpose of quantifying the achieved completeness via the cut-off rules of environmental impact, also these selected product and waste flows are to be considered via integrating the inventories of the respective production and waste treatment processes.

- III.b) **For radioactive waste and waste in underground waste deposits (e.g. mine filling):** These waste flows can be kept in the inventory for direct use in interpretation (see chapter 7.4.4.2).

- IV) **SHALL - Highlight and explicitly consider remaining non-functional product or waste flows:** Any product and waste flows that remain in the inventory and that are non-functional flows shall be highlighted in the report and/or data set: Either they require to be modelled when later using the data set (e.g. by complementing the data set with a yet missing background LCI data set for e.g. a specific chemical consumed, or modelling the management/treatment of a specific waste). Or this gap / missing data needs to be explicitly considered in subsequent interpretation and conclusions drawn.

# 8 Life Cycle Impact Assessment - calculating LCIA results

(Refers to ISO 14044:2006 chapter 4.4)

## 8.1 Introduction and overview

(Refers to aspects of ISO 14044:2006 chapter 4.4.1, 4.4.2, and 4.4.3)

### General

Life Cycle Impact Assessment (LCIA) is the phase in an LCA where the inputs and outputs of elementary flows that have been collected and reported in the inventory are translated into impact indicator results related to human health, natural environment, and resource depletion.

It is important to note that LCA and the impact assessment is analysing the potential environmental impacts that are caused by interventions that cross the border between technosphere and ecosphere and act on the natural environment and humans, often only after fate and exposure steps. The results of LCIA should be seen as environmentally relevant impact potential indicators, rather than predictions of actual environmental effects. LCA and LCIA are equally distinct from risk based, substance specific instruments.

See also the related notes in the guidance document "Framework and requirements for Life Cycle Impact Assessment (LCIA) models and indicators".

### Overview

LCIA is composed of mandatory and optional steps, as reflected also by the subchapters:

- Based on classification and characterisation of the individual elementary flows, which is usually done by LCIA experts that provide complete sets of LCIA methods for use by LCA practitioners<sup>184</sup> (see separate guidance document "Framework and requirements for Life Cycle Impact Assessment (LCIA) models and indicators"), the LCIA results are calculated by multiplying the individual inventory data of the LCI results with the characterisation factors (8.2)
- In a subsequent<sup>185</sup>, optional step, the LCIA results can be multiplied with normalisation factors that represent the overall inventory of a reference (e.g. a whole country or an average citizen), obtaining dimensionless, normalised LCIA results (8.3)
- In a second optional step these normalised LCIA results can be multiplied by a set of weighting factors, that indicate the different relevance that the different impact categories (midpoint level related weighting) or areas-of-protection (endpoint level related weighting) may have, obtaining normalised and weighted LCIA results that can be summed up to a single-value overall impact indicator (8.4). Note that a weighting set always involves value choices.

---

<sup>184</sup> Note that the development or variation/adjustment of LCIA methods is never done by the vast majority of normal LCA practitioners, but by special LCIA experts, whose LCIA methods and factors the LCA practitioners use and rely on. For this reason and also to avoid that LCIA methods are selected after the LCI results have been calculated and based on interests, the aspects of selecting or adjusting LCIA methods are entirely addressed in the scope chapter 6.7. This current chapter refers hence exclusively to the calculation of the LCIA results.

<sup>185</sup> ISO 14044 also foresees an optional "Grouping" step. No specific recommendations are given here. If it is decided to apply a grouping step, the ISO 1444 provision can be applied.

The LCIA phase prepares additional input for the interpretation phase of the LCI/LCA study.

### Impact assessment, normalisation and weighting for applying cut-off criteria

Note, that even if the application of the LCI/LCA study does not require to report any impact assessment results (e.g. when developing a cradle-to-gate LCI results data set for a specific product for customer information), it is still relevant to perform an impact assessment of the data set as part of the LCI/LCA study: This is because of the iterative approach to LCA where the achieved level of completeness and precision (cut-off criteria) of the LCI data set is to be judged on its LCIA results.

The LCIA results are hence also the basis for a sensitivity analysis to support identification of the main contributing elementary flows and of the processes causing them, as part of the stepwise improvement of the inventory data. This may include the use of normalisation and weighting, if it has been decided to implement the cut-off criteria in relationship to the normalised and weighted LCIA results.

### LCIA in comparative studies

In comparative LCA studies, an impact assessment must be performed in addition, calculating the final LCIA results that are an important component of the basis for the interpretation phase, and the conclusions and recommendations must be based on the outcome of the LCIA results.

### Expressing LCIA results

LCIA results of the individual impact categories are typically expressed as equivalent values if this is a midpoint level indicator (e.g. kg CO<sub>2</sub>-equivalents for the Global Warming Potential GWP) or damage values for endpoint level indicators (e.g. DALYs for Human health, PDF\*m<sup>2</sup>\*a for Natural environment / Species diversity impacts)<sup>186</sup>. Note that the formal measurement units of the above three examples are kg, a, and m<sup>2</sup>\*a, respectively, while for better communication the initially named expressions are most widely used.

## 8.2 Calculation of LCIA results

(Refers to aspects of ISO 14044:2006 chapters 4.4.2 and 4.4.3)

### Calculating LCIA results

Using the LCIA methods as identified in the scope phase<sup>187</sup> of the LCI/LCA study (chapter 6.7.2), now the LCIA results are to be calculated. While ISO is not addressing the development of LCIA methods in any detail, it formalises the link between the inventory elementary flows and the impact assessment factors, as follows:

The impact assessment at midpoint and/or endpoint level is performed by first assigning the elementary flows to the one or more relevant categories of impact. This step is called "Classification" (see also Figure 15). Then the inventory results for the individual elementary flows are usually linearly<sup>188</sup> multiplied with the relevant impact factors from the applied LCIA methods; this step is called "Characterisation". Details are provided in the separate guidance

---

<sup>186</sup> For definitions and details see the separate document "Framework and requirements for Life Cycle Impact Assessment (LCIA) models and indicators".

<sup>187</sup> See that chapter for the explanation why this shall be done in the scope phase and not only after LCI data collection and modelling.

<sup>188</sup> Certain LCIA methods use non-linear relationships for the characterisation.



document "Framework and requirements for Life Cycle Impact Assessment (LCIA) models and indicators" on the development and selection of Life Cycle Impact Assessment models and factors.

In LCA practice, these steps are not regularly done by LCA practitioners, but this is part of the work towards developing LCIA methods. The practitioner is however responsible to ensure that the inventory elementary flows are correctly linked with the LCIA factors (see more below) and - together with LCIA experts - to derive or develop missing impact factors if potentially relevant for the study (details see chapter 6.7.4).

The resulting characterized indicator results can be summed up within each impact category. The resulting collection of aggregated indicator results is the characterized impact profile of the product, i.e. its LCIA results.

### **No comparison across impact categories**

As the LCIA results per impact category have different units, they cannot directly be compared to identify which are most relevant. Equally it cannot be summed up.

### **Ensure a correct link between inventory and impact factors**

Databases within LCA software typically provide elementary flows that have been classified and characterised and thereby "linked" with the LCIA methods. The practitioner is however responsible to ensure that the inventory elementary flows are correctly linked with the LCIA factors. This in any case applies for elementary flows that were added by the practitioner during data collection and for newly applied LCIA methods. The work of correctly linking inventory and impact factors is supported by using the same nomenclature and flow data sets, e.g. the ILCD nomenclature and related reference elementary flows.

### **Frequent errors: Incomplete LCIA factor assignment to elementary flows**

In LCA databases of diverse origins of the data (e.g. combined by the software/database provider or growing over the years at the practitioner) typically have a number of elementary flows that should carry a characterisation factor in the covered LCIA methods, but don't have it assigned. That means the impact assessment is incomplete and – depending on the relevancy of the gaps – leads to wrong results and conclusions. Some of the main "candidates" for such omissions and possible solutions<sup>189</sup> are as follows. The related provisions are found in the referenced chapters (here below the provision status is given only for orientation):

- Combined ores (e.g. "Lead-zinc ore; 2.5 % Pb, 1.8 % Zn" as "Resources from ground" that were created by the practitioner or imported from the database developers). Possible solution:
  - a) (not permissible<sup>190</sup>.) Calculate the resource depletion factors of the single elements, scale them to the respective element contents of the flow, sum them up and assign the resulting factor to that flow.
  - b) (shall:) Avoid specific ore resource flows by splitting the ore flow up into the

<sup>189</sup> These cases and possible solutions have been considered and are in line with the ILCD „Nomenclature and other conventions“ guidance, the chapter on overarching methodological issues (annex 7.4.3) and are implemented in the related ILCD reference elementary flows.

<sup>190</sup> "not permissible" refers here to reporting for external use, as the respective flows would not meet the provisions of the "Nomenclature and other provisions" (see separate document) and/or the "Overarching method provisions for specific elementary flow types" (see chapter 7.4.3).

flows of the contained chemical elements and use the respective elementary flows that already have impact factors assigned (i.e. for the above example to "Lead" as "Resources from ground" and "Zinc" as "Resources from ground" and a complementary "Inert rock" as "Resources from ground" for the mass balance.) Note that for some ores the compound may need to be inventoried (e.g. Rock salt (NaCl)); details see chapter 7.4.3.6.2.

- Composed emissions such as e.g. salts (e.g. Ammonium nitrate, while characterisation factors exist for the contained ions Ammonium and Nitrate). Possible solution:
  - a) (not permissible:) Calculate the correct factor stoichiometrically (or other method, as appropriate) and assign to the flow.
  - b) (shall:) Inventory the components as separate elementary flows (e.g. "Ammonium" and "Nitrate" for the above example). See also chapter 7.4.3.3 on when to split elementary flows of salts depending on their water solubility.
- Process-type specific (composed) emissions such as "Diesel engine off-gas" etc., which cannot be usefully addressed in impact assessment and which typically have no impact factor at all and that shall not remain in the inventory. Possible solution:
  - a) (should:) Inventory the specific substances emitted if data is available or
  - b) (may) Estimate the composition by using technology-specific information on emission-composition or default break-down tables (documenting assumptions made) and inventory the individual substances emitted.
- Newly user-created flows of e.g. emissions that even may have a factor in the used LCIA method but that were not provided with the LCA database package or software. Possible solution:
  - First check whether the package is complete; obtain the missing factors. For flows that were newly created by the user, it should be verified that it is not actually an existing flow but named with an e.g. trivial name or an alternative chemical name. CAS numbers help in verifying this.
- Emissions to sub-compartments or at specific locations for which no specific impact factor is available. Possible solution:
  - a) (recommended) Avoid use of such flows unless specific factors are available in the applied LCIA method for all quantitatively relevant elementary flows, or
  - b) (shall) Assign the impact factor of the same elementary flow of the parent compartment (e.g. the impact factor for "Nitrate" as "Emissions to freshwater" is also assigned to "Nitrate" as "Emissions to lakes"). See the separate document "Nomenclature and other conventions" for applicable default compartments.
- Sum-indicators such as "Metals" and measured indicators, which cannot be usefully addressed in impact assessment and which typically have no impact factor at all and that shall not remain in the inventory. Possible solution:
  - a) (should) Inventory the individual substances (e.g. for the sum-indicator "Metals" the individual "Lead", "Iron", etc. metals), if composition information is available, or
  - b) (may) Estimate the composition by using technology-specific information on

emission-composition or default break-down tables (documenting assumptions made) and inventory the individual substances emitted. See chapter 7.4.3.2 for permissible sum-indicators.

- Unspecified “Biomass”, “Renewable energy”, “Unspecified emissions”, etc. elementary flows. Possible solution:
  - a) (should) Inventory the individual components if data is available, or
  - b) (may) Estimate the composition by using technology-specific information on composition or default break-down tables or a typical generic case (documenting assumptions made) and inventory the individual substances emitted.

Note: Check also whether the respective flow is potentially relevant (along process-specific worst-case assumptions) and remove it from the inventory if clearly not relevant in line with the applied cut-off rules.

### **Additional, modified, or non-generic / differentiated LCIA methods**

As already mentioned in chapter 6.7, in case the inventory work reveals the need to address additional impacts that were not originally considered, the respective scope step has to be revised. In summary: If a characterisation factor is missing for an elementary flow in the inventory, which is known to contribute to an impact category, its potential importance should be checked. If the contribution from the elementary flow is found to be potentially significant, an attempt should be made to estimate the missing characterisation factor, and if this is not possible, the fact of a potentially relevant missing characterisation factor must be reported, and the potential influence of the missing factor must be considered in the interpretation of the results.

### **Normalisation and weighting necessary?**

The decision of inclusion/exclusion of normalisation and weighting shall have been made and documented in the initial scope definition (see chapter 6.7.7). Note that normalisation and weighting may be required as interim step for defining the quantitative cut-off rules (see chapter 6.6.3) and for checking the achieved completeness of the inventory (see chapter 9.3.2); this depends on the chosen approach for implementing the cut-off rules. If used exclusively for this purpose, the respective normalised and weighted figures are not staying in the data set or report.

In comparisons without normalisation and weighting, LCIA results of the different impact categories or damages/areas-of-protection may point to different directions, i.e. for different impact categories not always the alternative product performs best. However, if the study is intended to support a comparative assertion to be disclosed to the public, no form of numerical, value-based weighting of the indicator results is permitted to be published in accordance with ISO 14040 and 14044:2006.

For in-house purposes, the use of normalisation and weighting – preferably using several different approaches and value perspectives - can help to demonstrate the robustness of the analysis.

If in contrast all impact indicators point into the same direction, the LCIA results can already be the basis for interpretation phase of the LCA, including for comparative studies, clearly identifying a superior alternative (or, in case of limited significance of the differences, identifying equality of the compared alternatives).

## Provisions: 8.2 Calculation of LCIA results

Note that this provision applies to all types of deliverables of the study, while for unit process, partly terminated system and LCI results data sets as deliverables only to quantify the achieved completeness and precision, as they need to be evaluated from the system's perspective.

Note: If third-party LCIA methods are used that correctly provide characterisation factors for all used elementary flows, the first two following provisions mean to exclusively control that this has been done correctly. For any newly created elementary flow however, the characterisation factor has to be assigned and/or developed (see also chapter 6.7.4):

- I) **SHALL - Classification of elementary flows:** All elementary flows of the inventory shall be assigned to those one or more impact categories to which they contribute ("classification") and that were selected for the impact assessment in the scope definition of the study.
- II) **SHALL - Characterisation of elementary flows:** To all classified elementary flows each one quantitative characterisation factor shall be assigned for each category to which the flow relevantly contributes ("characterisation"). That factor expresses how much that flow contributes to the impact category indicator (at midpoint level) or category endpoint indicator (at endpoint level). For midpoint level indicators this relative factor typically relates to a reference flow (e.g. it may be expressed in "kg CO<sub>2</sub>-equivalents" per kg elementary flow in case of Global Warming Potential). For endpoint level indicators it typically relates to a specific damage that relates to the broader area of protection. Examples are e.g. species loss measured e.g. as potentially displaced fraction of species for an affected area and duration (pdf\*m<sup>2</sup>\*a), or damage to Human health measured e.g. in Disability Adjusted Life Years (DALYs). (For terms and details refer to the separate document "Framework and requirements for Life Cycle Impact Assessment (LCIA) models and indicators").
- III) **SHALL - Calculate LCIA results per impact category:** For each impact category separately, calculate the LCIA indicator results by multiplying<sup>191</sup> the amount of each contributing (i.e. classified) elementary flow of the inventory with its characterisation factor. The results may be summed up per impact category, but summing up shall not be done across impact categories.  
  
Note that this is done with either the midpoint level (impact potential) or the endpoint level (damage) factors, as had to be decided in scope chapter 6.7.7.
- IV) **SHALL - Separately calculate LCIA results of long-term emissions:** LCIA results of long-term emissions (i.e. beyond 100 years from the time of the study) shall be calculated separately from the LCIA results that relate to interventions that occur within 100 years from the time of study. [ISO!]  
  
Note: Given the different extent of uncertainty, these two sets of results will later be presented separately while discussed jointly.
- V) **SHALL - Separately calculate non-generic LCIA results, if included:** In the case additional or modified, non-generic (e.g. geographically or otherwise differentiated) characterisation factors or LCIA methods are used, the results applying the original, generic LCIA methods shall be calculated (and later be presented and discussed)

<sup>191</sup> Certain LCIA methods use non-linear relationships for the characterisation; if such are used the calculation is non-linear.

separately as well. [ISO!]

- VI) **SHOULD - Keep results of non-LCA impacts separate:** For LCIA results of impacts that are outside the LCA frame<sup>93</sup> but that were considered relevant for the analysed or compared system(s) and have been included quantitatively, the inventory, impact assessment, etc. shall be kept separately for clear interpretation. [ISO+]

Note that classification and characterisation of all elementary flows is typically already done in combined LCI / LCIA database packages or LCA software. In any case this is to be checked responsibly by the LCA practitioner. The step of manual classification and assigning characterisation factors applies hence especially to newly created or imported elementary flows. It is one of the most widely found errors to not classify and characterise newly introduced flows despite of their environmental relevance. The "frequent errors" box in the main text of this chapter provides some guidance for identifying and solving such cases.

## 8.3 Normalisation<sup>192</sup>

(Refers to ISO 14044:2006 chapter 4.4.3.2)

### Introduction and overview

Normalisation is an optional step under ISO 14044:2006. It supports the interpretation of the impact profile and is the first step<sup>193</sup> towards a fully aggregated result that additionally requires a weighting across indicators (see next chapter).

Normalised LCIA results give for each impact topic on midpoint level (e.g. Climate change, Eutrophication, etc.) or area of protection on endpoint level (e.g. Human health, Natural environment, Natural resources) the relative share of the impact of the analysed system in the total impact of this category per average citizen or globally, per country, etc. When displaying the normalised LCIA results of the different impact topics next to each other, it can hence be seen to which impact topics the analysed system contributes relatively more and to which less.

Also to implement the cut-off criteria, weighted and normalised LCIA results can be used (see chapter 6.6.3). If this approach has been chosen, normalisation is a required step for all kinds of deliverables of the LCI/LCA study.

The decision about inclusion of normalisation and the used normalisation basis has been made and documented in the first scope definition; it is binding and shall not be changed later during the study (see chapter 6.7.6).

### Calculating normalised LCIA results

Normalised LCIA results are obtained by dividing the LCIA results by the normalisation basis, separately for each impact category (for midpoint level related approaches) or area of protection (for endpoint level related approaches).

### No comparison across impact topics

The different impact topics on midpoint level are typically understood to be of different absolute relevance (e.g. the issue Climate change may be judged to be more important than

<sup>192</sup> "Grouping" is not addressed in this guidance document as not seen as adding practical value in context of decision support. If it is planned to include a grouping step in an LCA study, please refer to the ISO 14044 provisions.

<sup>193</sup> Note that there are also weighting approaches that do not include an initial normalisation step. Note furthermore that also for endpoint / damage modelling a weighting is required (across the areas-of-protection) if a single indicator is aimed at.

Acidification). They reflect only the contribution of the analysed product to the total impact potential but not the severity/relevance of the respective total impact. Therefore, also the normalised LCIA results should not directly be summed: summing them up directly is equivalent to choose an equal weight for all impact categories. Hence, a weighting is always at least implicitly involved when summing up normalised LCIA results. If summing or comparison across the normalised LCIA results is intended, this shall include a explicit weighting step with equal weights.

The same holds true for normalised LCIA results on endpoint level, as the damage to e.g. the Natural environment may be judged as a more relevant issue than e.g. the depletion of Natural resources.

To directly compare or sum up results across categories or areas of protection, an additional weighting step is to be done, which is equally an optional step under ISO 14044:2006.

### Provisions: 8.3 Normalisation

Note that this provision applies to all types of deliverables of the study, while for unit process, partly terminated system, LCI results and LCIA results data sets as deliverables only if the use of normalised and weighted LCIA results has been selected to quantify the achieved completeness and precision (these need to be evaluated from the system's perspective).

I) Normalisation is mainly applied for two purposes:

I.a) **MAY - Normalisation to support interpretation:** In support of the interpretation of the results of the study, normalisation is an optional step under ISO.

The decision whether to include normalisation in the interpretation has been made in scope chapter 6.7.7.

I.b) **MAY - Normalisation use in cut-off quantification:** For quantification of the achieved completeness / cut-off, in a first step the indicator results for the different impact categories may be normalised by expressing them relative to a common reference, the normalisation basis ("normalisation"). [ISO+]

The decision whether to include normalisation in the cut-off has been made in scope chapter 6.7.7.

The specific normalisation basis has been identified in the scope chapter 6.7.6.

II) **SHALL - Calculate normalised LCIA results per impact category:** If normalisation is applied, the "normalised LCIA results" shall be calculated by dividing the LCIA results by the normalisation basis. This shall be done separately for each impact category (for midpoint level approaches) or area of protection (for endpoint level approaches).

Note that normalised results shall not directly be summed up across different impact categories as this would imply an even weighting of all impact categories. This is unless this even weighting is intended and identified explicitly as weighting when communicating the results.

## 8.4 Weighting

(Refers to ISO 14044:2006 chapter 4.4.3.4)

### Introduction

Weighting is an optional step under ISO. Weighting involves assigning distinct quantitative weights to all impact categories expressing their relative importance. If needed for the

interpretation, and if in accordance with the goal of the LCI/LCA study, a weighting of the normalised indicator results may be performed.

Also to implement the cut-off criteria, the use of weighted and normalised LCIA results is used. Hence for this purpose, weighting is a required step under the ILCD for all kinds of deliverables of the LCI/LCA study.

The decision about inclusion of weighting and the used weighting has been made and documented in the first scope definition; it is binding and shall not be changed later during the study (see chapter 6.7.7).

### Calculating weighted and normalised LCIA results

In weighting, the (typically<sup>194</sup> initially normalised) LCIA results for the different impact categories are each multiplied with a relative weighting factor.

### Comparison across impact topics

The normalised and weighted LCIA results can subsequently also be summed up across all impact categories or areas-of-protection.

Note that under ISO 14044:2006 weighting shall not be used in studies leading to comparative assertions intended to be disclosed to the public.

## Provisions: 8.4 Weighting

Note that this provision applies to all types of deliverables of the study, while for unit process, partly terminated system, LCI results and LCIA results data sets as deliverables only if the use of normalised and weighted LCIA results has been selected to quantify the achieved completeness and precision (these need to be evaluated from the system's perspective).

I) Weighting is mainly applied for two purposes:

I.a) **MAY - Weighting to support interpretation:** In support of the interpretation of the results of the study, as an additional, optional element one may perform a "weighting" or other valuation of the - method-wise normalised or not normalised - indicator results.

The decision whether to include weighting in the interpretation has been made in scope chapter 6.7.7.

I.b) **MAY - Weighting use in cut-off quantification:** For quantification of the achieved completeness / cut-off, as second<sup>195</sup> step the normalised indicator results for the different impact categories may be weighted across the indicators ("weighting"). [ISO+]

The decision whether to include weighting in the cut-off has been made in scope chapter 6.7.7.

The specific weighting set has been identified in the scope chapter 6.7.6.

II) **SHALL - Calculate weighted LCIA results per impact category:** If weighting is applied, to obtain "weighted LCIA results", the (typically normalised) LCIA results shall be multiplied by the weighting set, separately for each impact category (for midpoint

<sup>194</sup> Note that this is no free choice, but the chosen specific weighting method either requires a preceding normalisation or a preceding normalisation shall not be done.

<sup>195</sup> Note that some weighting methods work without a separate, preceding normalisation, as the normalisation is part of the weighting step.

level approaches and in case of having calculated category-wise endpoint results) or Area of protection (for endpoint results that cover each a whole area of protection). The resulting weighted LCIA results can be summed up across the impact categories or areas of protection, respectively.

- III) **SHALL - No weighting in published comparative assertions:** Weighting shall not be used in studies leading to comparative assertions intended to be disclosed to the public.

Note that the setting or selection of weighting factors necessarily involves value choices.



## 9 Life cycle interpretation

(Refers to ISO 14044:2006 chapter 4.5)

### 9.1 Introduction and overview

(Refers to ISO 14044:2006 chapter 4.5.1)

The Interpretation phase of an LCA has two main purposes that fundamentally differ:

- During the iterative steps of the LCA and for all kinds of deliverables, the interpretation phase serves to steer the work towards improving the Life Cycle Inventory model to meet the needs derived from the study goal.
- If the iterative steps of the LCA have resulted in the final LCI model and results, and especially for comparative LCA studies (while partly also applicable to other types of studies), the interpretation phase serves to derive robust conclusions and - often - recommendations.

In life cycle interpretation, the results of the life cycle assessment are appraised in order to answer questions posed in the goal definition. The interpretation relates to the intended applications of the LCI/LCA study and is used to develop recommendations.

The life cycle interpretation is the phase of the LCA where the results of the other phases are hence considered collectively and analysed in the light of the achieved accuracy, completeness and precision of the applied data, and the assumptions, which have been made throughout the LCI/LCA study. As said, in parallel to performing the LCI work this serves to improve the LCI model.

If aimed at (e.g. in case of a comparative study or a weak-point analysis), the final outcome of the interpretation should be conclusions or recommendations, which are to respect the intentions and restrictions of the goal and scope definition of the LCI/LCA study. This especially relates to the appropriateness of the functional unit and the system boundaries, as well as the achieved overall data quality, in relation to the goal. The interpretation should present the results of the LCA in an understandable way and help the user of the LCI/LCA study appraise the robustness of the conclusions and understand any potential limitations of the LCI/LCA study.

Some of the elements of the interpretation (namely completeness and sensitivity analysis, as well as potentially uncertainty analysis for the determination of precision) are hence also applied throughout the LCI/LCA study. This is done together with quality checks on the level of unit process data, LCI results and applying impact assessment as part of the iterative loops which are used in the drawing of the system boundaries and collection of inventory data (see chapter 4). The last step of conclusions and recommendations is only done in the end of the study, if conclusions and recommendations are aimed at.

The interpretation proceeds through three activities as schematically illustrated in Figure 25 and detailed in the subchapters of this chapter:

- First, the significant issues (i.e. the key processes, parameters, assumptions and elementary flows) are identified (as discussed in chapter 9.2).
- Then these issues are evaluated with regard to their sensitivity or influence on the overall results of the LCA. This includes an evaluation of the completeness and consistency with which the significant issues have been handled in the LCI/LCA study (chapter 9.3).

- Finally, the results of the evaluation are used in the formulation of conclusions and recommendations from the LCA study (chapter 9.4).
- In the cases where the study involves comparisons of two or more systems, additional considerations are to be included in the interpretation (also chapter 9.4).

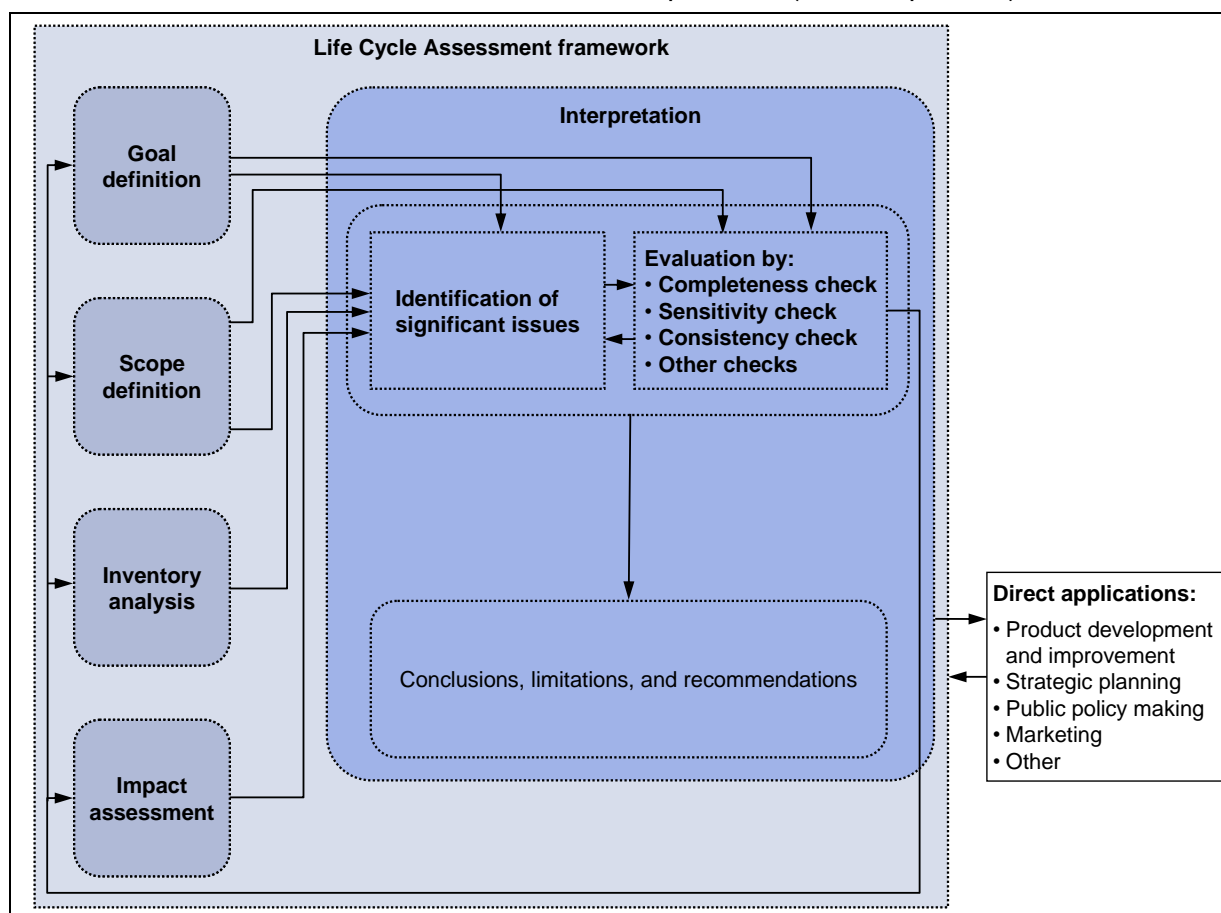

**Figure 25** The elements of the interpretation phase and their relations to other phases of the LCA and within the interpretation phase (from ISO 14044:2006, modified)

## 9.2 Identification of significant issues

(Refers to ISO 14044:2006 chapter 4.5.2 and to aspects of 4.4.4)

### Overview

The purpose of this first element of interpretation is to analyse and structure the results of earlier phases of the LCI/LCA study in order to identify the significant issues. There are two interrelated aspects of significant issues:

Firstly, there are the main contributors to the LCIA results, i.e. the most relevant life cycle stages, processes and elementary flows, and the most relevant impact categories. They are important for the overall interpretation of the LCI/LCA study and for eventual recommendations. They are to be identified through a contribution analysis (also called gravity analysis), i.e. by quantifying, which contributor contributes how much to the total, resulting e.g. in stacked columns or the well-known pie charts. In the case of future scenario LCA, the contribution analysis is to be combined/build upon a scenario modelling and analysis.

Secondly, there are the main choices that have the potential to influence the precision of the final results of the LCA. These can be methodological choices (including the LCI

modelling principles, and LCI method approaches applied, cut-off decisions and other system boundary settings), assumptions, foreground and background data used for deriving the process inventories, LCIA methods used for the impact assessment, as well as the optionally used normalisation and weighting factors. Significant choices are to be identified in a different way than the main contributors: by running the different possible choices as scenarios and comparing the scenario results.

### **Contribution analysis (weak point analysis, gravity analysis)**

Several interests and applications can require to apply the contribution analysis:

- Identify the need for further data collection or data quality improvement by quantifying the completeness of the inventory.
- Focus further data collection efforts on the most contributing processes and individual elementary flow interventions.
- Focus efforts in ecodesign and product improvement / development on the most contributing processes and individual elementary flow interventions.
- Communicate the share of internal vs. external contribution to the overall environmental impact in context of customer or stakeholder communication.
- Contribute to internal quality control during the LCA work by investigating the qualitative and quantitative plausibility of the detailed outcome of the contribution analysis; this is part of the interim and final evaluation of the LCI/LCA study results.

Depending on the drivers, inventory data-related significant issues are to be identified among whole life cycle stages, producer internal / external processes, groups of activities (e.g. transportation, energy production, services), key processes, and/or key elementary flows / interventions. If key processes of the system are parameterised, these parameters can equally be significant issues.

The analysis is typically done on multiple levels, e.g. for LCIA results: firstly in relation to the individual elementary flows, secondly in relation to the individual impact categories on midpoint and/or category endpoints on endpoint level, and thirdly in relation to the overall (normalised and weighted) environmental impact. The third step is in general also called dominance analysis.

In practice the contribution analysis is supported by professional LCA tools, or can be done by analysis of the inventory and LCIA result tables in spreadsheet software.

### **Significant issues for unit processes and partly terminated systems**

On the level of a unit process, the most significant issues can only be identified for the elementary flows that are directly related to that process. This is because the inventories of any input products and subsequent waste management processes are not included in the unit process' inventory. To nevertheless be able to quantify which flows are the most significant ones for the analysed unit process, it is necessary to include the life cycle inventories of the named products and waste management processes before the contribution analysis is done. The above applies analogously for partly terminated systems data sets.

#### **Provisions: 9.2 Identification of significant issues**

This provision applies to all types of deliverables of the study, but for unit process, partly terminated systems, LCI results and LCIA results data sets as deliverables only to improve the data quality during the iterative loops of developing the LCI data or the system model. (Findings may also be included in an LCI study report.)

- l) **SHALL - Identify significant issues:** These can be among the following:
- I.a) **Inventory items:** Main contributing “key” life cycle stages, processes, product, waste and elementary flows, parameters. This part is also known as weak point analysis or gravity analysis. Use contribution analysis techniques.
  - I.b) **Impact categories:** Main contributing “key” impact categories (only identifiable if weighting was applied). Use contribution analysis techniques.
  - I.c) **Modelling choices and method assumptions:** Relevant modelling choices, such as applied allocation criteria / substitution approaches in the inventory analysis, assumptions made when collecting and modelling inventory data for key processes and flows, selecting secondary data, systematic choices on technological, geographical, and time-related representativeness, methodological consistency, extrapolations, etc. Use scenario analysis techniques.
  - I.d) **Commissioner and interested parties:** The influence of the commissioner and interested parties on decisions in goal and scope definition, modelling choices, weighting sets and the like. Discuss influences on final results and recommendations. [ISO!]

Note: For analysing the significant issues of unit processes and partly terminated systems, complete the system model as appropriate (e.g. cradle-to-gate) with a background system before the contribution analysis is done (see chapters 7.8). Focus the contribution analysis to the unit process / partly terminated system itself (i.e. the significant flows, assumptions, parameters, processes etc. within the original system boundary).

Note: the "informative" annex B of ISO 14044:2006 provides a range of examples of life cycle interpretation, including but not only on the identification of significant issues.

## 9.3 Evaluation

(Refers to ISO 14044:2006 chapter 4.5.3)

### 9.3.1 Introduction and overview

(Refers to ISO 14044:2006 chapter 4.5.3.1)

#### Evaluation of final results

The evaluation element is performed to establish the foundation for subsequently drawing the conclusions and provide recommendations during the interpretation of the LCI/LCA study results (see chapter 9.4). The evaluation is performed in close interaction with the identification of significant issues (see preceding chapter 9.2) in order to determine the reliability and robustness of the results.

The evaluation builds upon the results of the earlier phases of the LCA and analyses the LCI/LCA study in an integrated perspective, i.e. based on the outcome of the inventory data collection, inventory modelling, and impact assessment. It is done in accordance with the goal and scope of the LCI/LCA study, and its focus is on the significant issues identified among methodological choices and data.

The evaluation involves:

- completeness check (9.3.2),
- sensitivity check in combination with scenario analysis and potentially uncertainty analysis (9.3.3), and
- consistency check (9.3.4).

The outcome of the evaluation is crucial to give strength to the conclusions and recommendations from the study, and it must therefore be presented in way which gives the commissioner and intended audience of the study a clear understanding of the outcome.

Note that depending on the goal and scope of the LCI/LCA study, different steps of the evaluation may need to be applied. For example, it is only for comparisons between systems that comparative conclusions will be drawn. This is thus not the case when e.g. LCI results data sets are the deliverables of the LCI/LCA study and Environmental Product Declarations (EPD) are the intended applications. However, most steps of the evaluation are nevertheless always required, as non-comparative results such as e.g. LCI data sets may be foreseen to be used as background data for comparative questions on other systems. To correctly inform subsequent data set users, the completeness and consistency of the data set's inventory is to be evaluated. Equally is the applicability of specific LCIA methods to be checked, by evaluating the assignment of the elementary flows to the applicable/supported impact models.

### **Evaluation as part of the iterative steps of LCI/LCA study**

Using the same methods and approaches as for the final evaluation of the LCI/LCA study, the evaluation is also used during the development of the LCA to analyse the achieved completeness, accuracy, precision and consistency. It serves to identify needs for additional or better data as well as revision of assumptions made and other methodological choices.

## **9.3.2 Completeness check**

(Refers to ISO 14044:2006 chapter 4.5.3.2)

### **Overview**

Completeness checks on the inventory are performed in order to determine the degree to which it is complete and whether the cut-off criteria have been met. If the cut-off criteria are not (yet) met, additional or better data is to be used in order to satisfy the goal and scope of the LCA. When performing the completeness check, missing, but relevant LCIA factors and elementary flows are to be semi-quantitatively considered.

Alternatively and if the cut-off criteria cannot be met, the goal and scope definition may have to be adjusted to accommodate the lack of completeness. This may however mean that the original questions of the goal cannot be answered any more or that developed data does not meet the aimed at quality.

The challenge of the completeness check, that was already mentioned earlier, is to overcome the seemingly paradox to judge the degree of completeness of the inventory while the absolute numbers of the complete inventory cannot be known. This problem is solved as described below.

As a general rule, it is recommended to include as many elementary flows as possible in the inventory to allow the (internal or external) user to perform a detailed impact assessment and analysis. This is also advisable to be able to answer potential questions on possible missing flows that may come from reviewers or third parties (if the data is foreseen to be published/distributed). As a minimum, all elementary flows of quantitative relevance to the overall environmental impact of the process or system, which are addressed in the impact assessment, should be included.

It is important to understand that the % completeness achieved must not be misinterpreted that it would indicate the exact 100 % completeness. However does the achieved completeness indicate the approximate true value (Note that this value has a higher uncertainty, the lower the % of approximated completeness is.) Any difference in

achieved completeness across compared alternatives must accordingly be considered when interpreting the results, drawing conclusions and giving recommendations: i.e. if one option has e.g. 95 % completeness and the other 90 %, that difference must be considered.

### Operationalising cut-off criteria during unit process development

The overall cut-off criteria (e.g. "90 % completeness") were defined in the scope definition phase of the LCI/LCA study. Their translation into operational cut-off criteria during data collection of the individual unit process can be done using the following combined criteria:

- For product flows: "mass" (of individual key chemical elements) AND "energy content"<sup>196</sup> AND "market value" (or "production/provision cost"). The market value is especially relevant for services, which often have no mass and no relevant energy content.
- For waste flows: "mass" (of individual key chemical elements) AND "energy content" AND "treatment cost"
- For elementary flows: "mass" (of individual key chemical elements and only for the environmentally relevant flows, i.e. excluding not or less relevant flows such as e.g. incineration air consumed and waste steam leaving the process as emission to air) AND "energy content"
- In addition, those emissions and wastes should be included that have a low mass or energy content and do not cause direct costs but are of known relevance for the respective type of process or industry. This is given, if the respective emission is regulated or to be reported for the respective process or a technically similar process or industry (also in other countries with comparably strict regulations, e.g. the U.S. or Japan or the EU).

Balances between input and output of these criteria and performed jointly across all flow types will help identifying relevant gaps or errors in by far most cases.

While the finally achieved degree of completeness shall primarily be judged along the overall environmental impact or impact category by impact category, as detailed in chapter 6.6.3, the above steps help during the life cycle inventory work to efficiently complete the data with high quality data, given the practical restrictions. Note that for comparative assertions, the cut-off shall always be met also by mass and energy (as also required in ISO 14044).

Before illustrating how this looks in practice, the 100 % reference needs to be identified:

### Approximating the 100 % value

As a necessary, preceding step before the achieved completeness can be approximated, the 100 % value of the "complete" inventory and impact is to be approximated. It is seemingly a paradox to already initially know the final outcome, i.e. what is the 100 % of the flows in terms of chemical elements, energy content and costs, and of the inventory's overall environmental impact.

In practice this issue can be reasonably addressed as follows:

After modelling the system with all available data, for all missing information a "best approximation" value/flow is to be identified by expert judgment. This relates to all kinds of relevant missing information and data, especially:

- kind and quantity of initially missing flow data,

---

<sup>196</sup> This can be the lower or upper calorific value or - preferably from method perspective, but less practical - the exergy.

- element composition and energy content of all flows that relevantly contribute to the total mass of the flows,
- cost of all goods and services that relevantly contribute to the total production cost and production value
- environmental impact of yet missing background data for consumed goods and services.

Suitable approaches for identifying / quantifying the above are knowledge from sufficiently similar processes, expert judgement, and legal provisions (e.g. emission limits for related processes or industries, while these may be rather reasonable worst case estimates and need additional expert adjustment).

Most problematic are qualitative gaps, i.e. lack of awareness of the occurrence of a flow. For emissions, legal provisions of any kind that aim at reporting, measuring, or reducing such emissions are a suitable means to detect their existence and potential relevance. Also the existence of abatement technologies for certain emissions is a clear indication. Expert judgement based on process understanding is another means, also for qualitative gaps on consumables and services, which might also be detected by their cost but might not be easily attributable to the analysed process as handled e.g. on site level.

Especially for missing environmental impact data, LCI data sets of similar goods or services can be used or average LCI data sets of the group of goods or services to which the respective product or waste flow belongs. If e.g. an unknown "Metal sheet" is used in a furniture manufacturing process of wooden writing desks, a mix of differently coated (e.g. powder, zinc) sheets of the typically used metals for the respective type of product or in that industry (e.g. 70 % steel, 30 % aluminium for writing desks) could be used. If also the amount of that sheet is unknown, the value (of its mass or area and thickness) could be approximated from knowing its function in the product and the products total mass, applying expert judgement (e.g. "connecting elements of wooden writing desks of each 40 kg total mass" could result in the estimate of 1 kg at 2 mm sheet thickness). Similarly a missing inventory for a "production plant for chemical X" would be approximated from similar production processes, scaling the inventory by the relative annual amount of production of the respective chemicals. If such information would be generally missing, an expert judgement of the mass of the main components of the chemical plant (e.g. stainless steel, construction steel, polymers, concrete) and their respective processing depths (e.g. tubes, profiles, precast, foil) could be obtained. Available LCI data sets can then be used to approximate the life cycle inventory of that plant and scale/relate it to its life time output of the analysed chemical.

Note that in contrast to the subsequent step of identifying which flows should be priority for obtaining better quality data, here the most likely value ("best approximation") is to be used.

Note also that in contrast to the data that should stay in the final inventory, for approximating the 100 % value also data of lower quality should be included, as long as their quality is not so low that they very substantially worsen the overall data quality. Note that when later reporting the inventory, the data of lower quality than "data estimate" is to be left out of the inventory, as it would otherwise lower the overall quality of the data set.

Depending on what has been decided in chapter 6.6.3 on whether the overall environmental impact is judged separately and for all of the included impact categories or jointly for all of them by including a normalisation and weighting step, the LCIA results or

weighted LCIA results are calculated. This is the approximated 100 % value of overall environmental impact.

It is argued that along these steps a reasonable approximation of the unknown 100 % value can be achieved, as it is good practice in industry<sup>197</sup>. If in the end, the true but unknown overall environmental impact value can be expected to be a few % higher or sometimes lower<sup>198</sup> than the approximated 100 %. This should however very seldomly affect the validity of the work. This is due to the fact that even for very good and complete studies there are always a few remaining % of data uncertainty and a similar % lack of accuracy. Hence to actually achieve 100.0 % completeness compared to e.g. 97 % would not improve the overall quality of the results or the robustness of decision-support.

To get an idea of how precise is the 100 % approximation, the share of data of different overall quality should be analysed, i.e. which share is of "high quality", "basic quality", and "data estimate": The higher the share of higher quality data is, the more precise is also the 100 % approximation and the more precise is the value that can be given for the achieved overall completeness.

### **Judging the achieved degree of completeness along the operational criteria**

How does that look like in practice: In an example, the final cut-off criteria may be e.g. "90 % of the overall environmental impact". It would then be checked on level of the unit process whether the included flows of at least "data estimate" jointly make up at least 90 % of the unit process' environmentally relevant chemical elements' masses (e.g. of each "Carbon", "Sulphur", and "Nitrogen" for a "Fuel oil heating XY" process), 90 % of the unit process' energy (as lower or upper calorific values of all energy-containing flows), 90 % of the unit process' cost (e.g. production cost including waste treatment cost and production value/market price of all co-products of e.g. a manufacturing process).

Note, that for the chemical elements' mass and energy this refers separately to input and output flows. For costs it relates to the total production cost on the one hand and total production value or market price on the other hand.

The inclusion of specific emissions that might escape the previous steps but that are nevertheless relevant (e.g. among others particle emissions in the above fuel oil heating process, or dioxin emissions for certain scrap melting and waste incineration processes) can mostly be identified by including all legally regulated emissions for that or similar process types or are identified by expert judgement, drawing on know-how for these or similar processes. For these emissions no other, quantitative operational cut-off can be given, i.e.

---

<sup>197</sup> Sometimes it is proposed to use economy wide or industry sector wide inventory data and break these down to single products' inventory data sets. This is meant to overcome the not 100% completeness of the process-based inventories. However, also these sector and economy wide data are not 100% complete. They are based on incomplete data from only a part of the (moreover only bigger) companies plus integrating other information sources. This data is extrapolated for the rest of the entire sector, using various assumptions and expert judgement. Also, the related life cycle model is based mostly on economic relationships among sectors instead of a specific process or supply-chain. This, and the allocation of the impacts across all products from the same sector, results in additional distortions. The resulting inventory data sets from economy or sector wide models can hence not be assumed to be more complete than process-based inventory data sets. In fact, given its method-inherent lack of accuracy and its uncertainty, this data can be expected to strongly overestimate or underestimate the true 100% value, depending on the specific case. It can be concluded that the 100% completeness of the inventory of a single process step can best be approximated by analysing this process step along an approach as described in the main text above. The completeness of the single process steps is then the most accurate basis for the completeness of the product's life cycle model.

<sup>198</sup> It can be lower, if the lack of quality of the data that is used to approximate it, overestimates the 100% value.



their inclusion can be judged only when judging the achieved overall environmental impact, in the next step:

### Completeness of environmental impact

To obtain the interim or finally achieved values of completeness ("cut-off"), the % coverage with data of at least "data estimate" quality is calculated. This uses the approximated 100 % value of the whole system model including data of lower quality as reference (using the "best approximation" information and data for still missing information and data); see above.

### Option to leave out negligible flows

In addition, all processes and flows that can be judged to be quantitatively negligible from former experience or from using "reasonably worst case" approximation, can be entirely left out of the inventory. "Negligible" means here that such processes/flows make up together less than 10 % of the part of the share that is cut off. Example: The cut-off for one example system might be 95 %. E.g. 80 % of the overall results might be of "high quality" and "basic quality" and 15 % might be lower quality "data estimates", using the "best approximation" data. In that example, everything else can be entirely excluded as "negligible" if it together can be approximated / estimated to account for less than 10 % of 5 % (i.e. 0.5 %) of the total impact. This last provision allows to remove all negligible flows from the inventory. This is estimated to result in inventories of LCI results that are reduced by roughly 50 to 80 % of the inventory flows, easing quality control and interpretation. For transparency and communication reasons it is however recommended to leave them in.

### Provisions: 9.3.2 Completeness check

This provision applies to all types of deliverables of the study, but for unit process, partly terminated systems, LCI results and LCIA results data sets as deliverables only to improve the data quality during the iterative loops of developing the LCI data or the system model. (Findings may also be included in an LCI study report.)

- 1) **SHALL - Evaluate LCI model completeness (cut-off):** The cut-off rules as defined in the scope phase (see chapter 6.6.3) shall be systematically applied to ensure that the final data set inventory/ies meets the pre-defined or goal-derived data quality requirements (see chapter 6.9.2). Evaluate the completeness of the inventory data in relation to the initially defined cut-off criteria in terms of:
  - 1.a) **Process coverage:** Coverage of all relevant processes in the system
  - 1.b) **Elementary flow coverage:** Coverage of all relevant elementary flows in the inventories for the processes of the system (and in particular the key processes identified under Significant issues – see chapter 9.2), that have characterisation factors for the relevant impact categories (according to the goal of the LCI/LCA study)
  - 1.c) **Operationalise cut-off approximation:** The cut-off criteria / approach and percentage as defined in the scope phase shall be used (see 6.6.3). This may be operationalised using stepwise the following cut-off rules for flow properties, pre-checking property by property the achieved completeness across all flow types and balancing the aggregated numbers in the inputs against those of the outputs: [ISO+]
    - 1.c.i) **For product flows:** "mass" (of individual key chemical elements), "energy content", "market value" (or "production/provision cost",

especially for purchased services).

- I.c.ii) **For waste flows:** “mass” (of individual key chemical elements), “energy content”, “treatment cost”.
- I.c.iii) **For elementary flows:** “mass” (of individual key chemical elements and only for the environmentally relevant flows, i.e. excluding not or less relevant flows such as e.g. incineration air consumed and waste steam leaving the process as emission to air), “energy content”.
- I.d) **Cut-off for comparative assertions:** The cut-off shall always be met also by mass and energy, in addition to environmental impact.
- I.e) **Additional relevance criteria for elementary and waste flows:** Also those emissions and wastes should be include in the data collection that have a low mass and energy content but a known relevance for the respective type of processes or industry (using e.g. legal limits and expert judgement). [ISO+]
- I.f) **Approximating the 100 % value:** The 100 % reference of completeness may be approximated by using "best approximation" values for all initially missing information and data, using among others information from similar processes and expert judgement. This missing information and data can be especially: [ISO+]
  - I.f.i) kind and quantity of initially missing flows,
  - I.f.ii) element composition and energy content of all flows that relevantly contribute to the total mass of the flows,
  - I.f.iii) cost of all goods and services that relevantly contribute to the total production cost and production value
  - I.f.iv) environmental impact of yet missing background data sets for consumed goods and services.
- I.g) **Estimating precision of 100 % value approximation:** The precision of the 100 % approximation may be judged from analysing the share of the different quality levels of the data that make up the inventory: a higher share of low quality data also makes the 100 % approximation less precise. [ISO+]
- I.h) **Completeness of impact:** As last step, and using the quantitative cut-off value decided upon in chapter 6.6.3, approximate the achieved degree of completeness / cut-off. [ISO+]
- I.i) **Leaving out negligible flows:** It is an option to leave out negligible flows that jointly make up less than 10 % of the share of impact that is cut off (e.g. if the completeness is 95 %, 5 % are cut-off. 10 % of these 5 % are 0.5 % that are considered negligible.) It is recommended however to not leave them out. [ISO+]

Note that the LCIA methods and (potentially) normalisation and weighting for use in defining the cut-off was decided in the scope phase, see chapter 6.7.7.

Note that for unit processes and partly terminated systems the completeness is to be judged in relation to the unit process and partly terminated system itself. I.e. any lack of completeness of other processes that were added exclusively to complete the system model for the completeness check shall be disregarded when quantifying the achieved completeness.

- II) **SHOULD - Improve completeness, if needed:** In the case of insufficient completeness, the inventory analysis (and sometimes the impact assessment) phases should be revisited to increase the degree of completeness. It is recommended to focus

on the key life cycle stages, processes and flows identified as significant issues. This improvement of the LCI data is however to be started by potentially fine-tuning or revising goal and scope, i.e. with a complete iteration (see chapters 2.2.4 and 4, and related Figure 4 and Figure 5).

- III) **SHALL - Report final completeness; potentially revise scope or goal:** If the aimed at completeness has been achieved, or if it cannot be increased further, the finally achieved degree of completeness shall to be reported (as % degree of completeness / cut-off). For LCA studies, it shall be considered when later formulating the limitations in the conclusions and recommendations. If the aimed at or necessary completeness cannot be achieved, it shall be decided whether the scope or even the goal needs to be revised or re-defined.

### 9.3.3 Sensitivity check (of achieved accuracy and precision)

(Refers to ISO 14044:2006 chapter 4.5.3.3 and aspects of 4.4.4)

The sensitivity check has the purpose to assess the reliability of the final results and – if included – of the conclusions and recommendations of the LCA study<sup>199</sup>. Expert judgement and previous experiences contribute to the sensitivity analysis. Scenario analysis and uncertainty calculations are the quantitative methods to support it (see annex 16).

In the interpretation step the sensitivity analysis is used together with information about the uncertainties of significant issues among inventory data, impact assessment data and methodological assumptions and choices to assess the reliability of the final results and the conclusions and recommendations which are based on them (chapter 9.4).

As required under ISO 14044:2006, the evaluation element shall include interpretative statements based on detailed sensitivity analyses when an LCA is intended to be used in comparative assertions intended to be disclosed to the public.

It is useful to structure the sensitivity check along the LCA phases “goal and scope”, “life cycle inventory”, and “life cycle impact assessment”:

#### Goal and scope phase:

- The sensitivity analysis is to check for limitations in the appropriateness of the scope choices, in relation to the goal of the study and for drawing conclusions and recommendations, especially the appropriate...
  - identification of the system(s) to be studied;
  - identification of the function(s) and functional unit of the system or, in the case of comparative studies, the systems;
  - identification of the appropriate LCI modelling frameworks and method approaches to be applied
  - identification of the system boundary and quantification of the cut-off criteria;
  - selection of the included impact categories and applied LCIA methods;
  - identification of the interpretation approach to be used;

<sup>199</sup> Note that ISO 14044 puts the process of verifying whether “... assumptions, methods and data ... are in accordance with the goal and scope definition ...” into the definition of „Consistency check“, while they are (more plausible) applied in the chapter „Sensitivity check“, what is done here as well.

- identification of LCI data and data quality requirements, including the applicability of the inventory data with the selected LCIA methods;
- selection of normalisation and weighting sets<sup>200</sup>, if included as optional elements;
- kind of assumptions and value choices made and their relevance
- identification of applicable limitations to the use and/or interpretation of the results;

Regarding goal and scope issues, the sensitivity check can be done by calculating and comparing scenarios especially for different specific LCI method approaches to solve multifunctionality of processes<sup>201</sup>. For the other items it can be done by qualitative analysis and argumentation based on expert judgement and building on previous experiences.

### Life cycle inventory phase:

- The sensitivity analysis is to check for limitations in the appropriateness of the life cycle inventory work, in relation to the goal and scope of the study and for drawing conclusions and recommendations. This relates especially to the appropriate collection or selection of inventory data regarding ...
  - their technological, geographical and time-related representativeness for the analysed system (especially for “key” processes”);
  - their completeness of the inventory in relation to the included and quantitatively relevant impact categories (especially for “key” processes”);
  - the precision of their inventory values and parameters, due to the stochastic uncertainty of the used raw data

Regarding life cycle inventory issues this check is at least to be done on the sensitive issues that were identified in the preceding step (see chapter 9.2).

The check can be done by joint scenario analysis and/or be accompanied by an uncertainty calculation (e.g. Monte-Carlo Simulation). Note again that uncertainty calculation can support an expert judgement while not substitute it, given the limitations of uncertainty calculations to reflect the true uncertainty. The influence of data uncertainty for key issues can also be checked by allowing the data and parameters to vary within the limits given by the uncertainty estimates while modelling the system and comparing the results.

---

<sup>200</sup> This includes the following: A) If normalisation is included as optional element: Limitations in especially the completeness and consistency across impact indicators but also the geographical and time-related representativeness of the normalisation data. Limitations in the compatibility with the chosen LCIA method and impact categories. Limitations regarding the appropriateness of the selected geographical or other reference of the normalisation data in relationship to the target audience and decision-context of the LCA work. B) If weighting is included as optional element: limitations regarding the chosen weighting level (i.e. midpoint or endpoint level), due to the different degree of precision of the LCIA results and different robustness of the weighting factors. Limitations regarding the appropriateness of the weighting approach (e.g. scientific panel, distance-to-target, policy panel, stakeholder-panel, etc.) in view of the decision-context and target audience of the LCA work results.

<sup>201</sup> This means within the range of the methodological provisions of this document, e.g. in cases where different physical causalities may be applicable as allocation criteria or where different permissible options exist for system expansion / substitution.

**Life cycle impact assessment phase<sup>202</sup>:**

- The sensitivity analysis is to check for limitations in the appropriateness of the LCIA work, in relation to the goal and scope of the study and for drawing conclusions and recommendations. This relates especially to the
  - appropriate selection (or if applicable: development, variation/extension) of the LCIA methods and their correct and complete application to the inventory
  - appropriate selection and correct application of normalisation and weighting factors (if included)
  - achieved precision of the LCIA results, if such are the deliverable of the LCA study or basis for a subsequent interpretation and conclusions drawn.

In relation to the latter, due attention shall be paid in the interpretation to the fact that the uncertainty of the characterisation factors varies between the impact categories reflecting the state of the art in terms of modelling of the underlying impact pathway, and also the availability and quality of substance data applied in calculation of the characterisation factors for individual substances. The chemical-related midpoint level impact categories addressing human toxicity and ecotoxicity are thus accompanied by considerably larger uncertainties than the often energy-conversion related midpoint level categories addressing e.g. acidification, photochemical ozone formation or global warming impacts.

Regarding LCIA, the sensitivity check can be done by a scenario analysis, applying different permissible LCIA methods. This can be accompanied by an uncertainty calculation on LCIA results level. Note that such can only support an expert judgement while not substitute it, given the limitations of uncertainty calculations to reflect the true uncertainty.

Regarding normalisation and weighting as optional elements of the LCIA phase, the sensitivity check can combine scenarios applying different permissible weighting sets (potentially including with uncertainty calculations) on the level of the normalised LCIA results.

**Use of sensitivity analysis during iterative LCI/LCA study**

The combination of sensitivity analysis helps in identifying focus points for improved inventory data collection or impact assessment. Data, which has a strong influence on the final results of the LCI/LCA study may nevertheless not require further data collection effort if the representativeness and completeness of the data is high and its uncertainty low. Also data with a high uncertainty need not be a focus point for improvement if the sensitivity/relevance of this data is very low.

The focus point for improvement of data quality should be data with both a strong influence on the overall results and a high uncertainty (see Figure 26). If such data cannot be improved, the result is a low overall quality of the results which is to be documented. If the precision is insufficient to meet the requirements from the intended application of the results, it may be necessary to revise the goal of the LCI/LCA study.

---

<sup>202</sup> A number of the LCIA-related issues are to be addressed by the developers of the LCIA methods, and documented concisely with the methods as input to the LCA practitioner: A) Limitations in the methodological appropriateness and consistency of the LCIA method in relation to the represented midpoint level impact potential or endpoint damage. B) Limitations in the geographical, time-related and area-of-protection related representativeness of the LCIA method. C) Limitations in the precision of the impact factors, due to the stochastic uncertainty of the used raw data, related to among others substance properties, transport and transfer coefficients, exposure pathway factors, effect factors etc.

The second priority for improvement of data quality is the data that stands in between, i.e. showing both high sensitivity or significance and medium uncertainty or showing both high uncertainty and medium sensitivity.

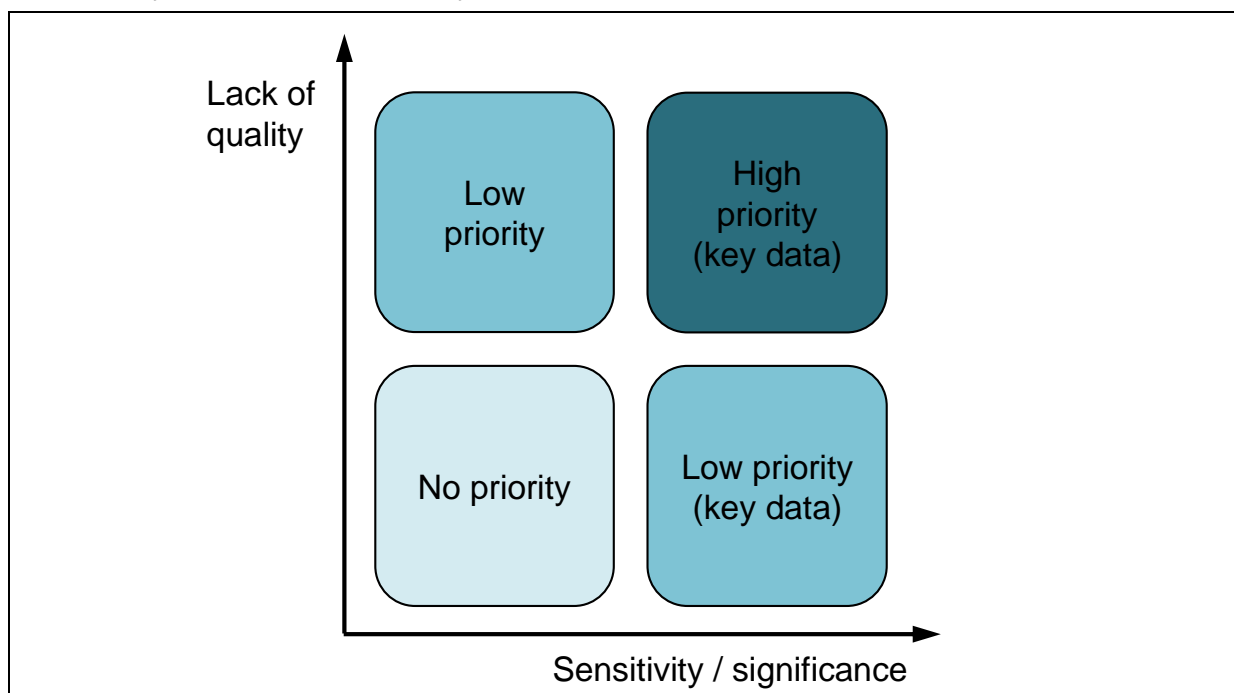

**Figure 26 Focussing efforts on key data.** In the iterative loops, main focus is on the key data with lack of quality (i.e. limited representativeness and consistency, high uncertainty, low completeness) paired with high sensitivity or significance.

Due to the need for an iterative approach in LCA, sensitivity analysis hence used as an integrated element (with a steering function) in the iteration loops incorporating inventory data collection, impact assessment and system boundary setting for the system. The findings from these earlier sensitivity analyses are used as starting point for the sensitivity check of the interpretation.

### Provisions: 9.3.3 Sensitivity check (of accuracy and precision)

This provision applies to all types of deliverables of the study, but for unit process, partly terminated systems, LCI results and LCIA results data sets as deliverables only to improve the data quality during the iterative loops of developing the LCI data or the system model. (Findings may also be included in an LCI study report.)

- 1) **SHALL - Check sensitivity of results:** Check to what extent the accuracy and precision of the overall results meets the requirements posed by the intended applications. Aim at improving it to the required level, as follows:
  - 1.a) **Sensitivity of significant issues:** Identify the most sensitive among the significant issues identified earlier (chapter 9.2) and analyse the sensitivity of these for the overall results, along with their stochastic and systematic uncertainty estimates. The outcome is determining for the accuracy and precision of the overall results and the strength of the conclusions, which can be drawn from the LCI/LCA study and must be reported together with these. Be aware that calculated uncertainty figures may not include the often determining systematic uncertainties caused by model assumptions, data gaps, and lack of accuracy.

- I.a.i) **Sensitivity of LCI items:** Evaluate the sensitivity of the LCIA results (or weighted LCIA results, if applied) to key flows, process parameter settings, flow properties, and other data items such as recyclability, life-time of goods, duration of services steps, and the like. Assess how sensitive inventory items influence the data representativeness, and precision. [ISO!]
- I.a.ii) **Sensitivity of LCIA factors:** Evaluate the sensitivity of the LCIA results (or weighted LCIA results, if applied) considering the often widely differing uncertainty of the results due to uncertainties in the impact assessment (e.g. Human toxicity, Ecotoxicity etc. with high uncertainties and Global warming, Acidification, etc. with lower uncertainty). [ISO!]
- I.a.iii) **Sensitivity of modelling choices and assumptions:** Evaluate the sensitivity of the LCIA results (or weighted LCIA results, if applied) to different modelling choices and method assumptions ("method issues"), e.g. quantitative and qualitative aspects of the functional unit, superseded processes, allocation criteria, etc. [ISO!]
- I.b) **Improve robustness of sensitive issues data, parameters, impact factors, assumptions, etc. as possible:** In the case of lack of quality for some of the significant issues, revisit the inventory analysis and/or the impact assessment phases to improve the concerned data (for data issues), impact factors (for LCIA issues), or try to qualify and discuss the sensitive assumption or choice (for method issues). As for data completeness, also the improvement of the LCI data precision is however to be started by potentially fine-tuning or revising goal and scope, i.e. with a complete iteration (see chapters 2.2.4 and 4).
- I.c) **Report final achievements; potentially revise scope or goal:** If the certainty of key issues meets the needs, or if it cannot be reduced to obtain the accuracy and precision that is required by the application of the LCI/LCA study, it shall be decided whether the scope or even the goal needs to be revised or re-defined. This shall be reported and for LCA studies later be considered when formulating the limitations in the conclusions and recommendations from the LCA (chapter 9.4).

### 9.3.4 Consistency check

(Refers to ISO 14044:2006 chapter 4.5.3.4)

The consistency check is performed to investigate whether the assumptions, methods, and data have been applied consistently throughout the LCI/LCA study<sup>203</sup>. The consistency check applies both to the life cycle of an analysed system and between compared systems.

Methodological issues of relevance are especially the LCI modelling frameworks (i.e. attributional or consequential) and approaches (i.e. allocation criteria and selection of substituted systems), but also setting of system boundaries, extrapolations of data, the consistent application of the impact assessment, and other assumptions.

<sup>203</sup> Note that ISO 14044 puts the process of verifying whether "... assumptions, methods and data ... are in accordance with the goal and scope definition ..." into the definition of „Consistency check“, while they are (more plausible) applied in the chapter „Sensitivity check“, what is done here as well.

Inventory data issues of relevance concern the consistency of the time-related, geographical, and technological representativeness of the data, the appropriateness of the chosen unit process or LCI results to represent processes in the foreground and background system, and the completeness and precision of the data.

Impact assessment issues of relevance are the consistent application of the LCIA elements, including – if applied – normalisation and weighting factors. Regarding the interrelationship of LCI data and LCIA methods this relates to the consistency of spatially and time-related differentiation of inventory data and corresponding impact factors.

### Provisions: 9.3.4 Consistency check

These provisions apply to all types of deliverables of the study, but for unit process data sets as deliverable only to improve the data quality during the iterative loops of developing the LCI data or the system model. (Findings may also be included in an LCI study report.)

For partly terminated systems, LCI results and LCIA results data sets they serve in addition to ensure method consistency across the processes of the model.

For LCA studies, they serve in addition to ensure method consistency across the models of the compared systems.

- I) **SHALL - Data quality sufficiently consistent?:** Check whether any differences in data quality *per se* (i.e. accuracy, completeness, and precision) and in the selected data sources for the different processes in the system(s) are consistent with the goal and scope of the study. This is especially relevant for comparative studies.
- II) **SHALL - Method choices consistent?:** Check whether all methodological choices (e.g. LCI modelling principles, allocation criteria or system expansion / substitution approach, system boundary, etc.) are consistent with the goal and scope of the study including the intended applications and target audience. This shall be judged by checking whether the method provisions have been met that are given in relation to the applicable Situation A, B, or C1 / C2. [ISO!]  
  
Note that method consistency applies on both unit process level (i.e. consistent approach to develop unit process from raw data) and system level (i.e. consistently modelling the system). This aspect is especially relevant when combining data from different sources.
- III) **SHALL - Consistent impact assessment?:** Check whether the steps of impact assessment (including normalisation and weighting, if included) have been consistently applied and in line with goal and scope.
- IV) **SHALL - Evaluate relevance of inconsistencies:** Evaluate the relevance / significance of any identified inconsistencies (as above) for the results and document them, including when reporting the achieved method consistency and appropriateness. For LCA studies additionally consider these findings when drawing conclusions or recommendations from the results.

## 9.4 Conclusions, limitations, and recommendations

(Refers to ISO 14044:2006 chapter 4.5.4)

### Overview

Integrating the outcome of the other elements of the interpretation phase, and drawing on the main findings from the earlier phases of the LCA, the final element of the interpretation is to draw conclusions and identify limitations of the LCA, and to develop recommendations for



the intended audience in accordance with the goal definition and the intended applications of the results.

### **Drawing conclusions**

The conclusions should be drawn in an iterative way: Based on the identification of significant issues (chapter 9.2) and the evaluation of these for completeness, sensitivity and consistency (chapter 9.3), preliminary conclusions can be drawn. Conclusions say whether the questions that were posed in the formulation of the goal definition can be answered by the LCA, i.e. whether significant differences exist between alternatives, which role the various sensitive issues play for such differences, and the like. An example e.g. for the illustrative goal question: “which of the two selected cleaning solutions for X has the lower environmental impacts” as the starting point of a comparative study of cleaning X by machine vs. cleaning X by hand it might be concluded: significant differences exist, but only for some of the relevant scenarios of user behaviour for manual cleaning and the energy-efficiency of the cleaning machine. The main factors of manual cleaning are the used water temperature and amount (depending on how often water is exchanged and whether final rinsing is done with running water).

It is then checked whether the preliminary conclusions are in accordance with the requirements and limitations of the goal and scope phase, the limitations of the life cycle inventory phase and the limitations of the life cycle impact assessment phase.

The most frequently outstanding limitations of being able to draw significant conclusions (where such would in theory be possible, as real differences exist) are:

- the system boundary / cut-off settings (and that they have been actually met by the LCI data and model),
- the achieved LCI data quality and consistency, as required by the goal,
- the uncertainty of the LCIA methods,
- specific predefined assumptions of the goal phase,
- and for the given case relevant other, specific methodological and study limitations.

If the conclusions are consistent with the requirements, they can be reported as final conclusions, otherwise they must be re-formulated and checked again.

### **Dealing with limitations**

Any limitations of the study within the given goal and scope of the LCA study must be listed. Such can be e.g. a limited completeness of elementary flows with relevance to relevant impact categories, or a limited time-representativeness, or pre-selection of climate change impacts only for carbon footprint studies, or methodological inconsistencies such as e.g. between some of the background data with the rest of the system, etc.

It is then to be evaluated for each of them the type and magnitude of consequences these have for the conclusions and intended applications.

### **Interpretation for comparative studies**

In studies that involve a comparison of systems (whether disclosed to the public or not), the interpretation has to consider a few additional points to ensure fair and relevant conclusions from the study:

- Significant issues must be determined for each of the systems, and special attention is to be given to issues that differ between the systems and that have the potential to

change the conclusions of the comparison. Such differences need to be eliminated if possible or otherwise fully considered in the formulation of conclusions.

- If an uncertainty analysis is performed to investigate whether the difference between two systems is statistically significant, the analysis should be performed on the difference between the systems (i.e. one system minus the other), taking into account potential co-variance between processes of the two systems (e.g. processes which are the same) as far as possible given confidentiality restrictions regarding the access to included processes.
- The important consistency check addresses consistent treatment of the key issues in the different systems and is fundamental to ensure a fair comparison:
  - Are the compared systems sufficiently equivalent?
  - Are differences in the quality of inventory data between different systems acceptably small, considering the relative importance of the processes in the system, and are the differences consistent with the goal and scope of the study? (If e.g. one study is based on specific and recent data with a high degree of representativeness for all the key processes while the other uses extrapolation from literature data, there is a bias in the inventory data which can make a comparison invalid.)
  - Have the LCI modelling frameworks, allocation rules and system boundary setting been consistently applied to all compared systems (including in the background data)?
  - Has the impact assessment been performed consistently for the systems, have the relevant impact categories been included for all systems, and have the impacts been calculated in the same way and with the same degree of completeness of elementary flows for all the systems?

These are very important issues, and if they differ substantially between the systems, it can strongly bias the comparison and easily make it invalid.

When an LCA is intended to be used in comparative assertions intended to be disclosed to the public, the ISO 14044:2006 standard requires in addition that the evaluation element includes interpretative statements based on careful sensitivity analyses. It is emphasized in the standard, that the inability of a sensitivity check to find significant differences between different studied alternatives does not automatically lead to the conclusion that such differences do not exist, but rather that the study is not able to show them in a significant way.

At the same time, insignificant differences should be taken as what they are: insignificant; there is not always a clear preference for one or the other system, and this is also a valid outcome of an LCA study.

### **Deriving recommendations**

Recommendations based on the final conclusions of the LCA study must be logical and be reasonable and plausible founded in the conclusions and strictly relate to the intended applications as defined in the goal of the study.

Recommendations can be (always relating to the goal of the study) e.g.:

- to focus product improvement on one or more specific process(es) or specific emission(s) that contribute main shares to the overall impact and have a relevant potential for improvement<sup>204</sup>,
- on the superiority of one product over others that quantitatively and qualitatively fulfil sufficiently equivalent function(s), or
- the lack of significant differences among a group of products that fulfil the same functions,
- to change a supplier towards a supplier with less impacting own production or supply-chain<sup>205</sup>,
- to improve the user manual by advising product users of how to easily lower the overall environmental impacts of the analysed product,
- to stimulate the development of certain technology families (or raw material bases, etc.) by political or tax measures or R&D investment,
- etc.

Note that other applications beyond the ones covered in this guidance document (e.g. identifying ecolabel criteria or ecodesign indicators) may require additional steps, drawing on the deliverables of the LCA potentially including any conclusions and recommendations.

#### **Frequent errors: Inappropriate results interpretation in case of insignificant differences**

There are two, opposite risks when finding that compared alternative products do not differ significantly:

- Firstly, a over-interpretation of the result:
  - exaggerating small or insignificant differences
  - drawing general conclusions and recommendations from specific case studies
  - putting to high confidence on differences between compared systems based on results of uncertainty analysis alone, that are only partially cover the full uncertainty of the results and do not include their accuracy.
- Secondly, the risk of inappropriately claiming equality of compared alternatives, based on unbalanced or poor quality data that result in insignificance of differences. To avoid this, the reason for insignificance of differences between compared systems is to be stated together with the outcome of the study. An imbalance in the available data, methods applied etc. cannot be used to conclude that no difference exist between the two compared systems. The same applies analogously if the data situation is balanced by for both systems but at a low data quality level.

<sup>204</sup> Note that such „product internal comparisons“ are formally also product comparisons and – especially in case of publication – the additional requirements for comparative assertions disclosed to the public are to be met also here.

<sup>205</sup> Note that this touches on the issue of attributional and consequential modelling.

## Comparative studies on not objectively comparable alternatives

As explained in chapter 6.10.3, comparative studies may be performed on systems where the comparability cannot be done objectively (other than e.g. for bulk chemicals) but is to be judged by the individual consumer (e.g. for many personal services).

The results and recommendations of such comparative studies shall hence be presented with the explicit statement that comparability is not assumed per se, but lies with the individual preference and judgement.

## Avoiding misinterpretation

To avoid misinterpretations by the target audience any relevant limitations are to be given jointly with the recommendations. It must be avoided as far as possible that the recommendations can be misinterpreted by the addressees of the LCA study beyond the scope of the specific LCA study and beyond what is supported by the outcome of the LCA including accounting for any limitations. This includes that an eventual limited technical or methodological understanding of the addressees must be accounted for. A compilation of aspects to avoid misleading interpretation is given in annex 15.3.

### Provisions: 9.4 Conclusions, limitations, and recommendations

Note the limitations for Situation C1 and C2 studies in their use for direct decision support.

These provisions apply only to comparative and non-comparative LCA studies.

- I) **SHALL - Analyse the results from a system's perspective:** Separately analyse and jointly discuss the results obtained in the main system(s) model(s) and - if performed - with the corresponding reasonably worst and best case assumption scenarios and possibly further assumption scenarios. Integrate the results of any potentially performed uncertainty calculations into the analysis. [ISO!]
  - I.a) **Items that require special or separate analysis:**
    - I.a.i) **Non-generic LCIA:** Separately analyse and jointly discuss the results obtained with the default LCIA methods and those obtained including any potential additional or modified / non-generic (e.g. spatially or otherwise differentiated) LCIA methods.
    - I.a.ii) **Long-term emissions:** Separately analyse and jointly discuss the results for interventions within the first 100 years from the time of the study and those beyond that time limit.
    - I.a.iii) **Carbon storage and delayed emissions:** Only if such is included in line with an explicit goal requirement: Separately analyse and jointly discuss the results including and excluding carbon storage and delayed emissions / reuse/recycling/reuse credits.
  - I.b) **Draw conclusions, if foreseen:** Take into account the findings of the earlier elements of the interpretation phase. Draw conclusions in accordance with the goal defined for the LCA study and with the definitions of the scope, in particular those related to data quality requirements, and with the predefined assumptions and known limitations in the methodology and its application in the LCA. Consider all assumptions and related limitations that were noted down in the course of the study.
  - I.c) **Address impacts outside the LCA scope, if any:** Name any potential or actual

effects on the three areas of protection that are based on other mechanisms than those covered by LCA (e.g. accidents, direct application of products to humans, etc.) and that are considered relevant by the interested parties. Clarify that these are outside the scope of LCA.

Note that within the ILCD Handbook, not quantified effects outside the scope of LCA cannot be explicitly or implicitly assessed regarding their relevance in comparison to the LCA results<sup>206</sup>.

I.d) **Conclusions for comparisons:** Differences in data quality and methodological choices between compared systems shall be consistent with the goal and scope of the study, especially (see also chapter 6.10):

I.d.i) The functional unit of the compared alternatives shall be sufficiently similar to allow for comparisons, especially in view of stakeholders and potential users.

I.d.ii) The setting of system boundaries shall be consistently applied to all systems.

I.d.iii) The inventory data should be of comparable quality (i.e. accuracy, completeness, precision, methodological consistency) for all compared alternatives.

I.d.iv) The steps of impact assessment shall be consistently applied for all systems.

I.d.v) The significance of any above identified inconsistencies to the results of the comparison shall be evaluated and considered when drawing conclusions and giving recommendations from the results.

II) **SHALL - Recommend strictly based on conclusions and limitations:**

II.a) Base any recommendations made in the LCA study exclusively on these conclusions and respecting the limitations. Derive recommendations unambiguously and in a stepwise logical and reasonable consequence of the conclusions. Do so in accordance with the defined goal of the LCA study and specially the intended applications and target audience.

II.b) Recommendations shall be made in a conservative way, only based on significant findings. Any relevant limitations found during the study are to be stated explicitly and clearly in the key message of the LCA study including in the executive summary. [ISO!]

II.c) Special care must be taken to avoid misinterpretations also by a non-technical audience, to avoid interpretation beyond the scope of the LCA study and beyond what is supported by its outcome.

II.d) Equality of compared alternatives shall not be stated, unless it has been shown to be significant: the lack of significant differences alone shall not be misinterpreted as equality of the analysed options. It shall only be stated that with the given data restrictions and/or uncertainties or other causes no significant differences could be identified. [ISO!]

<sup>206</sup> Effects outside the scope of LCA may be - if available and quantified in a comparable manner (e.g. quantitatively related to the functional unit, considering the whole life cycle etc.) - integrated with LCA results in an additional evaluation and report beyond the scope of LCA and outside the scope of the ILCD. This should consider the relative accuracy and precision of the different approaches and effects.

- III) **SHALL - Comparisons of systems with dominant subjective preference:** The results and recommendations of comparative studies on not objectively comparable alternatives (e.g. personal services, fashion items, jewellery) shall be presented with the explicit statement that comparability is not assumed per se, but lies with the individual preference and judgement. [ISO!]
- IV) **SHALL - Conclusions on basket-of-product type of studies:** For studies that analyse several processes or systems in a non-competitive manner, i.e. processes / systems that perform clearly different functions (e.g. basket-of-products, identifying priority products) it shall be clearly reported that no comparability exists in terms of preferability among the processes / systems.

Note: Annex 15.3 gives an illustrative example on avoiding misleading goal and scope definition and results interpretation for comparative studies.

# 10 Reporting

(Refers to ISO 14044:2006 chapter 5)

## 10.1 Introduction and overview

The results and conclusions of the LCI/LCA study shall be completely and accurately reported without bias to the intended audience. The results, data, methods, assumptions and limitations shall be transparent and presented in sufficient detail to allow the reader to comprehend the complexities and trade-offs inherent in the LCA. The report shall also allow the results and interpretation to be used in a manner consistent with the goals of the study.

The needs of different audiences should be recognized and addressed when presenting or disseminating the study. Target audiences can be internal, (defined) external, or public, and technical or non-technical. These audiences can include companies, trade associations, government agencies, environmental groups, scientific/technical communities, and other non-government organizations, as well as the general public / consumers. Communication in the public domain is especially critical because the risks of misinterpretation are heightened when LCA-derived information is provided to audiences not familiar with the complexity of the methodology and related limitations that may apply.

Good reporting of LCI and LCA studies provides the relevant project details, the process followed, approaches and methods applied, and results produced. This is essential to ensure reproducibility of the results and to provide the required information to reviewers to judge the quality of the results and appropriateness of conclusions and recommendations (if included).

The complete reporting should also contain the data used and should ensure transparency and consistency of all the methodologies and data employed. It should constitute the primary input to the scientific/technical audience and be a base from which summary reports to other target audiences could be prepared. These latter summaries need to be tailored to the recipient requirements, labelled as summaries only, and include appropriate reference to the primary report and related review reports in order to ensure that they are not taken out of context.

Confidentiality interests around sensitive or proprietary information and data are to be met, while confidential access to at least the reviewers is to be granted to support the review of the data set and/or report. Separate, complementary confidential reports can serve this purpose.

## 10.2 Reporting principles

(Refers to ISO 14044:2006 chapter 5.1.1)

### Reports and data sets

The form and levels of reporting depends primarily on three factors:

- the type of deliverable(s) of the study,
- the purpose and intended applications of the study and report, and
- the intended target audience (especially technical or non-technical and internal or third-party/public).

## Reporting LCIA results

Wherever LCIA results are published in a report or data set, for transparency reasons this is to be accompanied by the LCI results. In the case of normalised or weighted LCIA results, the results of previous steps (classification and characterisation) are equally to be reported. For the same reason, characterisation results at endpoint (damage) level are to be supplemented by midpoint level impact category results, as well as the LCI results.

## Confidentiality

In the case data or information (e.g. on technologies, catalysts, ingredients) cannot be reported for confidentiality or proprietary reasons, this information can be documented in a separate confidential report that does not need to be made available externally, except for foreseen critical reviewers under confidentiality. The kind of information documented in this confidential report shall be named in the detailed report, if any.

## Reporting of revised goal and /or scope items

In some cases, the goal and the scope of the LCI/LCA study may need to be revised due to unforeseen limitations, constraints or as a result of additional information. The final documentation of the LCI/LCA study has to reflect this, including the consequence for completeness, precision, application fields, etc.

### Provisions: 10.2 Reporting principles

Fully applicable to all types of deliverables, implicitly differentiated.

- I) **SHALL - Report complete and unbiased:** Results and conclusions of the LCI or LCA study shall be completely and accurately reported without bias to the intended audience.
- II) **SHALL - Use SI units:** Per default the *Système international d'unités* (SI) units shall be used for reporting.
- III) **SHALL - Reproducibility and target audience to guide reporting:** Results, data, methods, assumptions and limitations shall be transparent and presented in sufficient detail to allow the reader to comprehend the complexities and trade-offs inherent in the study and LCA in general. Reporting of technical details shall be guided along the aim to ensure an as good as possible reproducibility of the results and of any conclusions and recommendations (if included). (On reporting of confidential or proprietary information see more below). Consider the technical and LCA methodology understanding of the target audience.
- IV) **SHALL - Reporting LCIA results:** Depending on the intended applications, the LCIA results may also be reported in the study report or data set. If done, this shall meet the following requirements: [ISO!]
  - IV.a) The intended way of reporting LCIA results was identified in the scope definition in accordance with the intended application of the LCI/LCA study and any prescription given in the goal definition.
  - IV.b) For transparency reasons, the LCIA results shall be published jointly with the LCI results. In the case of normalised or weighted LCIA results the previous steps (classification and characterisation) shall equally be reported.
  - IV.c) Impact assessment results at endpoint (damage) level shall be supplemented by



midpoint level impact category results (unless the endpoint LCIA method does not have a midpoint interim step) and also by the LCI results.

Note that if the study is intended to support a comparative assertion to be disclosed to the public, no form of numerical, value-based weighting of the indicator results is permitted.

## 10.3 Three levels of reporting requirements

(Refers to ISO 14044:2006 chapters 5.1.2, 5.2, and 5.3)

In accordance with the ISO 14044:2006 standard, this handbook operates with three levels of the classical reporting with different (increasing) requirements. These relate to both project reports and data set files.

### 10.3.1 Report for internal use

(No corresponding ISO 14044:2006 chapter)

The report is for internal use only and not intended for disclosure to any external party outside the company or institution that has commissioned or (co)financed the study or performed the LCA work. Examples could be studies for identification of internal improvement potentials and focus points in product development.

No formal provisions are made for internal reports, of course. In order to provide appropriate and robust decision support, it is recommended to closely orient to the reporting requirements for third-party reports.

### 10.3.2 Third party report

(Refers to ISO 14044:2006 chapters 5.1.2 and 5.2)

The report is intended to document and/or communicate the results of the LCA to a third party (i.e. an interested party other than the commissioner or the LCA practitioner performing the study). Regardless of the form of communication, a third-party report must be prepared as a reference document and documentation of the study.

It is not required to include confidential information that however needs to be available for reviewers under confidentiality agreement, and would be documented separately or as part of the report for internal use.

The detailed aspects that shall be covered in the third-party report (and/or the confidential report as described more above and if such is prepared) are provided in the "Provisions" of this chapter and are not repeated here.

Third-party reports should have an Executive summary for non-technical audience.

For LCI data sets, a well documented, ILCD formatted data set can be the third-party report, if completed with the relevant background documents (e.g. more extensive method reports such as the ILCD Handbook, reports on data collection procedures, data sources used, review report(s), applied LCIA methods and to normalisation and weighting sets, and others, as needed to meet the requirements listed above).

The annex serves to document elements that would inappropriately interrupt the reading flow of the main part of the report, and are also of a more detailed or tabular technical nature and for reference. It should include:

- Questionnaire/ data collection template and raw data

- List of all assumptions<sup>207</sup> (It is recommended that these include those assumptions that have been shown to be irrelevant).
- Full LCI results

### 10.3.3 Report on comparative studies to be disclosed to the public

(Refers to ISO 14044:2006 chapter 5.3)

The study involves a comparison of products and the results are intended to be disclosed to the public. This may or may not involve concluding the superiority of one product (or equality of the analysed products), i.e. it can be a “comparative assertion disclosed to the public” or a non-assertive comparative study that shall be treated the same as a comparative assertion.).

In addition to the third party report, additional requirements apply. Note that it shall include an Executive summary for non-technical audience. The detailed aspects that shall be covered in the reports on comparative, published studies (and/or the confidential report as described more above and if such is prepared) are provided in the "Provisions" of this chapter and are not repeated here.

### 10.3.4 Reporting elements

#### Overview

As initial orientation (next to the exact list of reporting items and the separate LCA study report template) this chapter describes the content of the main reporting elements in an overview. After the practitioner has done the LCA study along the provisions and action points of the ILCD guidance document, he/she also needs to appropriately document this work.

Such a detailed LCA report consist of at least four parts: the Main part, which is additionally condensed into a Technical Summary and an Executive Summary, and an Annex that documents e.g. assumptions and used data (which can also be referenced). Confidential and proprietary information can be documented in a fifth element, a complementary Confidential report. Review reports are either annexed as well or referenced.

The following text describes the general scope and purpose of the different report parts, details are given in the "Provisions" and the reporting template.

This guidance document comes along with electronic templates for LCA reports (i.e. provide a chapter-structure and direct references to the reporting items), which should be used.

For process data sets (i.e. parameterised and not parameterised unit processes, LCI results, partly terminated systems; and optionally including LCIA results), the ILCD reference format is provided as electronic LCI data set format. It should be used for LCI data sets provided together with LCA reports to ensure appropriate and complete documentation and IT compatibility for error-free electronic data exchange.

---

<sup>207</sup> Note that the important ones are to be repeated and considered quantitatively in the sensitivity analysis and quantitatively and qualitatively in the interpretation. The relevant assumptions are also to be documented in the context where they belong, e.g. for processes together with the processes they concern at the relevant place (LCI chapter or scope definition)

### **First element: Executive Summary**

For non-technical audience.

The summary shall be able to stand alone without compromising the results and conclusions / recommendations (if included) of the LCA. The target audience of the executive summary typically will be decision-makers, who may not have time or technical background for reading the detailed report.

The executive summary shall as a minimum include key elements of goal and scope of the system studied. The main results from the inventory and impact assessment components shall be presented in a manner to ensure the proper use of the information, and relevant statements about data quality, assumptions and value judgments should be included.

Finally, the executive summary report should state any recommendations made and conclusions drawn and shall give any limitations that may apply.

### **Second element: Technical Summary**

For technical audience / LCA practitioners.

This summary should be able to stand alone without compromising the results of the LCA. The target audience of the report typically will be technical audiences, who may not have time for reading the full report or use it for getting an overview first. The technical summary should therefore also fulfil the same criteria about transparency, consistency, etc. as the detailed report.

The technical summary shall as a minimum include the goal, the scope, with relevant limitations and assumptions, and an overall flow diagram of the system studied, and shall clearly indicate what has been achieved by the study. The main results from the inventory and impact assessment components shall be presented in a manner to ensure the proper use of the information, and statements about data quality and value judgments shall be included.

Finally, the technical summary shall name any recommendations made and conclusions drawn by the practitioner of the LCA.

### **Third element: Main part**

For LCA practitioners.

- Goal of the study: The reporting of any LCA shall include a clear and concise statement of the following 6 aspects:
  - Intended application(s)
  - Method or impact limitations (e.g. Carbon footprinting)
  - Reasons for carrying out the LCI/LCA study and decision-context
  - Target audience
  - Comparative assertions to be disclosed to the public
  - Commissioner of the LCI/LCA study
- Scope of the study

The Scope chapter shall identify the analysed system in detail and address the overall approach used to establish the system boundaries. The system boundary determines which life cycle stages and process steps are included in the LCA and which have been left out. The scope chapter should also address data quality requirements/ambitions. Finally the scope chapter includes a description of the

method applied for assessing potential environmental impacts and which impact categories, LCIA methods, normalisation and weighting sets are included. Below is the list of information that shall be report in scope chapter:

- Types of final LCA deliverables and intended applications
- Function, functional unit, and reference flow
- System boundaries and cut-off criteria (completeness) plus system boundaries diagram

Full analysis of all operations in a system may be extremely difficult and complex. Therefore, the system boundaries should be made clear to any reader. The reason and potential significance for any exclusion should be provided.

- Methodology (LCI modelling framework and handling of multifunctional processes)

A full description of the methodology used for a particular LCA needs to be presented. It is recognized that the methodologies contain assumptions, all of which may influence the overall results. The report shall explicitly identify all assumptions and value judgments and provide a basis for these assumptions.

- Data representativeness and appropriateness of LCI data & Types and sources of required data and information

The data used in LCAs come from a wide range of sources, which can be of differing quality, variability, and uncertainty. All such issues should be addressed in the report. Data can be gathered from public and private sources. Any such data used in a public study but not disclosed shall be clearly noted. The sources of all public data (for example, specifically referenced textbooks, government reports, or previous LCAs) shall be clearly identified. When used, public data should be included in the report. To prevent losing information by the way data are presented, the same level of detail used in collection should be maintained in reporting.

- Impact assessment methods and factors, normalisation basis and weighting set
- Comparisons between (product) systems

- Collecting inventory (LCI) data, modelling the system, calculating LCI results

The 'Inventory' phase involves data collection and modelling of the system, as well as description and verification of data.

This encompasses all data related to environmental (e.g. CO<sub>2</sub> emissions) and technical (e.g. consumed intermediate chemicals) quantities for all relevant unit processes within the system boundaries that compose the analysed system. Examples of inputs and outputs quantities include inputs of materials, energy, chemicals and 'other' - and outputs of air emissions, water emissions or solid waste. Other types of exchanges or interventions such as radiation or land use should also be included.

The data must be related to the reference flow(s) and/or functional unit(s) defined in the scope chapter. Data can be presented in tables and some interpretations can be made already at this stage. The results of the inventory is an LCI which provides information about all inputs and outputs in the form of elementary flows to and from the environment from all the unit processes involved in the study. Below is list of information which shall be report in this part:

- Flow Diagram

The flow diagram(s) should clearly describe the foreground system and links to the background system, and all major inputs and outputs. Several flow diagrams in different levels of detail may be required to adequately describe the system. The link between the flow diagram(s) and the data should be clearly evident to the reader.

- Describing/documenting unit process data collected for the foreground system
- Calculated LCI results
- Calculating Life Cycle Impact Assessment results (LCIA results)
  - The practitioner needs to document the LCIA results, applying the selected LCIA method and factors, as well - if included for reporting purposes - of the normalised and of the normalised and weighted LCIA results.

- Interpretation
  - Significant issues
  - Completeness check
  - Sensitivity check (of achieved accuracy and precision)
  - Consistency check
  - Conclusions

Any conclusions drawn from the study shall be explicit. They shall be limited to the materials or processes actually examined, appropriate to the variability of the data used in the analyses, and wholly based on the results and methodologies presented in the report.

The conclusions should be honest and unbiased, and cover the whole study.

- Recommendations

Recommendations derived from the conclusions involve interpretations and are thus subjective. Ideally, they should be based solely on the conclusions of the study and incorporate an explicit explanation of the subjective process which form the bases upon which they are founded. The inclusion, and extent, of any recommendations will be determined by the target audience of the LCA.

#### **Fourth element: Annex**

For LCA practitioners.

The annex serves to document elements that would inappropriately interrupt the reading flow of the main part of the report and are also of a more technical nature for reference. It should include:

- Questionnaire/ data collection template and raw data
- List of all assumptions

This should include those assumptions that have been shown to be irrelevant). The important ones are to be considered quantitatively in the sensitivity analysis and quantitatively and qualitatively in the interpretation.

The relevant assumptions are also to be documented in the context where they belong, e.g. for processes together with the processes they concern at the relevant place (LCI chapter or scope definition)

- Full LCI results

### Fifth element: Confidential report

The confidential report shall contain all those data and information that is confidential or proprietary and cannot be made externally available. It shall be made available to the critical reviewers under confidentiality.

#### Provisions: 10.3 Three levels of reporting requirements

Fully applicable to all types of deliverables, implicitly differentiated.

- I) **SHALL** - The following form and level of reporting shall be done:
  - I.a) The required level of reporting was identified in chapter 6.12. [ISO+]
  - I.b) **Use ILCD report template and data set format:** The ILCD report template and the ILCD data set format should be used for reporting LCI/LCA studies and data sets, respectively. [ISO+]
  - I.c) **Enclose / reference report to data sets:** It is recommended to accompany data sets with a LCI/LCA study report.
  - I.d) **Enclose / reference LCI data sets in report:** It is recommended to enclose the modelled LCI data sets to the LCA study report (e.g. as printout and/or via hyperlinks) as far as confidentiality concerns and ownership rights permit this. The full LCI results shall be included in this report.
  - I.e) **Use / combine correct level(s) of reporting:** These specific levels go back to the three main levels of reporting that have a different set of requirements under ISO 14044:2006 that shall be used: “Reports for internal use”, “Third-party report”, “Report on comparative studies to be disclosed to the public”. In detail:
  - I.f) **MAY - Reports for internal use** (recommendation only) (10.3.1): [ISO+]
    - I.f.i) Document results and conclusions of the LCA in a complete, accurate and unbiased way.
    - I.f.ii) Especially regarding inventory data, it is recommended to document the data on the level that it enters the calculations before its unit or property conversion, scaling, etc. (i.e. as “raw data”) to provide appropriate information for reviewers and users. This information may be provided together with calculations such as conversions, scaling factors applied, averaging, extrapolations, etc.
    - I.f.iii) Consider to address some of the requirements to third-party reports or public reports also in internal reports as this will strengthen the robustness and hence reliability of the results.
  - I.g) **SHALL - Third-party reports** (10.3.2): The third-party report is a reference document for any third party to whom the communication is made. The report can be based on confidential information, while this information itself does not need to be included in the third-party report. It is recommended to meet confidentiality interests by making sensitive and proprietary data and information available only to the critical reviewers under confidentiality as a separate confidential report. [ISO+]
  - I.h) In addition to the requirements on reports for internal use, the following

### Provisions: 10.3 Three levels of reporting requirements

components and aspects shall be included in the third-party report<sup>208</sup>: [ISO!]

- II) SHALL - **Executive summary** (for non-technical audience) [ISO+]
- III) SHALL - **Technical summary** (for technical audience / LCA experts) [ISO+]
- IV) SHALL - **Main report**, with the following aspects:

Note that the following items and the [ISO+] and [ISO!] marks do relate to the general structuring and items to be included only; the exact items to be reported are identified in the other Provisions of this document.

#### IV.a) *General aspects:*

IV.a.i) *date of report;*

IV.a.ii) *statement that the study has been conducted according to the requirements of ISO 14044:2006 and the ILCD Handbook. [ISO!]*

#### IV.b) *Goal of the study:*

IV.b.i) *intended application(s);*

IV.b.ii) *method, assumptions or impact coverage related limitations; [ISO!]*

IV.b.iii) *reasons for carrying out the study and decision-context;*

IV.b.iv) *the target audiences;*

IV.b.v) *statement as to whether the study intends to support comparative assertions intended to be disclosed to the public*

IV.b.vi) *commissioner of the study and other influential actors, including LCA practitioner (internal or external). [ISO+]*

#### IV.c) *Scope of the study:*

IV.c.i) *function, including*

IV.c.i.1) *statement of performance characteristics, and*

IV.c.i.2) *any omission of additional functions in comparisons;*

IV.c.ii) *functional unit(s), including*

IV.c.ii.1) *consistency with goal and scope,*

IV.c.ii.2) *definition,*

IV.c.ii.3) *result of performance measurement;*

IV.c.iii) *reference flow(s)*

IV.c.iv) *LCI modelling framework applied, i.e. according to Situation A, B, or C, including [ISO!]*

IV.c.iv.1) *uniform application of the procedures*

IV.c.v) *system boundary, including*

IV.c.v.1) *types of inputs and outputs of the system as elementary flows*

<sup>208</sup> The parts in italics are directly taken from ISO 14044, chapter 5.2, but removing ISO-internal chapter-references. A few aspects have been moved to other places, but all are covered.

### Provisions: 10.3 Three levels of reporting requirements

should be provided,

- IV.c.v.2) decision criteria on system boundary definition, and on individual or systematic inclusions and exclusions [ISO!]*
- IV.c.v.3) omissions of life cycle stages, activity types, processes, or flows,*
- IV.c.v.4) quantification of energy and material inputs and outputs, and*
- IV.c.v.5) assumptions about electricity production;*
- IV.c.vi) cut-off criteria for initial inclusion of inputs and output, including*
  - IV.c.vi.1) description of cut-off criteria and assumptions,*
  - IV.c.vi.2) effect of selection on results,*
  - IV.c.vi.3) inclusion of mass, energy and environmental cut-off criteria.*
- IV.c.vii) data quality requirements should be included (in addition to the finally achieved quality)*
- IV.c.viii) LCIA scope settings, including*
  - IV.c.viii.1) impact categories and category indicators considered, including a rationale for their selection and a reference to their source;*
  - IV.c.viii.2) descriptions of or reference to all characterization models, characterization factors and methods used, including all assumptions and limitations;*
  - IV.c.viii.3) any differentiations, additions or modifications of original, default LCIA method with justifications [ISO!]*
  - IV.c.viii.4) descriptions of or reference to all value-choices used in relation to impact categories, characterization models, characterization factors, normalization, grouping, weighting and, elsewhere in the LCIA, a justification for their use and their influence on the results, conclusions and recommendations;*
  - IV.c.viii.5) a statement that the LCIA results are relative expressions and do not predict impacts on category endpoints, the exceeding of thresholds, safety margins or risks. and, when included as a part of the LCA, also*
  - IV.c.viii.6) a description and justification of the definition and description of any new impact categories, category indicators or characterization models used for the LCIA,*
  - IV.c.viii.7) a statement and justification of any grouping of the impact categories,*
  - IV.c.viii.8) any further procedures that transform the indicator results and a justification of the selected references, weighting factors, etc.,*
- IV.c.ix) included comparison between (product) systems*
- IV.c.x) modifications of the initial scope together with their justification should be*



### Provisions: 10.3 Three levels of reporting requirements

provided

#### IV.d) Life cycle inventory analysis:

IV.d.i) data collection procedures;

IV.d.ii) qualitative and quantitative description of unit processes, at least of the foreground system; [ISO!]

IV.d.iii) references of all publicly accessible data sources (sources for all data used and individual identification for the key processes / systems); [ISO!]

IV.d.iv) calculation procedures (preferably including the steps from raw data to foreground system unit process(es)); [ISO!]

IV.d.v) validation of data, including

IV.d.v.1) data quality assessment, and

IV.d.v.2) treatment of missing data;

IV.d.vi) sensitivity analysis for refining the system boundary;

IV.d.vii) specific substitution or allocation procedures for key multifunctional processes (and products in case the study directly compares multifunctional products), including [ISO!]

IV.d.vii.1) justification of the specific procedures

#### IV.e) Life cycle impact assessment results calculation, where applicable:

IV.e.i) the LCIA procedures, calculations and results of the study;

IV.e.ii) limitations of the LCIA results relative to the defined goal and scope of the LCA;

IV.e.iii) the relationship of LCIA results to the defined goal and scope;

IV.e.iv) the relationship of the LCIA results to the LCI results;

IV.e.v) any analysis of the indicator results, for example sensitivity and uncertainty analysis or the use of environmental data, including any implication for the results, and

IV.e.vi) data and indicator results reached prior to any normalization, grouping or weighting shall be made available together with the normalized, grouped or weighted results.

#### IV.f) Life cycle interpretation:

IV.f.i) the results;

IV.f.ii) assumptions and limitations associated with the interpretation of results, both methodology and data related;

IV.f.iii) data quality assessment;

IV.f.iv) full transparency in terms of value-choices, rationales and expert judgements.

#### IV.g) Critical review, where applicable:

### Provisions: 10.3 Three levels of reporting requirements

- IV.g.i) name and affiliation of reviewers;*
- IV.g.ii) critical review reports;*
- IV.g.iii) responses to recommendations.*
- V) **SHALL - Annex:** The annex serves to document elements that would inappropriately interrupt the reading flow of the main part of the report, and are also of a more detailed or tabular technical nature and for reference. It should include: [ISO!]
- V.a) Questionnaire/ data collection template and raw data,
- V.b) list of all assumptions (It should include those assumptions that have been shown to be irrelevant),
- V.c) full LCI results.
- VI) **MAY - Confidential report:** If prepared, the confidential report shall contain all those data and information that is confidential or proprietary and cannot be made externally available. It shall however be made available to the critical reviewers under confidentiality.
- VII) **SHALL - Report for comparative studies:** Reporting on assertive and non-assertive comparative studies intended to be disclosed to the public, the following additional reporting<sup>209</sup> shall be done in addition to the requirements to reports for internal use and third party reports (10.3.3):
- VII.a) analysis of material and energy flows to justify their inclusion or exclusion;*
- VII.b) assessment of the precision, completeness and representativeness of data used;*
- VII.c) description of the equivalence of the systems being compared in accordance with ISO-chapter 4.2.3.7 and related provisions in this document; [ISO!]*
- VII.d) description of the critical review process;*
- VII.e) an evaluation of the completeness of the LCIA;*
- VII.f) a statement as to whether international acceptance exists for the selected category indicators and a justification for their use;*
- VII.g) an explanation for the scientific and technical validity and environmental relevance of the category indicators used in the study;*
- VII.h) the results of the uncertainty and sensitivity analyses;*
- VII.i) evaluation of the significance of the differences found.*
- VIII) **Grouping:** If grouping is included in the LCA, add the following:
- VIII.a) the procedures and results used for grouping;*
- VIII.b) a statement that conclusions and recommendations derived from grouping are*

<sup>209</sup> The parts in italics are directly taken from ISO 14044, chapter 5.3.1, but excluding requirements related to “Grouping”, as grouping of impact indicators is not recommended in the ILCD System. A few aspects have been moved to other places, but all are covered.

**Provisions: 10.3 Three levels of reporting requirements**

*based on value-choices;*

*VIII.c) a justification of the criteria used for normalization and grouping (these can be personal, organizational or national value-choices);*

*VIII.d) the statement that “ISO 14044 does not specify any specific methodology or support the underlying value choices used to group the impact categories”;*

*VIII.e) the statement that “The value-choices and judgements within the grouping procedures are the sole responsibilities of the commissioner of the study (e.g. government, community, organization, etc.)”.*



# 11 Critical review

(Refers to ISO 14044:2006 chapter 6)

The scope and type of critical review desired should have been defined in the scope phase of an LCA, and the decision on the type of critical review should have been recorded (see chapter 6.11).

The critical review is one of key feature in the LCA. Its process shall assure among others whether

- the methods used to carry out the LCA are consistent with this guidance document and thereby also with ISO 14040 and 14044:2006,
- the methods used to carry out the LCA study are scientifically and technically valid,
- the data used are appropriate and reasonable in relation to the goal of the study,
- the interpretations reflect the limitations identified and the goal of the study, and
- the study report is transparent and consistent.

The detailed review requirements regarding what to review and how, and how to report the outcome of the review are given in the separate document "Review scope, methods, and documentation".

More details on the minimum required level/type of review for each specific type of deliverables of the LCI/LCA study can be found in the separate document "Review schemes for Life Cycle Assessment (LCA)".

Eligibility of reviewers is addressed in the separate document "Reviewer qualification".

For LCA studies directed towards public audiences, an interactive review process at various stages of the LCA can improve the study's credibility.

## Provisions: 11 Critical review

Applicable to Situation A, B, and C, implicitly differentiated.

Fully applicable to all types of deliverables, implicitly differentiated.

- I) **SHALL - See chapter 6.11 for key decisions made on the critical review:** The scope and type of critical review desired should have been defined in the scope phase of an LCA (see chapter 6.11). The following provisions repeat these key provisions that otherwise have to be applied at this point: [ISO!]
  - I.a) **Identify minimum critical review type:** Identify along the separate document "Review schemes for Life Cycle Assessment (LCA)" whether a critical review shall be performed and which review type shall be applied as a minimum. This depends on the kind of deliverable of the study, its foreseen decision-context, the kind of intended audience (internal / external / public and technical / non-technical), and whether a comparison is part of the study.
  - I.b) **Select eligible reviewers:** If a critical review is to be done, eligible reviewer(s) shall be selected. Eligibility of reviewers is addressed in the separate document "Reviewer qualification".
- II) **SHALL - Review scope, methods, and documentation:** The selected reviewer(s) shall perform the review and report its outcome along the provisions of the separate

document "Review scope, methods, and documentation"<sup>210</sup>. [ISO!]

---

<sup>210</sup> This document was under preparation when the present document has been finalised. Until it has been published under the ILCD Handbook the relevant ISO 14040 and 14044 requirements shall be met as a minimum.

# 12 Annex A: Data quality concept and approach

(Refers to aspects of ISO 14044:2006 chapter 4.2.3.6)

## 12.1 Introduction and overview

(Refers to aspects of ISO 14044:2006 chapter 4.2.3.6)

The following components and aspects of data quality are used or referenced in various chapters of this document.

ISO 14044:2006 lists under “Data quality” a number of aspects such as representativeness, uncertainty / precision, and other directly data quality related aspects, but also aspects such as methodological consistency, data sources used, and reproducibility.

In the ILCD Handbook, and to better structure quality indicators and assessment as well as the review of LCI/LCA studies, the concept of data quality is addressed by two complementary approaches: Firstly on data quality in the stricter sense, i.e. aspects that determine the quality of the inventory data and the related LCIA results. Secondly to aspects that relate to data quality documentation and review and to efforts of basic consistency such as nomenclature and terminology.

The first approach is named “ILCD data quality indicators” and allows classifying the achieved data quality of LCI data:

- Overall data quality
  - Technological representativeness
  - Geographical representativeness
  - Time-related representativeness
  - Completeness
  - Precision / uncertainty
  - Methodological appropriateness and consistency<sup>211</sup>

In the context of LCA studies, especially including comparisons, this information can then be used to judge in how far the data quality supports conclusions and recommendations from the study. Chapter 12.2 briefly introduces the concepts of these quality aspects as well as of “accuracy” and the difference between “variance” and “variability”.

The second approach covers aspects that do not reflect the actual data quality itself but are complementary:

- Documentation (i.e. providing information of data quality and other aspects as basis for reproducibility)
- Review (i.e. assurance of quality)
- Nomenclature (i.e. to support data consistency in practice by using e.g. the same elementary flows, units of measurement, etc.)

In order to support a quality classification of data sets, the overall data quality (i.e. the integrated “Overall data quality” of the different data quality indicators) and the complementary items are combined to a set of “Overall data set quality”. Given the interest to

---

<sup>211</sup> „Method“ is included as data quality item, as e.g. technological representativeness and the LCI modelling frameworks applied (attributorial and consequential) strongly interrelate.

single out method principles and approaches applied “Method” is additionally used also as criterion for the Overall data set quality. The resulting five criteria can be used to classify data sets<sup>212</sup> as being in line with e.g. the different ILCD Handbook requirements, as follows:

- (Overall) data quality
- Method
- Nomenclature
- Review
- Documentation

This includes the possibility to set fixed requirements for data quality e.g. minimum requirements, or classes of quality such as “high quality”. The latter is used related to completeness or data when quantifying cut-offs etc. Chapter 12.3 provides some more details.

On the level of product comparisons, these data set quality aspects can be used to evaluate and document in how far the achieved data quality supports the conclusions and recommendations from studies and in how far the data basis of the study meets requirements regarding reporting, transparency, review, reproducibility, etc.

While this chapter mainly focuses on LCI data quality, it is to be highlighted, that on the level of LCIA results and LCA studies, of course also the quality of LCIA methods (and if applied: normalisation basis and weighting set) contribute to the overall quality on that level. Of these the uncertainty of LCIA methods can generally be assumed to have the highest uncertainty. Before detailing the two approaches of the Overall data quality indicators and the Overall data set quality indicators, the concepts of the main data quality aspects are described in the next subchapter.

## 12.2 Data quality aspects

(Refers to aspects of ISO 14044:2006 chapter 4.2.3.6)

### **Representativeness and appropriateness**

Representativeness is a key concept in LCA with its three components of technological, geographical and time-related representativeness.

Figure 27 illustrates the concepts of the quality aspects completeness and representativeness. Note that these graphics are not meant to be guidance on how to visualise achieved representativeness but only to illustrate the concept behind this.

---

<sup>212</sup> This is helpful when externally communicating in a harmonised and comparable way the achieved quality of data sets and when searching for data of specific quality characteristics e.g. in the ILCD Data Network.





### Methodological appropriateness and consistency

The choice of the method, especially when modelling whole systems' life cycles, typically strongly influences the results (e.g. attributional vs. consequential modelling, as one example). The choice of the most appropriate modelling principles and method approaches and their consistent use is hence important for the appropriateness and reproducibility of the results. Methods are hence necessarily a data quality aspect. Here it relates to the use of the most appropriate methods as identified for the three archetypal goal Situations A, B, and C plus possible adjustments of the "should" requirements within the permissible deviations, as detailed in chapter 6.5.4.

### Accuracy

The term "accuracy" in general refers to the degree of closeness of a measured or calculated quantity to its actual (true) value. This term includes the influence of methods and method assumptions. Accuracy in LCA hence can be used complementary to precision/uncertainty, capturing the technological, geographical and time-related representativeness as well as appropriateness and consistency of methods and their use.

In a more condensed way, the 6 named data quality aspects can therefore also be shortened to accuracy, precision/uncertainty and completeness.

### Precision / uncertainty

ISO 14044:2006 defines precision as the "measure of the variability of the data values for each data expressed (e.g. variance)". ISO 14044:2006 does not define uncertainty, but uses the term in the sense of expressing the quantitative degree of the lack of precision, i.e. its (negative) measure, i.e. for the error. In science and practice of engineering and statistics, precision is also used synonymous with reproducibility, i.e. the degree to which further measurements or calculations done by different experts show the same results. The ISO definition relates to the statistical meaning of stochastic uncertainty (i.e. variance). The errors can be measurement errors but also choice-errors. Accuracy is here hence used complementary to the ISO usage of precision, i.e. accuracy is the combination of representativeness and methodological consistency.

Note that lack of representativeness of data is a complementary issue, as not a stochastic uncertainty, but a bias.

Figure 28 illustrates the concepts.

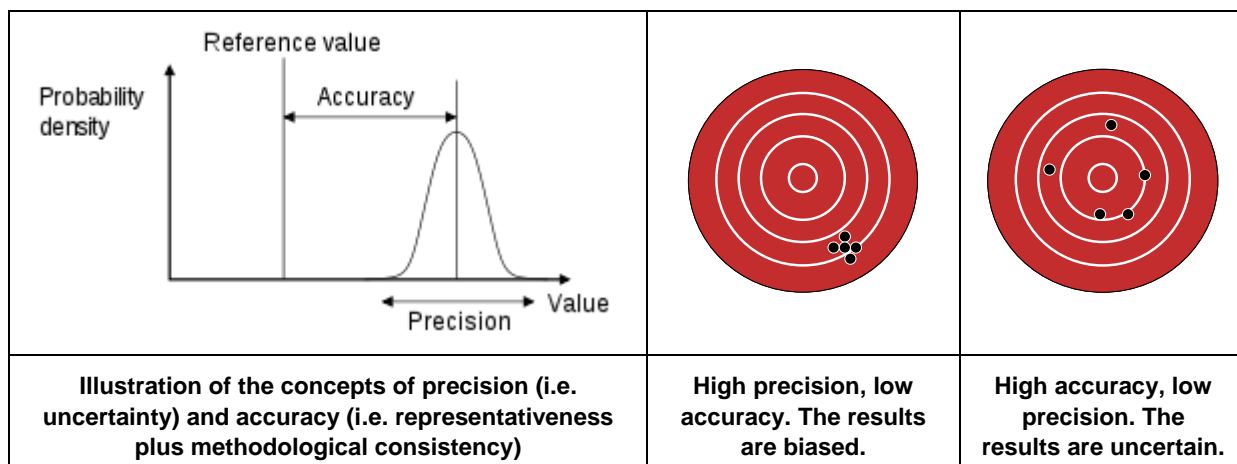

**Figure 28 Illustration of the concepts of precision (i.e. uncertainty) and accuracy (i.e. representativeness and methodological consistency)**

Note that the results of LCA calculations can be accurate but not precise, precise but not accurate, neither of it, or both of it. Note also that very good raw data can lead to inaccurate results if the LCI methods combine these data in an inappropriate way. Both aspects need to be addressed therefore.

### Variance vs. variability

It is suggested to differentiate between "variance" as stochastic measure of uncertainty and "variability" to capture processes and systems that have different LCI data under different e.g. operation conditions: E.g. the LCI data of 100 km average goods transport on a country-wise averaged motorway-overland- inner-city mix with a fleet mix of currently operated EURO 0, 1, 2, 3, 4, 5 motors system of all trucks of equal or more than 7.5 t total weight truck at the average e.g. 80 % load factor may have a certain variance. The single data e.g. load factor, transport distance, specific emission profile of the truck on a motorway etc. has stochastic uncertainties (measurement errors) that aggregated give the data variance. If the data set is based on many measurements it can be very precise, i.e. have a low variance. The variability would refer to the situation where one uses this data set for different, specific kinds of transport situations with different load factors and specific shares of inner-city transport etc. Transport process data sets are hence very variable and the use of an average transport data set - even though it may have a low variance - cannot be used for a specific transport situation, simply as it is not appropriate due to limited technological representativeness - it lacks accuracy. That means that using this average transport data set for specific transport situations, the given variance does not capture the true error, which is due to lack of accuracy.

Note that this differentiation of variance and variability of LCI data sets is not contradicting the ISO 14044:2006 definition of precision (see above), as in ISO variability is explicitly related to the (single) data values that jointly result in the variance.

### Completeness

In addition to accuracy and precision, "completeness" of coverage of all relevant impact categories via the completeness of the inventoried flows can be understood as the third component of data quality<sup>214</sup>.

### Integrated view on data quality

LCA results can be called valid ("of high overall data quality") if they are both accurate, precise, AND complete. The weakest of the criteria generally weakens the overall quality of the specific case. This is reflected by the ILCD data quality indicators (see below in chapter 12.3). In LCA one can hence use the term "validity" to refer to the overall quality of the data (and the results of LCA studies).

Procedurally, one can effectively work towards high quality data, but first precisely identifying the technological, geographical and time-related appropriateness, i.e. what the data set should represent. Next, completeness of the related inventory in coverage all to-be-included and relevant impact categories is aimed at. In quantifying the flows, paying attention to low variance of the values completes the approach.

On a system level, the methodological appropriateness and consistency comes into play.

---

<sup>214</sup> A potential overlap of completeness with precision and accuracy can be argued - data quality aspects could also be differentiated in another way. The given differentiation however relates to widely used terms and concepts (including those of ISO 14044, differentiating precision and completeness) and helps to better understand and address the different kinds of aspects, why they are seen to serve their purpose.

Regarding the final LCA results, this is combined with LCIA characterisation factors (and potentially normalisation and weighting sets) that contribute to the overall quality on system level.

The required overall quality of the results of LCI/LCA study is determined by the intended applications and hence to be derived from the goal definition. The finally achieved quality determines in comparative studies whether differences between systems can be considered significant and robust. For data sets, the overall LCI data quality determines for which cases the data can be used. The overall data quality is hence important information for the evaluation and the interpretation of the results of an LCA: The degree to which the data set's overall representativeness, completeness, precision as well as methodological appropriateness and consistency reflects the reality the data set is representing.

The quantitative precision of the inventory data is an obvious component, but structural and modelling aspects of both the LCI and – if included - the LCIA play an important and often dominating role. Data and structural gaps and modelling assumptions can lead to biases and hence all strongly affect the accuracy of the results, while they cannot be addressed directly or quantitatively in uncertainty calculation. Uncertainty estimates can therefore always only be approximate. They tend to understate not only the true uncertainty but especially do not fully capture the achieved accuracy of the results.

#### **Frequent errors: Overly reliance on stochastic data uncertainty calculations**

It is an increasingly found error to only consider the (known or estimated) quantitative stochastic inventory data uncertainty only and directly use this to demonstrate significance of differences in compared systems.

The overall precision and accuracy however needs to also judge the other, structural components, assumptions, method appropriateness and consistency, limited representativeness of data, and the like. If only a partial analysis is done, it shall be clearly stated that the other part is lacking. In addition, it shall be clearly stated how accuracy and precision have been determined if one or both have been quantified.

It is argued that in practice lack of accuracy is the more relevant problem than stochastic data uncertainty, why especially a lack of addressing the former while reporting the later can be understood as an attempt of misleading the target audience. This is even more so as lack of accuracy typically introduces a bias into the results (see Figure 28).

The judgement of the overall data quality can ultimately only be done by expert judgement. Uncertainty calculations and qualitative or quantified accuracy assessment can substantially help but provide supporting, quantitative information only.

#### **Working with fixed quality requirements**

Sometimes the completeness and precision requirements are stated explicitly for the intended application. For an Environmental Product Declaration (EPD), there may thus be precisely defined quantitative requirements to the completeness and precision given by the applied EPD scheme (e.g. "At least 95 % completeness of overall environmental impact and maximum variance on inventory data lower than 10 % for Climate change and Primary energy, 25 % for Acidification, Eutrophication and Summer Smog impact potentials."). At the same time the qualitative aspects of representativeness are to be addressed. A similar example is the three levels of completeness and precision used for classifying LCI data sets in the ILCD Data Network.

## 12.3 Data quality indicators

(Refers to aspects of ISO 14044:2006 chapters 4.2.3.6 and 4.3.2.1)

The ILCD data quality indicators relate directly to those key characteristics of LCI data sets that describe their quality<sup>215</sup>. These are:

- technological, geographical and time-related representativeness,
- completeness of environmental impacts covered by the inventory,
- achieved precision of the data, and
- appropriate and consistent application of LCI methodologies (the latter especially on the system level)

Table 5 describes the concept of the ILCD data quality indicators / components in more detail.

**Table 5 Overall inventory data quality (validity) and its main 6 aspects**

Indicator component /	Definition / Comment	Chapters
<b>Technological representativeness (TeR)</b>	"Degree to which the data set reflects the true population of interest regarding technology, including for included background data sets, if any."  Comment: i.e. of the technological characteristics including operating conditions.	6.8.2
<b>Geographical representativeness (GR)</b>	"Degree to which the data set reflects the true population of interest regarding geography, including for included background data sets, if any."  Comment: i.e. of the given location / site, region, country, market, continent, etc.	6.8.3
<b>Time-related representativeness (TiR)</b>	"Degree to which the data set reflects the true population of interest regarding time / age of the data, including for included background data sets, if any."  Comment: i.e. of the given year (and - if applicable – of intra-annual or intra-daily differences).	6.8.4
<b>Completeness (C)</b>	"Share of (elementary) flows that are quantitatively included in the inventory. Note that for product and waste flows this needs to be judged on a system's level."  Comment: i.e. degree of coverage of overall environmental impact, i.e. used cut-off criteria.	6.6.3
<b>Precision uncertainty (P)</b> /	"Measure of the variability of the data values for each data expressed (e.g. low variance = high precision). Note that for product and waste flows this needs to be judged on a	6.9.2

<sup>215</sup> This is a different approach compared to generic quality indicators that attempt at capturing data quality by proxy-indicators such as type of used data sources that are used to estimate the quality by overlaying an uncertainty factor to each proxy-indicator (e.g. age of data). The approach chosen here better reflects the case-specific relevance of the aspects: E.g. is four years old data fully representative for technologies that change slowly with time (e.g. basic materials industry), while it would be quite outdated for most IT products.

	system's level." Comment: i.e. variance of single data values and unit process inventories.	
<b>Methodological appropriateness and consistency (M)</b>	"The applied LCI methods and methodological choices (e.g. allocation, substitution, etc.) are in line with the goal and scope of the data set, especially its intended applications and decision support context. The methods also have been consistently applied across all data including for included processes, if any." Comment: i.e. correct and consistent application of the recommended LCI modelling framework and LCI method approaches for the given Situation A, B, or C.	6.5.4

Please note that the components "Completeness" and "Precision" can be quantified (e.g. "90 % completeness/cut-off criterion for overall environmental impact" and "+-10 % LCIA results for Climate change<sup>216</sup>, +-20 % for Acidification, etc.").

The other components are of a qualitative nature and the achieved quality is to be judged semi-quantitatively by experts e.g. during a critical review.

The following quality levels of Table 6 and definitions of Table 7 should be used for documenting what has been achieved for the final data and for each of the data quality indicators:

**Table 6** Quality levels and quality rating for the data quality indicators, and the corresponding definition (for the three representativeness and the methodological appropriateness and consistency criteria) and quantitative completeness and precision / uncertainty ranges in %.

Quality level	Quality rating	Definition	Completeness overall environmental impact	Precision / uncertainty overall env. impact (relative standard deviation in %) <sup>217</sup>
<b>Very good</b>	1	"Meets the criterion to a very high degree, having or no relevant need for improvement. This is to be judged in view of the criterion's contribution to the data set's potential overall environmental impact and in comparison to a hypothetical ideal data quality."	≥ 95 %	≤ 7 %

<sup>216</sup> This percentage refers to the stochastic uncertainty of the inventory values only excluding the uncertainty of the LCIA characterisation factors.

<sup>217</sup> This does exclude the uncertainty of the LCIA method, the normalisation basis, and the weighting set but only of the LCI results, however in view of the overall environmental impact. For log-normally distributed results, the confidence intervals shall be used that are obtained with the percentages given in the table and under normal distribution.

<b>Good</b>	2	"Meets the criterion to a high degree, having little yet significant need for improvement. This is to be judged in view of the criterion's contribution to the data set's potential overall environmental impact and in comparison to a hypothetical ideal data quality."	[85 % to 95 %]	(7 % to 10 %]
<b>Fair</b>	3	"Meets the criterion to a still sufficient degree, while having the need for improvement. This is to be judged in view of the criterion's contribution to the data set's potential overall environmental impact and in comparison to a hypothetical ideal data quality. "	[75 % to 85 %]	(10 % to 15 %]
<b>Poor</b>	4	"Does not meet the criterion to a sufficient degree, having the need for relevant improvement. This is to be judged in view of the criterion's contribution to the data set's potential overall environmental impact and in comparison to a hypothetical ideal data quality."	[50 % to 75 %]	(15 % to 25 %]
<b>Very poor</b>	5	"Does not at all meet the criterion, having the need for very substantial improvement. This is to be judged in view of the criterion's contribution to the data set's potential overall environmental impact and in comparison to a hypothetical ideal data quality."	< 50 %	> 25 %
<b>Additional options, not being quality levels:</b>				
<b>Not evaluated / unknown</b>	5	"This criterion was not judged / reviewed or its quality could not be verified / is unknown."	na	na
<b>Not applicable</b>	0	"This criterion is not applicable to this data set, e.g. its geographical representativeness cannot be evaluated as it is a location-unspecific technology unit process."	na	na

By this way of classifying the achieved overall quality and its components of the developed e.g. unit process or LCI result data set, a structured communication and identification (e.g. sorting/filtering of suitable data e.g. in the ILCD Data Network) is supported.

### Overall data quality and three data quality levels for LCI data sets

In addition to the more differentiated quality levels, for orientation it is useful to label data sets with different levels of overall LCI data quality. The overall quality of the data set can be derived from the quality rating of the various quality indicators / components. As said earlier, the weakest of the quality indicators generally weakens the overall quality of the data set.

The overall data quality shall be calculated by summing up the achieved quality rating for each of the quality components. The rating of the weakest quality level is counted 5-fold. The sum is divided by the number of applicable quality components plus 4. The Data Quality Rating result is used to identify the corresponding quality level in Table 7. Formula 3 provides the calculation provision:

$$\text{Formula 3} \quad DQR = \frac{TeR + GR + TiR + C + P + M + X_w * 4}{i + 4}$$

- *DQR* : Data Quality Rating of the LCI data set; see Table 7
- *TeR, GR, TiR, C, P, M* : see Table 5
- *X<sub>w</sub>* : weakest quality level obtained (i.e. highest numeric value) among the data quality indicators
- *i* : number of applicable (i.e. not equal "0") data quality indicators

**Table 7 Overall quality level of a data set according to the achieved overall data quality rating**

Overall data quality rating (DQR)	Overall data quality level
≤ 1.6 <sup>218</sup>	"High quality"
>1.6 to ≤3	"Basic quality"
>3 to ≤4	"Data estimate"

See Table 8 and the text below for an example.

**Table 8 Illustrative example for determining the data quality rating. Illustrated with a location unspecific technology data set (e.g. a diesel electricity generator for a construction site and of a given emission standard)**

Component	Achieved quality level	Corresponding quality rating
Technological representativeness (TeR)	Very good	1

<sup>218</sup> This means that not all quality indicator need to be "very good", but two can be only "good". If more than two are only good, the data set is downgraded to the next quality class.



<b>Geographical representativeness (GR)</b>	Not applicable <sup>219</sup>	0
<b>Time-related representativeness (TiR)</b>	Fair	3
<b>Completeness (C)</b>	Good	2
<b>Precision / uncertainty (P)</b>	Fair	3
<b>Methodological appropriateness and consistency (M)</b>	Good	2

For the example given in Table 8, the overall data quality rating is calculated as:

$$DQR = (TeR+GR+TiR+C+P^{220}+M+3*4) / (5^{221}+4) = (1+0+3+2+3+2+3*4) / 9 = 2.56.$$

Table 7 helps to identify the corresponding overall data quality level "Basic quality" for the overall data quality rating of that virtual example data set.

### Accuracy, precision and completeness of LCI data, LCIA results and LCA studies including normalisation and weighting

Accuracy, precision and completeness of LCI data should be assessed on the system level. This in addition needs to be done in view of the respective LCIA results, per impact category, but disregarding the (additional) uncertainties and limited accuracy of the characterisation factors (and any eventually applied normalisation and weighting factors) as the focus here is on the requirements to the inventory data.

Accuracy, precision and completeness of LCIA results would than include also the uncertainty and limited accuracy of the LCIA factors.

For LCA studies including normalisation, the respective uncertainty and limited accuracy would be additionally included.

In contrast, for the weighting step (same as for methodological choices and other assumptions), an uncertainty calculation is potentially less suitable. Scenario analysis should better suit to capture the additional lack of robustness any specific weighting method introduces.

## 12.4 ILCD Handbook compliance criteria

(Refers to aspects of ISO 14044:2006 chapters 4.2.3.6 and 4.3.2.1)

### Overview

For structuring the approach of developing ILCD Handbook compliant data and studies as well as product-specific guidance documents or Product Category Rules (PCRs), the ILCD

<sup>219</sup> Not applicable as location unspecific technology data set.

<sup>220</sup> The second occurrence of the lowest level "fair". In the calculation the lowest level rating is multiplied only once with "5", here for TiR.

<sup>221</sup> As "Geographical representativeness" is not applicable here, only five of the otherwise up to six indicators / components are counted.

compliance is composed of five groups of aspects: Data quality, Method, Nomenclature, Review, and Documentation<sup>222</sup>.

These aspects shall also be used when referring only to selected of the ILCD compliance criteria and reporting this partial compliance in a structured way, e.g. when documenting LCI data sets, using the ILCD reference data set format.

The requirements for claiming ILCD compliance for data sets and studies are found in chapter 2.3.

Note that exclusively the "Data quality" compliance is further differentiated by different levels of achieved data quality. The other compliance criteria can only either have been achieved or not; there is not further differentiation.

### Logic of compliance criteria structure

The structure of the ILCD compliance criteria applies the following logic:

- Items that directly relate to the inventory data and impact assessment results data are grouped under "**Data quality**". These were addressed in the preceding chapter 12.3.
- "**Method**" groups all issues around the appropriateness of applied methods and the consistency of their use. This can be assessed without having relevant interrelationships to the underlying data. Note however, that method consistency is necessarily also part of the "Data quality", e.g. technological representativeness means something different under attributional and consequential modelling and consistent use of the methods hence affects the overall achieved representativeness especially of LCI results data.
- "**Nomenclature**" is an issue that predominantly relates to the used naming and structuring of elementary flows and other named elements. This ensure that different practitioners can at all consistently work with the data (e.g. that the elementary flow Carbon dioxide is clearly identified by name, CAS number, measured always in the same unit etc.) and that the LCI data can be correctly linked with the LCIA factors. Correct and consistent use of LCA terminology is a second component under "Nomenclature".
- "**Review**" captures all review aspects.
- "**Documentation**" finally captures several issues: the extent and detail of the documentation as key requirement to support transparency and to ensure that the results can be reproduced. At the same time the documentation is important for the LCA practitioner to know what the data set inventory actually represents and whether it is the appropriate data for his/her systems. The form (report, data set) and format (ILCD reference format, ILCD report template etc) completes the documentation information, making sure that the documented information can be electronically exchanged without loss of information etc.

Note that the exact coverage of items under each aspect and component depends on the type of LCI/LCA study. E.g. will an unit process LCI data set not include certain aspects that relate exclusively to (product) system modelling, etc.

Table 9 gives more details on the compliance criteria.

---

<sup>222</sup> Following the same logic of this set of 5 compliance aspects, also the overall quality of LCIA methods can be described and assessed. More detailed provisions for this are still to be developed.

**Table 9 ILCD compliance of LCI and LCA studies and data sets, direct applications, and derived more specific guidance documents / Product Category Rules (PCR). Compliance aspects, components, brief description and main corresponding chapters (indicative).**

Aspect	Components	Description / Comment	Main chapters
<b>Quality</b>	Completeness	Details see Table 5, Table 6, and Table 7.	Chapter 12.3
	Technological representativeness		
	Geographical representativeness		
	Time-related representativeness		
	Precision / uncertainty		
	Methodological appropriateness <sup>223</sup> and consistency		
<b>Method</b>	Application of LCI modelling and method provisions of this document	Adhering to the provisions for the selection and LCI modelling of the applicable goal situation A, B, or C.	Chapter 6.5.4, and referenced chapters.
	Application of other method provisions of this document	Adhering to the other method provisions of this document.	Other chapters with method provisions.
<b>Nomenclature</b>	Correctness and consistency of applied nomenclature	Appropriate naming of flows and processes, consistent use of ILCD reference elementary flows, appropriate and consistent use of units, etc.	Chapter 7.4.3 and separate document "Nomenclature and other conventions".
	Correctness and consistency of applied terminology	Correct and consistent use of technical terms (LCA and other domains).	Key terms of chapter 3, "terms and concepts" boxes throughout the document, and application of the separate terminology.
<b>Review</b>	Appropriateness of applied review type	Selection of the applicable review type.	Chapter 11 and separate document "Review schemes for Life Cycle Assessment"

<sup>223</sup> See text for reason to include "method..." in both data quality and as separate item "Method"

			(LCA)".
	Correctness of applied scope of review	Correct scope of what is reviewed.	Separate document on "Review scope, methods, and documentation".
	Correctness of applied review methods	Correct methods of how to review each of the items within the review scope.	Separate document on "Review scope, methods, and documentation".
	Correctness of the review documentation <sup>224</sup>	Correct scope, form and extent of what is documented about the final outcome of the review.	Separate document on "Review scope, methods, and documentation".
<b>Documentation</b>	Appropriateness of documentation extent	Appropriate coverage of what is reported / documented.	Chapter 10.
	Appropriateness of form of documentation	Selection of the applicable form(s) of reporting / documentation.	Chapter 10.3.
	Appropriateness of documentation format	Selection and correct use of the data set format or report template, plus review documentation requirements.	See separate ILCD data set format and LCA report template (separately available files).

<sup>224</sup> The documentation of the review findings belongs to the "Review" part, since it does not relate to the documentation of the object of the data set.

## 13 Annex B: Calculation of CO<sub>2</sub> emissions from land transformation

Many aspects influence emissions from land transformations. Their combinations result in the native soil carbon stock, varied by three further influence factors:

- Native soil carbon stock (factors climate region and soil type (Table 10)),
- land use factor (land use type, temperature regime, and moisture regime (Table 11)), and
- management factor (specific land management for cropland and for grassland (Table 12 and Table 13)), and the related
- input level factor (in variation of the above named land management types, in the same tables).

These aspects and resulting factors are derived from the most recent available related IPCC reports and are included in the tables below. CO<sub>2</sub> emissions from any land transformation can be easily calculated by calculating the difference of the steady-state soil carbon content between the land use before and after transformation. This number is then to be multiplied by 44/12 to convert C-losses stoichiometrically to CO<sub>2</sub> emissions. The steady-state carbon stock of each land use is calculated by simple multiplication of its basic soil carbon stock with the loss factors.

Formula 4 and Formula 5 serve to calculate the soil organic carbon stock of the initial and final land use. Formula 6 provides the final prescription.

$$\text{Formula 4} \quad SOC_i = SOC_n * LUF_1 * LMF_1 * IL_1$$

with

- $SOC_i$  = Initial soil organic carbon stock of initial land use "1", given in [t/ha]
- $SOC_n$  = Native soil organic carbon stock (climate region, soil type); Table 10, given in [t/ha]
- $LUF$  = Land use factor; Table 11, dimensionless
- $LMF$  = Land management factor; Table 12 and Table 13, dimensionless
- $IL$  = Input level factor; also Table 12 and Table 13, dimensionless

$$\text{Formula 5} \quad SOC_f = SOC_n * LUF_2 * LMF_2 * IL_2$$

with

- $SOC_f$  = Final soil organic carbon stock of land use "2", i.e. after transformation, given in [t/ha]

$$\text{Formula 6} \quad CO_2 = (SOC_i - SOC_f) * \frac{44}{12}$$

with

- CO<sub>2</sub> = resulting CO<sub>2</sub> emissions from soil (given in [t/ha]) as the difference in soil carbon stocks multiplied by the atomic weight of CO<sub>2</sub> and divided by the atomic weight of C.

Note that this is the total amount of CO<sub>2</sub> that has to be allocated to the individual crops and/or crop years after conversion, as detailed in chapter 7.4.4.1.

At the end of the tables some example calculations are given.

**Table 10 Native soil carbon stocks under native vegetation (tonnes C ha<sup>-1</sup> in upper 30 cm of soil) (IPCC 2006)**

Climate Region	High activity clay soils	Low activity clay soils	Sandy soils	Spodic soils	Volcanic soils	Wetland soils
Boreal	68	NA	10	117	20	146
Cold temperate, dry	50	33	34	NA	20	97
Cold temperate, moist	95	85	71	115	130	
Warm temperate, dry	38	24	19	NA	70	88
Warm temperate, moist	88	63	34	NA	80	
Tropical, dry	38	35	31	NA	50	86
Tropical, moist	65	47	39	NA	70	
Tropical, wet	44	60	66	NA	130	
Tropical montane	88	63	34	NA	80	

**Table 11 Land use factors (IPCC 2006)**

Land-use	Temperature regime	Moisture regime	Land use factors (IPCC default)	Error (±) <sup>225</sup>
Long-term cultivated	Temperate/Boreal	Dry	0.80	9 %
		Moist	0.69	12 %
	Tropical	Dry	0.58	61 %
		Moist/Wet	0.48	46 %
	Tropical montane	n/a	0.64	50 %

<sup>225</sup> Error = two standard deviations, expressed as a percent of the mean; where sufficient studies were not available for a statistical analysis a default, a value based on expert judgement (40 %, 50%, or 90%) is used as a measure of the error. NA denotes 'Not Applicable', for factor values that constitute reference values or nominal practices for the input or management classes. This error range does not include potential systematic error due to small sample sizes that may not be representative of the true impact for all regions of the world.

<b>Permanent grassland</b>	<b>All</b>		1.00	
<b>Paddy rice</b>	<b>All</b>	<b>Dry and</b>	1.10	50 %
<b>Perennial/Tree Crop</b>	<b>All</b>	<b>Moist/Wet</b>	1.00	50 %
<b>Set-aside (&lt; 20 yrs)</b>	<b>Temperate/Boreal and Tropical</b>	<b>Dry</b>	0.93	11 %
		<b>Moist/Wet</b>	0.82	17 %
	<b>Tropical montane</b>	<b>n/a</b>	0.88	90 %

**Table 12 Land management and input level factors for cropland (IPCC 2006)**

<b>Land management (for cultivated land only)</b>				
<b>Land-use management</b>	<b>Temperature regime</b>	<b>Moisture regime</b>	<b>Land management and input level factors (IPCC defaults)</b>	<b>Error (±)<sup>225</sup></b>
<b>Full tillage</b>	<b>All</b>	<b>Dry and Moist/Wet</b>	1.00	NA
<b>Reduced tillage</b>	<b>Temperate/Boreal</b>	<b>Dry</b>	1.02	6 %
		<b>Moist</b>	1.08	5 %
	<b>Tropical</b>	<b>Dry</b>	1.09	9 %
		<b>Moist/Wet</b>	1.15	8 %
	<b>Tropical montane</b>	<b>n/a</b>	1.09	50 %
<b>No tillage</b>	<b>Temperate/Boreal</b>	<b>Dry</b>	1.10	5 %
		<b>Moist</b>	1.15	4 %
	<b>Tropical</b>	<b>Dry</b>	1.17	8 %
		<b>Moist/Wet</b>	1.22	7 %
	<b>Tropical montane</b>	<b>n/a</b>	1.16	50 %
<b>Input level (for cultivated land only)</b>				
<b>Low input</b>	<b>Temperate/Boreal</b>	<b>Dry</b>	0.95	13 %
		<b>Moist</b>	0.92	14 %
	<b>Tropical</b>	<b>Dry</b>	0.95	13 %
		<b>Moist/Wet</b>	0.92	14 %
	<b>Tropical montane</b>	<b>n/a</b>	0.94	50 %
<b>Medium input</b>	<b>All</b>	<b>Dry and</b>	1.00	NA

		Moist/Wet		
High input without manure	Temperate/Boreal and Tropical	Dry	1.04	13 %
		Moist/Wet	1.11	10 %
	Tropical montane	n/a	1.08	50 %
High input with manure	Temperate/Boreal and Tropical	Dry	1.37	12 %
		Moist/Wet	1.44	13 %
	Tropical montane	n/a	1.41	50 %

Table 13 Land management and input level factors for grassland (IPCC 2006)

Land management (for grassland only)			
Land-use management	Temperature regime	Land management and input factors level (IPCC defaults)	Error (±) <sup>225</sup>
Nominally managed (non-degraded)	All	1.00	NA
Moderately degraded	Temperate/Boreal	0.95	13 %
	Tropical	0.97	11 %
	Tropical Montane	0.96	40 %
Severely degraded	All	0.70	40 %
Improved grassland	Temperate/Boreal	1.14	11 %
	Tropical	1.17	9 %
	Tropical Montane	1.16	40 %
Input level (for improved grass land only)			
Medium	All	1.00	NA
High	All	1.11	7 %

In order to calculate the annual changes in carbon stocks due to land-use change, please refer to the following three illustrative examples<sup>226</sup>:

#### Example 1: Transformation of "set-aside land" in the UK for "annual crop production"

##### Aspects:

- Climate Region of UK: Cold temperature

<sup>226</sup> Note: The climate regions, soil types, temperature and moisture regimes, as well and the land use and management adopted in all these examples is for illustrative purposes only.



- Moisture Regime of UK: Moist
- Soil type (typical, average, or specific, e.g. this might be): High activity clay soils  
-->  $SOC_n = 95$  t/ha (Table 10)
- Land use 1 (before transformation): Set-aside land (< 20 yrs)  
-->  $LUF1 = 0.82$  (Table 11)
- Land use 2 (after transformation): Long-term cultivated crop land  
-->  $LUF2 = 0.69$  (Table 11)
- Land management of land use 1: none (as land use is "set-aside land")  
-->  $LMF1 = 1$ <sup>227</sup>
- Input factor land use 1: none (as land use is "set-aside land")  
-->  $IF1 = 1$
- Land management of land use 2: Full tillage  
-->  $LUF2 = 1.00$  (Table 12)
- Input factor land use 2: High input without manure  
-->  $IF2 = 1.11$  (Table 12)

#### Factors from the tables and calculations:

- Original carbon stock of land use 1 =  $95 * 0.82 * 1 * 1 = 77.9$  tonnes of Carbon per ha
- Final carbon stock of land use 2 =  $95 * 0.69 * 1.00 * 1.11 = 72.8$  tonnes of Carbon per ha
- Loss in carbon stock = 5.1 tonnes of Carbon per ha

Resulting annual CO<sub>2</sub> emissions to be attributed to that "annual crop" over the applicable entire time period of use (20 years) =  $5.1 * 44 / 12 = 18.7$  tonnes of CO<sub>2</sub> emissions per ha<sup>228,229</sup>.

#### Example 2: Transformation of forest in Indonesia for annual crop production

- Climate Region of Indonesia: Tropical
- Moisture Regime of Indonesia: wet
- Soil type: Volcanic
- Land use 1: Native
- Land use 2: Long-term cultivated
- Land management and input level of land use 1: none

<sup>227</sup> For no use of the land (i.e. fallow, natural forest, etc.), the land management factor and the input factor are both always = 1; these values are not given in the table that only lists factors for managed land (i.e. cropland and grassland).

<sup>228</sup> The numbers are given per ha (10,000 m<sup>2</sup>) and need to be converted to the e.g. kg of harvested crop.

<sup>229</sup> These numbers are of course to be complemented with other GHG etc. emissions from machine operation, fertiliser production, etc.

- Land management and input level of land use 2: Reduced tillage, low input
- Original carbon stock of land use 1=  $130 * 1.00 * 1 * 1 = 130$  tonnes of Carbon per ha
- Final carbon stock of land use 2 =  $130 * 0.48 * 1.15 * 0.92 = 66.0$  tonnes of Carbon per ha
- Loss in carbon stock =  $64.0$  tonnes of Carbon per ha<sup>230</sup>

Resulting annual CO<sub>2</sub> emissions to be attributed to that "annual crop" over the applicable entire time period of use (20 years) =  $64 * 44 / 12 = 234.67$  tonnes of CO<sub>2</sub> emissions per ha.

### Example 3: Transformation of grassland in Canada for annual crop production

- Climate Region of Canada: Cold temperate
- Moisture Regime of Canada: dry
- Soil type: Sandy soils
- Land use 1: Permanent grassland
- Land use 2: Long-term cultivated
- Land management and input level of land use 1: Nominally managed (non-degraded), medium input
- Land management and input level of land use 2: Full tillage, high input with manure
- Original carbon stock of land use 1 =  $34 * 1.00 * 1.00 * 1.00 = 34$  tonnes of Carbon per ha
- Final carbon stock of land use 2 =  $34 * 0.80 * 1.00 * 1.37 = 37.3$  tonnes of Carbon per ha
- Loss in carbon stock =  $-3.3$ <sup>231</sup> tonnes of Carbon per ha

Resulting annual CO<sub>2</sub> emissions to be attributed to that "annual crop" over the applicable entire time period of use (20 years) =  $-3.3 * 44 / 12 = -12.1$  tonnes of CO<sub>2</sub> emissions per ha, i.e. 12.1 tonnes of CO<sub>2</sub> accumulation / binding as soil organic carbon.

This last example illustrates a land transformation that results in net carbon storage in the soil. Please note that, even though this crop is credited for sequestering Carbon dioxide from the atmosphere to the soil, the temporary nature of this storage may need to be considered in the results interpretation.

<sup>230</sup> Note that the Carbon bound in the biomass (i.e. trees) of the natural tropical forest is several times higher.

<sup>231</sup> Negative loss, i.e. an accumulation

# 14 Annex C: Modelling reuse, recycling, and energy recovery

(Refers to ISO 14044:2006 chapter 4.3.4.3)

## 14.1 Introduction and overview

(Refers to ISO 14044:2006 chapter 4.3.4.3)

Note that this chapter refers to reuse, recycling and recovery from the perspective of the to-be-recycled end-of-life product or waste, i.e. the system that generates it, not from the perspective of a multifunctional recycling or reuse system (e.g. a mixed waste incineration plant). For solving multifunctionality of such multi-waste treatment / recycling processes see chapter 7.2.4.6 for consequential modelling and chapter 7.9 for attributional modelling.

### Terminology “reuse/recycle/recover” and “secondary good” in LCA-context

Through the processing of waste and end-of-life products secondary materials, energy resources, parts and complex goods are regained in a form, which allows to use them in subsequent products. There they can replace primary production of the same or another material, energy form, part, or product. Note also that this always involves some form of processing (and be it only the cleaning of refillable bottles or the in-house storage and transport as in case of internal recycling of e.g. polymer production waste).

#### Terms and concepts: Reuse/recycling/recovery and secondary good

Methodologically, all the different forms of e.g. reuse, recycling, and recovery of energy are equivalent in LCA. This covers e.g. reprocessing of production waste, regeneration of nuclear fuels, restoration of buildings, reclaiming or recovering energy, reusing and further using of parts or goods, refitting of parts for other goods, repair, rehash, etc. To ease reading, all these forms are referred to as “reusing/recycling/recovery” in this document, unless specifically differentiated. A common cover term could not be identified and the most widely understood term “recycling” was found incorrect as being too narrow.

Note that the terms used here do not imply any legal meaning but relate exclusively to the use in LCA methodology.

The product of these processes i.e. the recycled material, recovered energy, or reused or further used part or good etc. is generally referred to as the “secondary good” throughout the text.

The terms closed-loop and open-loop recycling (including two sub-types “open loop – same primary route” and “open loop – different primary route”) are detailed in the subchapters 14.3.2.1 and 14.3.2.2.

### Recycling and multifunctionality

Recycling is methodologically a case of multifunctionality, with the product to be recycled having two functions: firstly the function(s) the product is primarily made for and secondly the function of providing secondary resources for use in subsequent life cycles / systems. This fully applies not only to end-of-life products but to all types of waste, as long as any valuable products are recycled from the waste.

**Frequent errors: Omission or double counting/modelling of recycling**

An error that still in some cases of LCI and LCA studies can be seen is the omission or double counting of recycling. Care must be taken to ensure consistency in modelling and background data, avoiding e.g. that in case background already considers recycling, the recycling is modelling twice, respectively in case it is not included in the data that it is correctly modelled once.

**Dispute over the correct way how to model recycling**

The correct way how to model recycling has been extensively discussed over the past two decades. Many approaches have been suggested. These range from simple cut-offs, i.e. assigning all waste management burdens and benefits of having a valuable secondary good to the second system, to a wide range of combinations of how the primary production, the waste pre-treatment, recycling steps and waste land-filling are to be shared between the first and second life cycle (and directly or indirectly the subsequent life cycles). Some of these approaches are more closely derived along the ISO hierarchy. Some (including some that have been developed in pre-ISO times) look at the justice of allocation, trying to provide incentives for an increased use of secondary goods and increased recyclability via the allocation / substitution procedures. It can also be observed that most of the discussions on how to model recycling are in fact discussions on whether to use attributional or consequential modelling in the first place. Others relate to the question whether the ISO hierarchy should be generally followed or whether the way how recycling is modelled should be derived from the goal of improving the situation (i.e. to implement incentives that award the use of secondary goods respectively improved recyclability of products).

**ILCD guidance: Goal-oriented application of the ISO hierarchy**

It is argued here that the appropriate LCI modelling provisions are to be derived by applying the ISO hierarchy based on the decision-context of the goal of the LCI/LCA study. There is no free choice but the goal limits the options. However, it will also be discussed whether the ILCD approach to recycling provides the appropriate incentives to improve the situation regarding increased use of secondary goods and improved recyclability of products, as for the given case indicated.

**Terms and concepts: Recycling in ISO 14044:2006**

ISO 14044:2006 states that the allocation hierarchy applies also to recycling situations. It is clarified that in cases of recycling the drawing of the system boundary (between the first and subsequent life cycles) needs special attention and justification. In addition (and implicitly referring to those cases where substitution is to be applied) any change in the inherent properties of the secondary good must be taken into account.

As allocation criteria (implicitly referring to cases of attributional modelling and where allocation is to be applied) the following ones should be used: Physical properties (e.g. mass), economic value (price ratio secondary good to primary production), the number of subsequent uses of the secondary good.

**Attributional modelling of recycling**

From the perspective of attributional LCI modelling it is appropriate to assign to both the system that generates the waste or end-of-life product and to the one that uses the secondary good the corresponding share of the inventory (e.g. emissions, consumables etc.).

Important is that the allocation is done - strictly spoken - not between the first and second life cycle, but between the two co-functions that the reused, recycled or recovered good performs once for the primary product and ones for further products as the secondary good.

Note that as a preceding step the true joint process (see Figure 29) needs to be identified for all cases.

### Consequential modelling of recycling

From the perspective of consequential modelling, the modelling is to reflect the consequences of the recycling. This implies that it has to motivate – to the most appropriate degree – both recycling (both quantitatively and qualitatively) and the use of the secondary good (again both quantitatively and qualitatively, e.g. in high value applications, substituting high value primary production). In the case of consequential modelling, the superseded mix of processes is to be determined and their avoided production is credited. This is detailed in chapter 14.5.

Note that also for consequential modelling of reuse/recycling/recovery the true joint process (see Figure 29) needs to be identified.

Before developing the guidance for how to model recycling in line with the goal and scope of the LCI/LCA study, the two main different recycling situations (“closed loop” and “open loop”) will be explained. A sub-case of open loop recycling (“same primary route”) is introduced.

## 14.2 True joint process and true co-product

### True joint process and co-product - consequential modelling

The true joint process of the generated waste or end-of-life product is that process earlier in the life cycle of the analysed system, where the function (e.g. a primary aluminium bar) is technically approximately equivalent to the secondary good produced from the waste or end-of-life product (e.g. an aluminium bar produced from aluminium scrap). I.e. in this example, the primary aluminium bar would be the true joint product of the secondary aluminium bar.

That means that first the true joint process has to be identified that is understood to produce both the primary and secondary good. Figure 29 illustrates the principle: the true joint process is the process step "M1" that produces a technically about equivalent good "Xj" to the secondary good "Xc" that has been obtained via recycling. The same principle applied for production waste that is recycled.

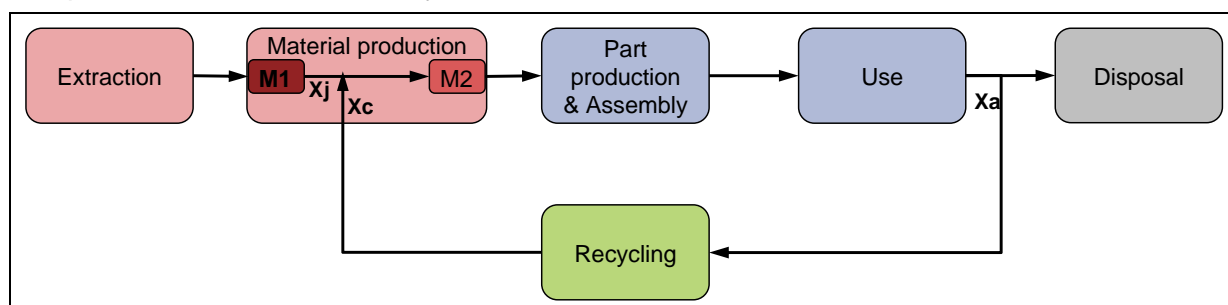

**Figure 29** True joint process (M1) and true co-product (Xj) for the secondary good (Xc) obtained from recycling of an end-of-life product, under consequential modelling; schematic. Under attributional modelling, Xj is the co-product of Xa, if the latter has a positive market value, i.e. is a valuable product.

For cases of "open loop - different primary route" recycling (for the concept see chapter 14.3.2.2) the true joint process and co-product is slightly more difficult to be identified: this is,

since the secondary is not of the same type of good as the primary good from which is derived. An example: Heavily soiled postconsumer paper packaging waste is incinerated and electricity produced. Which is the true joint process, as electricity has not been an interim production step from wood to the paper? In such cases, the process that produces a product with the minimum required functional characteristics that would be equivalent to the secondary good (e.g. electricity, as in the above example) should be considered the true joint process. This can mean to go back to the initial resource extraction, i.e. ignoring all further processing steps (except for the transport to the location where the waste is e.g. incinerated, as in this example). Here this could be e.g. the round-wood logs delivered to the paper mill, which could be found to be the true joint product and process for the electricity. The logic is the same as before, i.e. to exclude all earlier processing steps that are not required towards obtaining a technical equivalent to the secondary good (here: electricity). In this example these would be all preceding manufacturing steps of the wood including fibre production, papermaking, paper use etc. These are exclusively required for the product of the first life cycle and hence entirely attributed to it; same as all the initial waste treatment steps of the negatively valued waste that are attributed to the first life cycle. However, the production of the e.g. round wood is the basis for both the first life cycle and for the second and further life cycles.

### **True joint process and co-product - attributional modelling**

The principle for this step is the same as under consequential modelling, with the difference that the final secondary good after recycling is not the co-product for which the true joint process and true co-product are identified: Under attributional modelling, this co-product is the waste or end-of-life product as it is generated, if its market price is positive ("Xa" in Figure 29). Otherwise, if this market price is negative, the co-product is that valuable good that is directly produced by the process step that is located at the boundary between the first and second life cycle (see Figure 33). I.e. in contrast to consequential modelling, the further steps of recycling etc. are not modelled, but at a maximum the initial treatment steps towards the first valuable product with at least minimum positive market value.

Once the true joint process has been identified, the attributional and consequential modelling provisions are applied, as required. For attributional modelling that means that the two-step allocation guidance is applied as for all multifunctional processes. This is detailed in chapter 14.4.1, applying this general approach to waste and end-of-life product reuse, recycling, and recovery.

## **14.3 Concepts: Closed-loop and open-loop recycling**

(Refers to aspect of ISO 14044:2006 chapter 4.3.4.3)

### **14.3.1 Closed-loop recycling**

(Refers to aspect of ISO 14044:2006 chapter 4.3.4.3)

The simplest form of recycling is closed-loop recycling: the secondary good is shunted back to an earlier process in the same system where it directly replaces ("supersedes") input from primary production of the same e.g. material.

An example is the recycling and re-melting of runners from a flow injection moulding process, where the recycled high-density polyethylene directly replaces virgin high-density polyethylene in the inlet to the process ("internal production waste recycling"). Another example is the use of refillable 5 l aluminium kegs for packaging of beer. The consumer pays a deposit, which ensures that a high percentage of the kegs are returned for refill where they supersede an input of newly produced kegs ("reuse").

Schematically closed-loop recycling is shown in Figure 30.

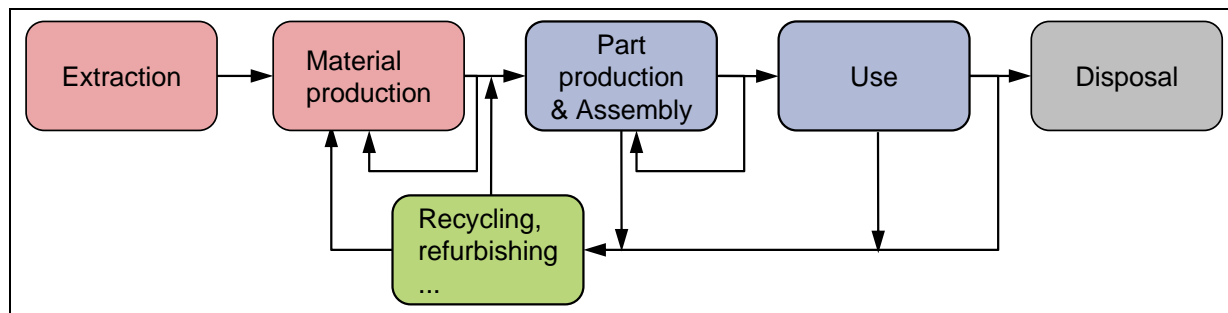

**Figure 30** "Closed loop" recycling (schematic): The recycled material, recovered energy, or reused part/product is entering again the supply-chain replacing the input of newly produced materials, energy or parts. In the cases of process-internal recycling this can even happen without any environmentally relevant recycling process (see internal loop leaving and re-entering the "Material production" process).

There is one variant of recycling that is sometimes interpreted as closed-loop recycling, while it is in fact a form of open-loop recycling: the secondary good is used within the same system, but it is substantially changed during recycling. A prominent example is the incineration of e.g. post-consumer plastic waste with energy recovery in form of e.g. electricity. Even though the analysed system may also use electricity and the recovered energy in form of electricity may be modelled to replace this electricity, the secondary good (i.e. electricity) is a very different product than the original material (i.e. polymer), why such cases belong to "open-loop recycling".

It is to be noted that sometimes it is difficult to differentiate between closed-loop recycling and open-loop recycling: e.g. in the 5 l aluminium keg example the keg-refilling plant will have seen some minor modifications at the time when the used kegs are returned for another refill. Or beer of another producer is filled into the keg, hence it is not resulting in the same product. It is however providing again the same functional unit, why this is easier to be understood as closed-loop recycling from the perspective of the keg. In the injection moulding example, the machine may produce some other kind of polyethylene parts, i.e. formally another system. From LCA perspective it can be argued that what matters most, is that the secondary good is providing again the same functional unit, independently whether it is used in the same or another product. I.e. as long as the secondary good is not changing its inherent technical properties and provides the same functional unit, closed-loop recycling best captures the situation. However, to ensure robustness and plausibility of results, as well as applicability in daily practice, there is hence a need for a coherent treatment of closed-loop and open-loop cases in any case.

### 14.3.2 Open-loop recycling

(Refers to aspect of ISO 14044:2006 chapter 4.3.4.3)

A more complex and more common form of recycling is the open-loop recycling, where at least a share of the secondary good is used in different systems. Open-loop recycling is frequent for recyclable materials that often are recycled to the same type of material, but are used for at least somewhat different products (e.g. recycled steel from a soft drink can is used to produce a beer can). Two variants should be differentiated: "Open loop - same primary route" (in ISO 14044:2006 described as "*open-loop product system where no changes occur in the inherent properties of the recycled material*") and "Open loop – different primary route" (in ISO 14044:2006 "*open-loop product systems where the material ...*").

undergoes a change to its inherent properties"). These imply a somewhat different modelling of the recycling inventory:

### 14.3.2.1 Open loop - same primary route

(Refers to aspect of ISO 14044:2006 chapter 4.3.4.3)

The case of closed-loop recycling, in the stricter sense, is not very common as discussed above. From the perspective of the materiality and the potential replacement of primary production, as modelled in consequential modelling, there is however no strict necessity that the secondary good is used for the same product. Important is, that it is replacing the same primary production route. To support this differentiation, a respective sub-type of open-loop recycling is used here that stands between closed-loop and open-loop recycling: “closed loop - same primary route” recycling.

An example: if steel cans are recycled to steel cans, this would be closed-loop recycling. If steel cans are recycled to tailored blanks for cars, this would be open-loop recycling. But if both the steel cans and the tailored blanks need the same steel basis they are identical regarding their primary route. This would also be applicable if the secondary good would be degraded during the recycling process, as often for e.g. for recycled polymers. Important is hence only that the secondary good effectively substitutes the same primary route, also if it does not replace the same but a lower amount. This situation is therefore called “open loop - same primary route”. Figure 31 illustrates this schematically.

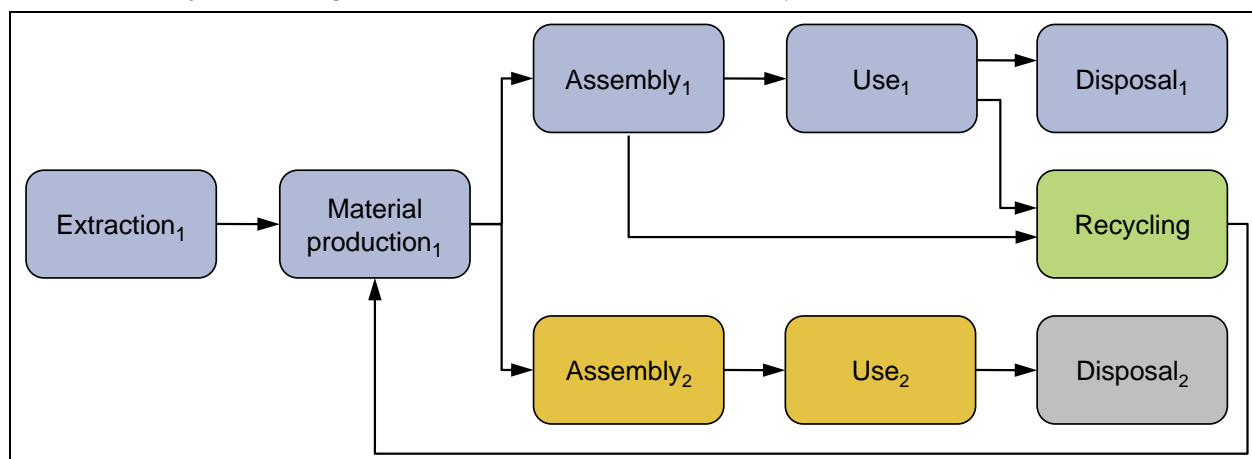

**Figure 31** “Open loop - same primary route” recycling: Waste or the end-of-life product from the first system (light blue) is collected and recycled/pre-treated (green) and brought to use in OTHER systems (dark blue), but is replacing the SAME primary route of its first life cycle.

### 14.3.2.2 Open loop - different primary route

(Refers to aspect of ISO 14044:2006 chapter 4.3.4.3)

The other sub-type of open-loop recycling, here referred to as “open loop - different primary route”, is where the secondary good replaces a different kind of material, energy or part while with the same or very similar function. An example is the incineration of post-consumer plastics with energy-recovery as electricity and use of the electricity in other applications.

The criteria for identifying whether a secondary good is replacing the same or a different primary route and material, energy or part is not always straightforward and gradually different interim cases exist.

Schematically the “open loop – different primary route” recycling is shown in Figure 32.



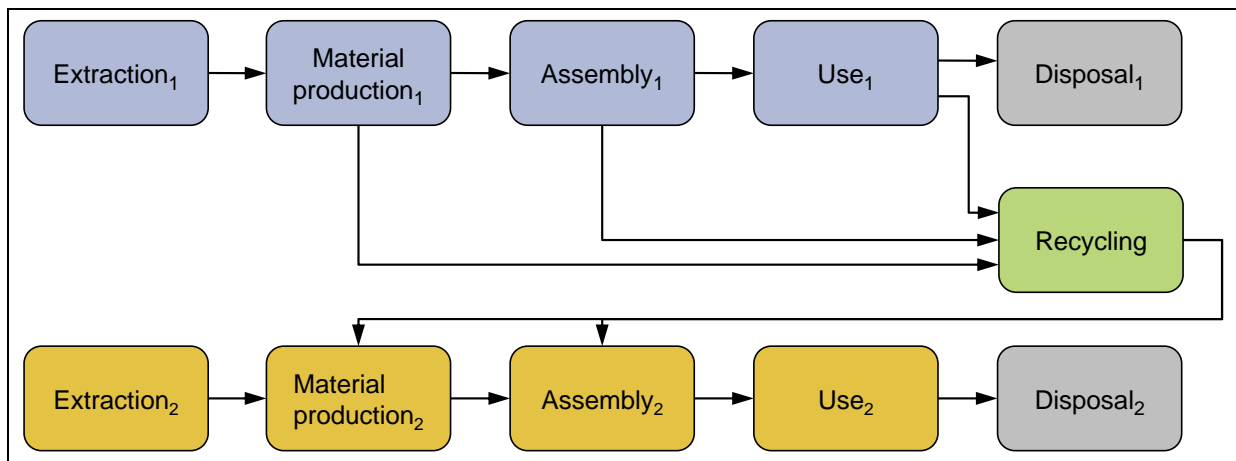

**Figure 32** “Open loop - different primary route” recycling: Waste or the end-of-life product from the first system (light blue) is collected and recycled/pre-treated (green) and brought to use in another system (dark blue), replacing a different primary production route.

The open-loop recycling can in addition be anonymous in the sense that it is unknown (or exceedingly laborious to find out in practice) in which one or many system(s) the secondary good will be used (e.g. in case of electronic end-of-life product recycling in third countries). This causes additional difficulties in pinpointing the superseded processes in substitution.

Often however, the one or many uses of the secondary good are known or can be sufficiently identified and quantified.

## 14.4 Recycling in attributional modelling

(Refers to aspect of ISO 14044:2006 chapter 4.3.4.3)

### 14.4.1 Detailed aspects of attributional modelling of recycling

(Refers to aspect of ISO 14044:2006 chapter 4.3.4.3)

#### 14.4.1.1 Introduction

(Refers to aspect of ISO 14044:2006 chapter 4.3.4.3)

The following main questions come up when modelling recycling in attributional modelling:

- Where to draw the system boundary between the first and subsequent life cycles?, and
- How to apply the ILCD two-step allocation procedure to these cases?

The following information is required for answering these questions:

- The market value of the waste or end-of-life product,
- If the market value is below zero: Is there any valuable secondary good generated during treatment and if so in which processing step?, and
- In any case: What are its physical characteristics and market value?

The two cases of market value above and below zero need to be differentiated, as explained below:

## 14.4.1.2 Market value of waste / end-of-life product is above zero, i.e. it is a co-product

(Refers to aspect of ISO 14044:2006 chapter 4.3.4.3)

### Introduction

If the market value of the waste / end-of-life product at its point of origin is above zero, in LCA perspective it is a co-product and the multifunctionality is to be solved by allocation. This is done applying the two-step procedure as detailed in chapter 7.9.3. As a special step, the true co-producing process is to be identified: this is that process step that has produced a product that is technically most similar to the waste / end-of-life product.

The case of recycling is insofar different from the general case of multifunctionality, as the secondary good is not only a co-function of the system but itself is again and again recycled (while each time at lower amounts and/or quality, considering losses of each loop). We have hence many co-products, respectively a higher amount of secondary good uses than the amount available after the first recycling round. When aiming at identifying an inventory for the secondary good this is to be considered.

Applying strictly attributional modelling, allocating by physical causality, these differently often recycled secondary goods have different inventories: some have only had e.g. one preceding recycling round, others e.g. 10. To come to an average inventory, the inventories of the different amounts of differently often recycled secondary good are to be integrated and averaged". This is required in practice, as the number of cycles a secondary good already has made typically cannot be measured and also as typical questions relate to the average product, not the specific cycle.

### First step: Total amount of uses

When an end-of-life product is recycled, some fraction of the original material, parts or energy is obtained as secondary good and incorporated into a new product. If the product made from this secondary good is itself recycled, a smaller fraction of the original material, part, or energy is again obtained and incorporated into a third product. Given the recyclability and losses during recycling, the shares of the differently often recycled secondary goods in the market can be calculated. This can be summed up to represent the total amount of one unit of material that effectively has been used, once all material is lost after in theory indefinite loops of recycling: This total amount of use " $U$ " is the sum of the amount of primary use " $p$ " plus amount obtained after first recycling round, plus amount obtained after second recycling round, etc. An example: If one has 1 kg of a packaging made from primary route material X and can recycle the packaging - with 90 % recycling rate, the total amount of uses from the primary materials is 1 kg + 0.9 kg, + 0.81 kg + 0.729 kg etc. It can hence be calculated from the total number of times " $n$ " that the original material, part or energy content is recycled and by the recycling rate " $r$ " of each step.

For the first two recycling loops one obtains " $u$ " accordingly as:

$$\text{Formula 7} \quad u' = p + p * r + p * r^2$$

$u'$  total amount of uses after first and second recycling loop

$p$  primary amount

$r$  average recycling rate [0...1), incorporating both collection efficiencies and processing efficiencies

With " $n$ " as total number of loops, and simplifying the resulting mathematical series, the total amount of uses after  $n$  loops is:

$$\text{Formula 8} \quad U = \sum_{i=0}^n p * r^i = p * \left( \frac{1 - r^{n+1}}{1 - r} \right)$$

- $U$  total amount of use  
 $i$  recycling loop number  
 $n$  total number of recycling loops

In the above example of starting with  $p = 1$  kg and a recycling rate of 95 % ( $r = 0.95$ ) after indefinite number  $n$  of loops one obtains a total amount of use of 20 kg (as in that case  $U = p/(1-r)$ ).

### Second step: Total life cycle inventory of total amount of use

The total life cycle inventory of the total amount of use is the sum of the inventories of primary production " $P$ " (up to the level of quality of the waste / end-of-life product), all recycling loops " $R$ ", and all final waste management of not recycled fractions and other losses " $W$ ". The repeated recycling processes and the disposal contribute to the total inventory. This total inventory hence includes all processes up to the level of the quality of the primary material, energy carrier or part as obtained also later via recycling, plus all recycling and waste treatment steps. It does not include however any of the processes from the manufacture and use of the products made from the material, energy carrier or part because those processes are not physically related to the production of the later reused/recycled/recovered material, energy carrier, or part<sup>232</sup>.

As prescription one obtains:

$$\text{Formula 9} \quad I = p * (P + W + R * (r - r^{n+1}) / (1 - r))$$

- $I$  total LCI of total amount of use of one initial unit of primary material, part or energy carrier  
 $P$  LCI of primary production per unit of material, part, or energy carrier  
 $R$  LCI of effort for reuse/recycling/recovery per unit of material, part, or energy carrier

<sup>232</sup> This can best be explained along an example: an aluminium beverage can, as an illustrative example, has as first co-function the function to carry and protect the beverage it contains, its second co-function is the aluminium scrap (i.e. the end-of-life can) it provides as secondary resource for subsequent product systems. To provide the first co-function of delivering the beverage, the can has to be produced, of course. To provide the second co-function of being a secondary resource in form of scrap it is however sufficient if the aluminium grade the can is made of is produced, while all other steps of transporting the aluminium to the can plant, making the can, etc. are not related / attributable to the provision of the scrap. Hence both co-functions share the production steps until the aluminium grade that is equivalent to that of the scrap is produced. The true co-producing process is hence the one that produces the e.g. metal bar in the quality as it is also available in the e.g. scrap.

$W$  LCI of final waste management per unit of discarded material, part, or energy carrier

### Final step: Average inventory per unit and value correction

Now the determining physical allocation criterion is to be determined to allocate these cradle-to-gate inventories of the material, energy, or part between the two co-functions. In this case, the criterion is simply mass, as the amount of material, part or energy carrier that is physically required for both co-functions is obviously the same. From this one can obtain the average inventory "e" per unit of material, part, or energy carrier, dividing the total life cycle inventory of the total amount of use "I" by the total amount of use "U":

$$\text{Formula 10} \quad e = \frac{I}{U} = \frac{p * (P + W + R * (r - r^{n+1}) / (1 - r))}{p * (1 - r^{n+1}) / (1 - r)}$$

e average LCI per unit of material, part, or energy carrier

The above expression for "e" can be further simplified as follows:

$$\text{Formula 11} \quad e = \frac{(P + W) * (1 - r) + R * (r - r^{n+1})}{(1 - r^{n+1})}$$

With an indefinite number of loops the expression  $r^{n+1}$  approximates 0 (as  $r \in [0...1)$ ) and the formula is simplified to yield the final version:

$$\text{Formula 12} \quad e = (P + W) * (1 - r) + R * r$$

Note that this assumes technical equality between primary produced and reused/recycled/recovered material, part, or energy carrier. If these differ (e.g. as for many recycled polymers), a correction factor is to be introduced. This factor can be understood to correct for not full equivalence of the technical quality of the primary produced material/energy or part from the true co-producing process and the end-of-life product. Especially for complex end-of-life products, this also captures the additional effort for e.g. dismantling towards isolating the different materials or parts. This correction factor should be the market price ratio of secondary/primary material, part, or energy carrier.

#### 14.4.1.3 Market value of waste / end-of-life product is negative (i.e. a waste treatment fee is to be paid)

(Refers to aspect of ISO 14044:2006 chapter 4.3.4.3)

In those cases where the waste / end-of-life product cannot directly be sold, it is not a co-product but waste. However, there are two types of cases to be differentiated:

- In those cases where during the waste treatment no valuable product is produced at all (e.g. the waste is directly land-filled, incinerated without energy-recovery, etc.), all waste treatment steps are to be modelled and the inventory is fully to be assigned to the first system that has generated the waste / end-of-life product.

- In those cases, where during the waste treatment processes a valuable product is produced (e.g. electricity from waste incineration or a secondary good after some additional cleaning and treatment steps, etc.), this secondary good is a co-product of the first system and an allocation is to be applied. This leads to the question, which burden this secondary good is to carry.

It is argued that all treatment processes that are necessary until the treated waste / end-of-life product is achieving a market value of zero are within the responsibility of the first system (i.e. process steps P1 to including Pn-1 in Figure 33). This is because the waste or end-of-life product is generated by the first system, while a waste can per se not carry any burden of treatment. Furthermore is it considered inappropriate to attribute all preceding waste treatment processes to the eventually produced secondary good<sup>233</sup>.

An allocation of burdens to the secondary goods can plausibly therefore only be done at that process step where a valuable secondary good is produced (Pn).

The following procedure shall be applied:

Modelling firstly the waste / end-of-life management/treatment processes until the treated waste crosses the "zero market value" border (see Figure 33). Subsequently the two-step allocation procedure is to be applied on this process step.

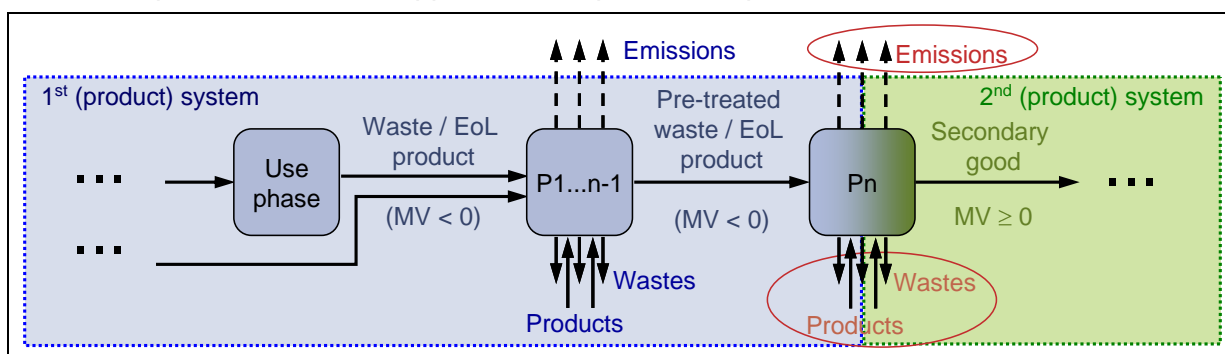

**Figure 33 Allocation of waste / end-of-life products if the management / treatment processes result in any valuable product (secondary good):** In addition to the allocation of the good of the true joint process and the secondary good, the inventory of the treatment process step P<sub>n</sub> where the waste crosses the zero market value border ( $MV < 0$  to  $MV \geq 0$ ) is to be allocated between the two life cycles: The encircled emissions, wastes and products / consumables are to be shared between the pre-treated waste / EoL product (i.e. the first system) and the secondary good (i.e. the second system). See text for details.

Note that for the "market price is below zero" case, a double allocation is to be done: Firstly between the co-products of the true joint process (i.e. the primary good that is about equivalent to the secondary good), as always. Secondly, and in addition, between the pre-treated waste / end-of-life product that enters the process P<sub>n</sub> that stands at the border between the first and second life cycle and the secondary good that leaves it (see Figure 33).

For both these two allocations, the same two-step procedure of chapter 7.9.3 is applied:

1<sup>st</sup> criterion of determining physical causality: if such exists during the process step when a valuable product (secondary good) is obtained, the corresponding inventory values are allocated between the first life cycle and the secondary good.

<sup>233</sup> An example: if the waste is a highly toxic waste that needs special transport, storage and treatment in a waste incineration facility and finally a little amount of electricity is produced, this cannot justify assigning the high environmental impact of the waste treatment incl. depositing of remaining waste and ashes to the electricity. For accounting different versions of products over time, this approach would e.g. not capture improvements in the quantity or quality of wastes and end-of-life products.

2<sup>nd</sup> criterion of market value: the remaining inventory exclusively of the process step that produces a valuable product (secondary good) is allocated with the market value criterion between the secondary good(s), i.e. the second life cycle, and the (potentially pre-treated) waste / end-of-life product that enters this process step, i.e. the first life cycle.

Note finally that the market value of the pre-treated waste / end-of-life product before it enters the process step that finally produces a valuable secondary good, is below zero and that hence the absolute value of its (negative) market price<sup>234</sup> shall be used when allocating between the first and second life cycle. The rest of the allocation calculation is the same.

**Note: the Provisions of this annex are found in the main text, in chapter 7.9.3.**

## 14.5 Recycling in consequential modelling

(Refers to aspect of ISO 14044:2006 chapter 4.3.4.3)

### 14.5.1 Introduction and overview

As explained earlier, reuse/recycling/recovery in consequential modelling is methodologically equivalent to other situations of multifunctionality. It has some special aspects that are logically derived from the same modelling approach while they lead not always to immediately intuitive solutions. They are explained in this chapter.

### 14.5.2 Recyclability substitution approach

(Refers to aspect of ISO 14044:2006 chapter 4.3.4.3)

The recyclability substitution approach (also called "end-of-life recycling" or "recycling potential" approach<sup>235</sup>) follows the logic of consequential modelling<sup>236</sup> and is its archetypal approach for solving multifunctionality. This mechanism stimulates high recyclability in both quantity and quality. Note that the content of recycled material in the product itself is not directly considered in the final inventory, as that amount is corrected by the product's recyclability. In the further text, details are provided how and why this approach (combined with a correction for reduced technical properties/functionality) is also appropriate in case the recycled content needs to be stimulated for the material that is analysed.

The recyclability substitution approach is described in the following Box and illustrated in Figure 34.

---

<sup>234</sup> If the market value / gate fee of the pre-treated waste is e.g. „-1 US\$“, the market value used for allocation would be „1 US\$“. (One can interpret this also as an allocation between the secondary good and the waste treatment service that is here priced at "1US\$").

<sup>235</sup> The term "recycling potential" is not well capturing - at least for short-lived products - that the actually achieved recycling rate is used. The term "end-of-life recycling" is only covering end-of-life products, but no production waste and has no methodological reference in its name. Hence, a different term is used here, combining the used criteria "recyclability" with the applied method "substitution".

<sup>236</sup> See the footnote 24 on the question whether this approach and substitution in general are an attributional or a consequential approach. In fact, it is argued to be an approach both to model "additional consequences" (as done in Situation A and B) and "existing consequences" (as done in Situation C1); the latter could also be termed "interactional".

### Terms and concepts: Recyclability substitution approach

In the recyclability substitution approach, the avoided inventory of primary production of a good is credited to the end-of-life product or waste according to the degree that it is recyclable. Only the amount of good that cannot be quantitatively obtained back from the secondary good (i.e. losses due to incomplete collection, losses during recycling, etc.) is modelled as primary production. The recycling efforts, deposition of any finally remaining waste etc. and the related impacts are part of the first life cycle. Note that this is analogous to substitute the mix of the most cost-competitive or least cost-competitive processes/systems.

An example for "closed loop" and "open loop - same primary route" recycling (see Figure 30 and Figure 31, respectively): A product Y, made from only one material X (to make the example clearer) is produced from 2 kg primary material and 2 kg secondary material (i.e. recycled content = 50 %); see top graphic in Figure 34. The 3.5 kg that are recycled result in 3 kg secondary good of the same quality as the one produced via the primary route (recyclability by mass = 75 %). The surplus of 1 kg secondary good, that is not required for the product's production, is substituted (see the curved arrow and the "S" in the graphics) by 1 kg primary production of material X ("-1 kg"). This results in an effective inventory for the analysed system of 2 kg - 1 kg = 1 kg of the primary-produced material X, plus its assembly and use stage, plus the "recycling-processes-only" inventory of 3.5 kg of the recycled end-of-life product, plus waste disposal processes for each 0.5 kg of the directly deposited end-of-life product and 0.5 kg of waste generated during recycling. Note that it does not matter whether the 2 kg used secondary material stem from the recycling of this product or any other product made of that material. (In case the quality of the secondary material would be lower than the quality of the primary material, this would be considered by crediting a lower amount or by market-value correction).

If in the above example, the recyclability would be lower than the recycled content, e.g. resulting in only 1 kg secondary material (second graphic in Figure 34), the lacking 1 kg of material would be added by primary produced material X ("1 kg"), to complete the required 4 kg.

Applying the same approach, but this time for another product, assuming that the secondary material X would normally not be used but disposed off (see third graphic in Figure 34): if 3 kg of the secondary material X are produced but only 2 kg are used in the production of the product, 1 kg needs to be disposed off; this is to be modelled instead of crediting avoided primary production ("1 kg" to disposal; see lower left process box). If however the analysed product would use more secondary material X than it produces (bottom graphic in Figure 34), this means that the here additionally required 1 kg of secondary X has to come from somewhere else. As any additionally produced amount secondary X is disposed off, this additional demand diverts 1 kg of secondary material X from landfill, i.e. the product gets a credit of 1 kg avoided disposal ("-1 kg" avoided disposal; see lower left process box).

In summary, this approach is rewarding a high recyclability, especially of valuable resources/goods and/or recycling to higher value secondary goods. Recycled content is rewarded when otherwise unused/landfilled secondary resources are used.

Note that the routes of primary production and of the substituted primary production do not need to be identical, as e.g. a specific route may be used for the purchased material, while the credit would be given for the mix of the most cost-competitive routes (under full consequential modelling; but see simplifications for Situation A, B, and C1).

Lower quality of the secondary good is considered by substituting accordingly less primary production or applying value correction (details see chapter 14.5.3.3).

Note that the recyclability substitution approach applies fully analogously to production waste and to other forms than recycling such as energy recovery, parts reuse, etc.

An example for open-loop recycling, with the example of "further use" of a product: If I produce a metal-table of 4 kg metal X and after some years, I foresee a further use of the table (e.g. high class restaurant that is selling their tables after 5 years for further use elsewhere). The alternative route for the buyer of these tables is the primary production of such a table. Given the 5 years reduced average lifetime (at a total technical lifetime of e.g. 20 years), we would give a credit<sup>237</sup> of  $15/20 = 75\%$  of the inventory of the newly produced table. These 75 % of the remaining lifetime is the functional equivalent the product has. In addition, after its useful life the table can still be recycled, achieving an e.g. 87.5 % recyclability rate, i.e. 87.5 % (i.e. 3.5 kg) primary metal production would be credited to the combined life cycles of the first and second use of the table. If the original table was produced with 2 kg primary metal X and 2 kg secondary metal X, we have a surplus of  $3.5 \text{ kg} - 2 \text{ kg} = 1.5 \text{ kg}$  secondary metal X, for which the system gets the respective credit of avoided primary production. As the recycled metal and the credits are part of the production of the table, in the end the first use of the tables carries 25 % of the inventory and the further (i.e. second) use 75 %, plus each of them any specific activities during their use such as cleaning etc.

Note that if instead of the functional equivalent (i.e. table years of use) the market value correction would be used, it can be assumed that the first use of the table would carry a higher share of the overall inventory, as a 5 year old table would probably be sold for less than 75 % of its original price. This illustrates that it is important to aim at depicting the actually replaced quantity of the function, instead of using the value correction; any lack of accuracy from the value correction would need to be considered in the interpretation.

Note also that this is also an example of joint production, of the two uses of the table.

The example also illustrates that for cases of "further use" it is necessary to consider the full cycle, here up to recycling back to the originally produced material, along all the uses that the original material may have (as far as quantitatively relevant). The recyclability substitution approach then simply calculates the inventory per functional unit (here: 20 years table use) and that the different uses of the table (here: 5 years restaurant, 15 years other uses) carry the same inventory per unit of function (here: per year of use).

What if the end-of-life of the table after its second use would result in very different use (e.g. the metal would be powdered and used as some polymer filler), i.e. there is no link back to the original table production: the table would get a credit of avoided production of the superseded alternative filler. The table production would be modelled entirely from primary produced metal as the system is an open-loop system, i.e. does not return secondary metal. The two uses of the table share the inventory in the same ratio as above, per functional unit, here per year of useful life.

---

<sup>237</sup> Applicable in a growing, stable or slightly declining market.



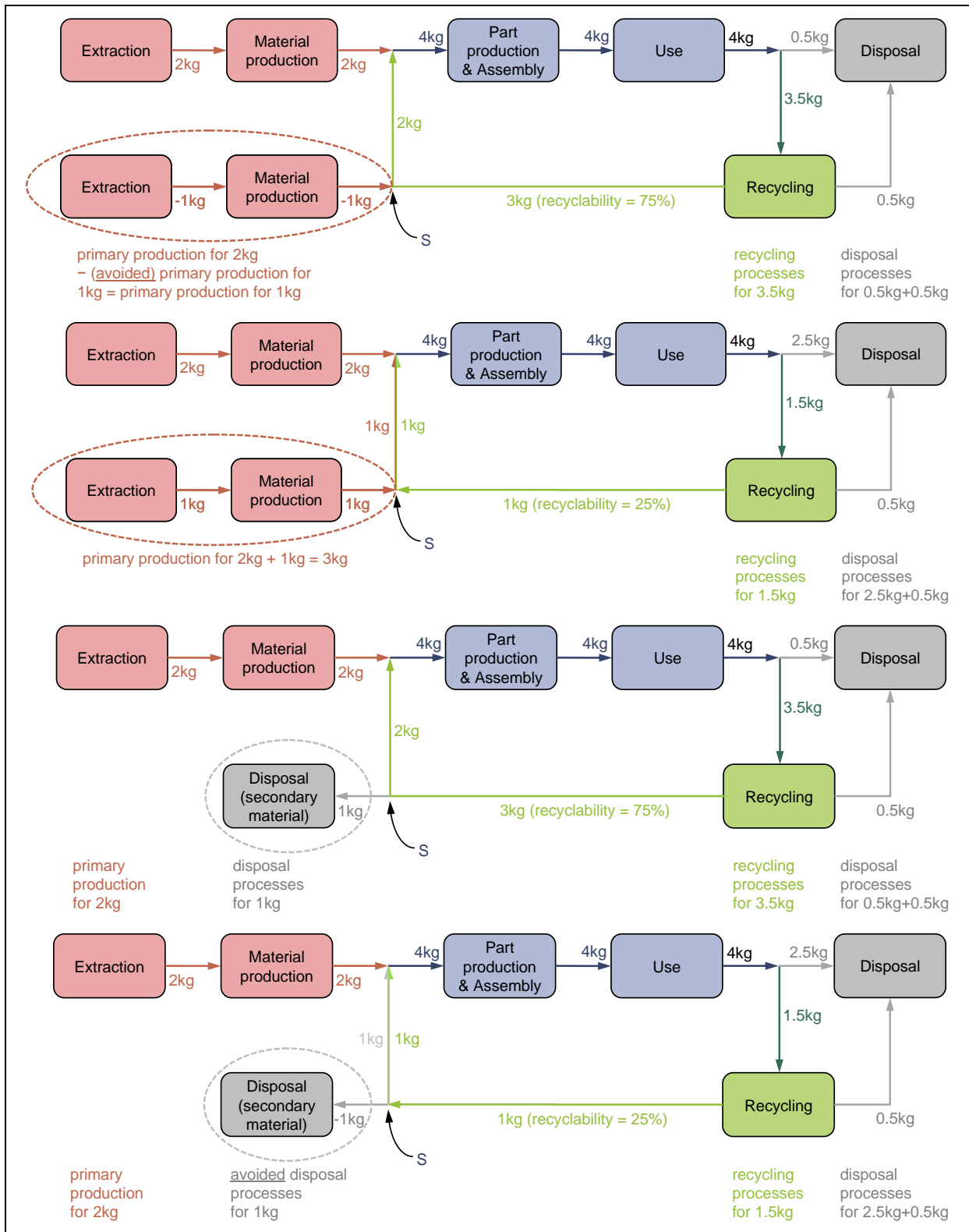

**Figure 34 Recyclability substitution approach. Explanations see "Terms and concepts" box and text. Note that this applies analogously to reuse and recovery processes.**

## 14.5.3 Detailed aspects of using the recyclability substitution approach of consequential modelling

(Refers to aspect of ISO 14044:2006 chapter 4.3.4.3)

### 14.5.3.1 Introduction

(Refers to aspect of ISO 14044:2006 chapter 4.3.4.3)

The recyclability substitution approach is especially suitable for “closed loop” and “open loop – same primary route” cases and where the secondary good enters the same system somewhere else in the background system (e.g. electricity from waste incineration). However, also if the secondary good is of a different kind as the primary good (i.e. in open loop - different primary route situations), analogous results are achieved by crediting the respectively superseded mix of other processes / systems.

For closed loop cases, this approach can also be interpreted / understood as a (product) system wide, average internal recycling loop, with any surplus of secondary goods provided (compared to the recycled content of the recycled end-of-life product or waste) resulting in additional credits for avoided primary production and any reduced provision of secondary goods resulting in additionally modelled primary production.

It also applies if the secondary good has a lower quality than its primary route delivers (as can be the case e.g. for recycling of post-consumer plastic waste). In that case, the change in functional equivalence between the secondary good and the superseded product is considered.

Four aspects need attention in this context when applying the recyclability substitution approach:

- The way how the recyclability is defined/measured,
- changes in the inherent properties of the secondary good,
- identifying the superseded process(es), and
- time aspects in “delayed” recycling of long-living products.

Note that in analogy to delayed Climate change relevant emissions from other processes (see chapter 7.4.3.7.3), also delayed Climate change relevant emissions and credited future avoided burdens from recyclings should be considered in the inventory. However, in calculating the results and interpretation, the storage and delayed emissions are only considered if a discounting of climate change / radiative forcing is explicitly foreseen as part of the goal definition of the study; per default this is not considered, since the LCA approach per default is not discounting impacts over time.

These issues are addressed in the following subchapters:

### 14.5.3.2 Determining recyclability

(Refers to aspect of ISO 14044:2006 chapter 4.3.4.3)

Under recyclability in the sense as required for use in the recyclability substitution approach, the term is to integrate all losses that occur for whatever reason. This covers all process from the point when the waste is generated or the end-of-life product is reaching the end of its useful life to the point of the produced secondary good. This includes e.g. loss due to incomplete collection, sorting, recovery, during recycling processing, rejection, etc. In short, the recyclability is the % of the primary good's amount in the waste or end-of-life product that can be found in the secondary good(s).

Both average numbers for a material can be of interest and product-specific recyclabilities (e.g. 85 % average recyclability of material X in Europe, or 70 % specific recyclability of material X from product Y); this depends on the study.

Note that for different materials, parts etc. that are reused/recycled/recovered from complex products, these calculations need to be done separately for each secondary material, part, etc. (e.g. copper and PVC from cable recycling).

For practical reasons and for long-living products the recyclability should per convention be the currently achieved recyclability for this product (or for new/projected products of comparable products in the same market). This is unless the study would explicitly look at the effect of different recyclability scenarios e.g. in design-for-recycling studies.

### 14.5.3.3 Changes of inherent technical properties of the secondary good

(Refers to aspect of ISO 14044:2006 chapter 4.3.4.3.2)

The technical properties of a material or part can be unfavourably changed in the refurbishing, recycling or recovery process (e.g. shortening of fibres in paper recycling, greyish colour and less good processing properties of recycled polymers due to limited sorting specificity and remaining content of additives, fillers etc., shortened lifetime of a reused mechanical motor part, etc.). This “down-cycling” can mean that the secondary good cannot replace the primary produced material or part, or only in certain applications. In addition or alternatively this can mean that the secondary good can replace it only after additional measures have been performed, and/or to a limited degree, or for a limited duration (e.g. due to a reduced lifetime of a reused part). For those e.g. materials that degrade during use and recycling, this puts a limit to the number of cycles that they can go through, also independently from any quantitative losses that occur.

There is a range of specific consequences and corresponding solutions to address this “down-cycling”, that need a closer view: In some cases, the secondary good can only replace the primary produced material or part in some of the applications, where the requirements to the changed property are not too demanding. In other cases, a higher amount of the recycled material is needed than of the virgin material, in order to provide the same functionality (e.g. stiffness of a polymer part)<sup>238</sup>. In again other cases, the down-cycled secondary material is to be mixed with primary material or higher quality secondary material to meet the minimum technical specifications. On the other hand, the effect of downcycling may be substantially counteracted by special technologies: these may be able e.g. remove a too high amount of tramp elements from steel. Or e.g. subsequent purification steps are applied to recovered solvents.

In summary: The changed properties of the potentially down-cycled secondary good and the consequences in its use must be considered when modelling the substitution.

This is done by two mechanisms: if the specific use or uses of the secondary good are known, the actually replaced amounts of the superseded process(es) / system(s) are

---

<sup>238</sup> Note however that: this is a different issue that is not to be explicitly considered here as it is implicitly already covered via a lower market price.

modelled. If the uses or amounts are not known, “value correction”<sup>239</sup> is applied, i.e. by using the market-price ratio of the secondary good to the superseded primary produced good, crediting an accordingly reduced amount of the primary material inventory. Two examples are given to illustrate this value correction, one for “closed loop” or “open loop – same primary route” recycling and one for “open-loop - different primary route”:

If e.g. for a polymer-based product of 0.2 kg weight, the recycled polymer granulate may have a market price of e.g. 0.9 US\$ / kg. The primary material granulate that is replaced in the same (or different) product may cost 1.2 US\$. In that case only  $0.9/1.2 = 0.75$  shares (i.e. 75 %) of the 0.2 kg, i.e. 0.15 kg, primary polymer would be substituted (“credited”).

An example of “open loop - different primary route” recycling, involving energy-recovery: For another polymer-based product of 0.2 kg weight, the recycled polymer might due to e.g. material-degrading after long-time use or due to soiling etc. only be used for energy recovery. The secondary good would in that case be the e.g. 0.28 kWh<sup>240</sup> electricity generated from the incinerated plastic waste that is fed into the grid. This electricity is technically equivalent but also be assumed to have the same market price as the average large producer electricity price of e.g. 0.04 Euro per kWh. In consequence, the full<sup>241</sup> 0.28 kWh primary produced electricity would be substituted (“credited”). Under full consequential modelling, the superseded electricity would be the mix of the most<sup>242</sup> cost-competitive technologies of the electricity market / country where the recycling takes place (but see the simplifications for Situation A, B, and C1).

The next text-sections will show that this approach is reasonable also for very different reasons:

#### 14.5.3.4 Identifying superseded processes in line with market consequences to consider

(Refers to aspect of ISO 14044:2006 chapter 4.3.4.3)

It is often argued, that the life cycle model should give the correct incentives for more and better recycling, if there is a high demand for this secondary good or for higher quality. At the same time it should give an incentive for more use of the secondary good, if there is little demand for it. For meeting these requirements, two different perspectives can be taken to identify the superseded process(es): firstly the consequential approach of identifying the superseded processes / systems. Secondly the perspective looking at how to steer the waste

<sup>239</sup> Another and more specific approach discussed is to use the changes in the relevant specific technical properties as corrector. While this would allow using a correction-factor that closer relates to the technical properties, it has a number of shortcomings: 1) It involves subjective choices on which technical property to use for correction. This lowers the reproducibility, even more so as often several properties are affected that only jointly define the technical usability/value of a secondary good. These properties cannot simply be added up, as they are measured in all kinds of different units. Also, some properties may be qualitative (e.g. mixed and dark colours of secondary goods). 2) The technical properties do not reflect the important question, whether there is a real market for the secondary good or not, as e.g. perception („waste image“, „green image“) plays an important role as well. 3) The necessary technical information is typically more difficult to collect or measure than are the market prices.

<sup>240</sup> The number is illustrative and approximate only: 0.2 kg e.g. PP has roughly 10 MJ lower calorific value energy content. At 10% conversion efficiency of the waste incineration plant to electricity (considering the internal consumption for off-gas cleaning etc.) 1 MJ electricity, i.e.  $1 \text{ [MJ]} / 3.6 \text{ [kWh/MJ]} = \text{ca. } 0.28 \text{ kWh}$  remain.

<sup>241</sup> While 100% of the produced electricity is credited, the absolute environmental benefit that is credited is clearly lower than crediting the use of replacing the 0.15 kg primary PP of the preceding example.

<sup>242</sup> “Most” cost-competitive if the market is “growing, stable, or slightly declining”, as assumed in case of this electricity market.

/ end-of-life product situation towards an overall improvement, i.e. reduction of impacts. The following paragraphs look at the same question from these two perspectives:

### Consequential modelling perspective

In consequential modelling, considering the two cases of "growing, stable, or slightly declining" markets and of "strongly declining" markets, and deriving the most likely superseded processes, the following would be modelled:

- Additional supply of the secondary good, as surplus from recycling (i.e. more secondary good generated than used in the product's production):
  - For "growing, stable, or slightly declining" markets, the additionally available amount of the secondary good would supersede the mix of the most cost-competitive primary production process(es) of the same material, energy, or part.
  - In "strongly declining" markets, the additionally available secondary good could be argued to not be used at all. However, the way the recyclability is defined here, i.e. capturing the actual availability and use of the secondary good in the market, it is *de facto* used and is to be credited as well. It will supersede in this case the mix of the least cost-competitive processes / systems. If the secondary good is at least partly un-used (i.e. deposited)<sup>243</sup>, any additional supply would directly go to waste depositing, as the market is already saturated/over-supplied. Accordingly, no credit is given, but waste depositing is modelled.
- Additional demand for the secondary good: An additional demand for the secondary good occurs, if the amount of secondary good that is generated by recycling is smaller than the amount that is used in the product's production:
  - In "growing, stable, or slightly declining" markets again the most cost-competitive processes / systems would be affected, in this case the production of the lacking amount is modelled as additional primary production inventory. If this additional demand relates to an at least partly un-used (i.e. deposited) secondary good, the avoided waste treatment of the otherwise not used secondary good is credited.
  - Finally, in "strongly declining" markets, the additionally demanded secondary good would supersede again the mix of the least cost-competitive processes / systems. If the secondary good is at least partly un-used (i.e. deposited), any additional demand would avoid the waste deposition of the same secondary good that is produced from other waste or end-of-life products. Accordingly, a credit for avoided waste depositing is given.

The specifically superseded amount of primary good or the relative market value of the secondary good vs. the replaced good is used to reflect the reduced technical properties of the secondary good. If this information is lacking, market-value correction is done.

---

<sup>243</sup> This is indicated by a market value of below zero, while still it is used in some application. Note that the value is below zero and not "zero or below", as the waste depositing has a cost (i.e. a gate fee is to be paid). That means that it is not automatically clear from the market price alone whether a secondary good is at least partly deposited. This is exactly then the case if the negative market value equals the waste fee. These fees differ considerably among countries globally and also for the type of waste to be deposited; they are roughly in the range of -0.005 US\$ and -0.5 US\$ per kg.

## Perspective of creating Incentives for increased recyclability vs. increased use of secondary goods

In markets that are growing or where for other reasons (e.g. “green image”) the demand for a secondary good is higher than the amount that is available via recycling/reuse/recovery (e.g. in most but not all current material markets), the main necessity is obviously to increase the recycling rate (i.e. recyclability) and not the demand for recycled materials (i.e. recycled content).

A comparatively high market price of the secondary good compared to the price of the same primary good means at least one of the following:

- the market is growing AND the recycled material is of sufficient / high quality and/or
- there is demand for the secondary good for other reasons (e.g. positive “green” perception)

In consequence, mainly the quantitative extent of reuse/recycling/recovery needs to be promoted, i.e. the recyclability. This is what the approach “recyclability substitution” does.

A comparatively low price of the secondary good (compared to the one of the primary produced good) indicates at least one of the following:

- there is a high recycling rate for some reason that provides an excess of the secondary good, and/or
- the achieved technical quality of the secondary good is low (in view of the required minimum quality for most applications; this is typical for down-cycling in open loop), and/or
- there is a limited demand for the secondary good for other reasons (e.g. “waste-image” perception, hygiene legislation, etc.).

If the amount that is available via reuse/recycling/recovery is higher than the demand, and the market value is accordingly below zero, the main necessity is to increase the demand for the secondary good (i.e. recycled content) and/or its technical quality (i.e. high-quality recyclability), but not the simple recycling rate (i.e. general recyclability).

That situation seems to call for either using the recycled content approach, or for only considering high-value recyclability, or overcoming the obstacles/constraints of e.g. hygiene legislation. This however would need a deeper investigation of identifying the underlying causes while a generally applicable, reproducible calculation rule is required here that still provides the right incentives. Is the recyclability substitution providing this solution?:

The recyclability substitution considers the reduced technical properties, i.e. how much of which alternative primary good the secondary good is able to replace. Or it considers this via value correction. In both cases, for producing low quality / low value or even value-less secondary goods, a lower credit is given. The value-corrected credit reflects hence both the amount and quality of the secondary good, stimulating higher quality recycling or other measures that effectively overcome other existing obstacles to use the secondary goods (e.g. overcoming waste image, changing legislation, etc.).

If the additional supply of secondary good is just ending in a waste deposit, no credit is given, but waste depositing is modelled.

If the analysed system uses otherwise deposited secondary goods, the recyclability substitution approach gives a clear incentive to do so, as avoided waste depositing is credited - the more is used as recycled content and the more problematic the waste's deposit behaviour is, the more credit is given. In such cases, a higher recycled content is rewarded

and stimulated. This stimulation is proportionally stronger, the lower technical quality / value the secondary good has.

### Conclusion

The recyclability substitution approach with value correction and considering the supply/demand of otherwise deposited secondary goods yields the right incentives for both stimulating quantity and quality of recyclability and use of secondary goods, as required in the respective situation.

#### 14.5.3.5 Time aspects in “delayed” recycling of long-living products

(Refers to aspect of ISO 14044:2006 chapters 4.3.4.3, 4.2.3.5, 4.2.3.6.2 and 4.3.2.1)

If carbon storage and delayed emissions are considered in an LCA study, the following applies:

In line of the 100 years time-horizon of inventory data collection and Climate change impact modelling, the question arises, how to account for the delayed/future benefits of providing recyclable long-living products to future generations. For the question of biogenic and fossil delayed emissions of greenhouse gases, the same question was answered by using a special flow that keeps the information of the delay of up to 100 years in the inventory.

Using the same approach, future recycling is to be modelled by using a correction flow for greenhouse gases related to recycling operations and equally for the credits of future reuse/recycling/recovery. This is done by using the same correction flows, so that the full information is kept.

However, as LCA in general has an infinite time-horizon, by default this correction flows are not considered when calculating the results. If radiative forcing is explicitly meant to be discounted to zero over 100 years from the time of the study, this is to be explicit part of the goal definition. This means that only in that case the avoided future emissions of CO<sub>2</sub>, CH<sub>4</sub> and N<sub>2</sub>O for avoided primary production of e.g. copper from cables, calculated using the recyclability substitution approach, would be scaled down for a product with a life-time of 10 years (e.g. a car) by 10 % (i.e. 10 years / 100 years).

Note: the Provisions of this annex are found in the main text, in chapter 7.2.4.6; but observe the specific simplified provisions made for Situation A, B, and C1 in chapters 6.5.4.2 and 6.5.4.3.





# 15 Annex D: Avoiding misleading goal and scope definition and results interpretation

(No corresponding ISO chapter but referring to a number of chapters)

## 15.1 Introduction and overview

(No corresponding ISO chapter but referring to a number of chapters)

Sometimes, elements of the goal and scope definition are, possibly inadvertently, performed in a way that leads to misleading results. Or the results of an LCA are interpreted in a way that is not in accordance with the goal of the study or the way the analysis was scoped, and this again leads to misleading conclusions<sup>244</sup>.

This appendix identifies types of errors that are made in the goal and scope definition and in the interpretation of an LCA study that can lead to misleading results and conclusions. It hence guides towards non-misleading goal and scope definition and results interpretation.

## 15.2 Misleading goal definition and scoping

(No corresponding ISO chapter but referring to a number of chapters)

The goal definition defines the decision-context of the study, identifies the intended applications of the results, and names the targeted audiences.

The scoping of the study is done in accordance with the goal definition, and the interpretation must also respect the goal definition.

The goal definition itself might be not misleading. It can however state something else than what is truly the goal of the LCA but if the scoping, the LCI and LCIA work is done in accordance with the stated goal, the misleading only occurs when the results of the LCA are interpreted according to the true goal rather than the defined goal. This is an error that occurs during the interpretation and is discussed there. In other cases also the interpretation of the results may be correct, but the results that may build on very specific goals are condensed in a way that leads the reader to misunderstand and misinterpret or generalise the factually very limited recommendations. In this sense, also the definition of goals needs guidance to avoid it can be the basis for misleading results interpretation.

The goal definition must hence be very clear on:

- the comparative character of the LCA study (e.g. “Comparison of the environmental impacts associated with fuel-type A and fuel-type B for use in private cars in Country X”) and if assertions about environmental superiority or equality are made and these are foreseen to be published,
- the reasons to carry out the study, including the decision-context (e.g. “Support governmental decisions on the introduction of new fuel-types for private cars in Country X”),
- who commissioned the study (e.g. “The National Ministry for Transportation in Country X”), and

---

<sup>244</sup> After the goal definition and scoping, another main source of misleading results lays in the inventory and impact assessment phases: this is when the goal and scope settings are implemented in a deviating way. This is however not an issue of misleading goal and scope definition and results interpretation, but of incorrect LCI and LCIA work in general and not further discussed here.

- the target audience of the study, especially whether these have technical knowledge or LCA knowledge

Furthermore are goals to be avoided that

- analyse highly specific and uncommon e.g. product use case scenarios, comparing a product A exclusively with an outdated, highly inefficient and polluting alternative product B with the purpose to later demonstrate and communicate to the public the “environmental superiority of product A”. This is misleading if products C, D, etc. would be in the market, having a better environmental performance than A.

Several aspects of the scope definition present a risk of errors that can lead to misleading results. Important examples are given in the following sections

## 15.2.1 Functional unit

(No corresponding ISO chapter but referring to a number of chapters)

### Failing to base comparisons on a valid functional unit:

In the cases where the LCA is intended for comparison of two or more products or systems, the functional unit must give an unambiguous definition of the service or function that the compared products must provide. Based on this definition the reference flows of the products can be determined. When the functional unit does not reflect the service provided or the reference flows are not based on a functional unit, seriously misleading results may occur. Examples are:

- The chassis of a television set can be made from plastic type A, from metal M or from bio-based material B. In order to decide which of the three solutions has the lowest environmental impacts, the material impact profiles are compared for one kg of each material. This is a misleading choice of reference flow since the weight of material required to construct the chassis differs between the three materials. The correct reference flows should be derived from the functional unit (in this case one television set) and would for each material reflect the quantity applied in producing the chassis of same technical quality (e.g. mechanic stability, durability, etc.). It is rarely appropriate to compare materials on an equal weight basis.
- A study is intended to guide the choice between refillable bottles of material A and one-way beverage cartons of material B for distribution of milk to households. An LCA is performed for one bottle and one beverage carton. This is a misleading choice of reference flow since it ignores the fact that on average the refillable bottle is returned and reused to give a total of e.g. 25 use situations while the beverage carton is used only once. At the same time would this ignore among others the need for return transport, cleaning, etc. of the bottles and the benefit of e.g. recycling and/or energy-recovery of both products after their use. Again, the relevant reference flows should be derived from a correct functional unit, which might be “Packaging 1000 litres of fresh milk in 1 l containers that may serve for distribution and storage of the milk in the chain from dairy to the private household”. With this functional unit the relevant basis of comparison would be reference flows of e.g. 1000 beverage cartons and 40 bottles<sup>245</sup>.
- In a comparison of two farming methods, the impacts from cultivating one hectare with wheat are compared. This is a misleading choice of functional unit if the results are

<sup>245</sup> Note that in addition other functional aspects would need to be considered such as comfort, shelf-life, protection from light or from smell of the fridge, etc.

used to support comparison of the products in which the wheat is applied: it ignores e.g. the fact that the yields will often differ between different farming methods. Quality differences of the wheat may additionally need to be considered. The correct functional unit should specify the amount of products to be compared, not the area cropped.

## 15.2.2 Modelling principle

(No corresponding ISO chapter but referring to a number of chapters)

### **Failing to choose the proper LCI modelling principle and associated approaches**

The choice of modelling principle - attributional or consequential - decides whether the technologies to be covered by the collected unit process data in the inventory analysis should reflect the average technology for a given region and time-period or rather the marginal technology that is increased or decreased in use as consequence of the studied decision.

The decision-context of the goal of the LCA determines the appropriate LCI modelling principle and method approach to be applied. Considering other issues such as reproducibility and robustness the practical guidance of this guidance document was derived.

The difference between the marginal and the average can be large for some technologies. In the case of electricity generation, the marginal technology can be coal-fired power or wind-power, while the average technology will typically look very different.

For products or systems that use much electricity, the single choice of electricity technology (mix) will often be decisive for the overall results and the wrong choice of modelling principle will then give misleading results. The same issue applies to all kinds of processes and is hence one of the most outstanding methodological choices in LCA.

## 15.2.3 Drawing of system boundaries

(No corresponding ISO chapter but referring to a number of chapters)

### **Leaving out activities or whole life cycle stages that are environmentally relevant**

The iterative procedure applied in LCA is intended to assure that the important processes and activities are included in the inventory analysis. That means that the system boundaries are drawn so only things of minor importance are left out, and that the data quality is sufficiently strong for the most important processes to ensure robust results for the intended applications.

Misleading results may occur when system boundaries are drawn in a way that important processes are excluded e.g. due to:

- Use of too weak or irrelevant cut-off criteria (e.g. limited to mass and energy), when the chosen cut-off criteria are not in accordance with the requirements given by the intended application. Or when cut-off criteria are set on single elementary flows without consideration of their individual environmental impacts. The latter is particularly a problem for the chemical-related impact categories addressing human toxicity and ecotoxicity, where elementary flows can have characterisation factors that differ by many orders of magnitude.
- Lack of proper screening and iterative approach causing the practitioner to focus on the wrong processes in the data collection of the inventory and miss the most important processes.

- Systematic exclusion of activities that play a quantitative role without checking whether this is justified by their insignificant contribution to the overall impacts – e.g. a priori decide to exclude:
  - the production of capital goods
  - services ( e.g. “retailing” when comparing frozen/non-frozen food, “maintenance” when comparing sensitive equipment, “transportation” or “storage” of products
  - consumption of auxiliary materials (e.g. lubricants, detergents, etc.)
  - waste treatment (e.g. wrongly considering them as appropriate inventory flows or assuming their irrelevance).
- Systematic exclusion of complete life cycle stages due to missing insight of their relevance for the compared products (see e.g. the example on beverage boxes vs. bottles where reuse and end-of-life were wrongly ignored to be of relevance). An example: In a comparison study of reusable cotton diapers and one-use diapers it would thus be misleading if one or more of the following elements were omitted from the system scope:
  - End-of-life of reusable diapers (also reusable products must be disposed of)
  - Retail and shopping of many single-use diapers vs. one reusable diaper
  - Auxiliary materials, e.g.
    - Detergent for washing of reusable diapers
    - Packaging for single-use diapers
    - Special pants for reusable diapers, worn to ensure comfort
    - ...

## 15.2.4 Choice of LCIA impact categories, LCIA methods, normalisation and weighting sets

(No corresponding ISO chapter but referring to a number of chapters)

### Limitations in coverage of environmental impacts

The selection of impact categories must be consistent with the goal of the study and the intended applications of the results, and it must be comprehensive in the sense that it covers all the main environmental issues related to the system. If the goal definition does not specifically limit the scope of impacts to be covered (e.g. by defining the study as a carbon footprint study or an analysis of the energy flows in the life cycle), serious misleading may occur by omitting some of the impacts that the system has. This is in particular when two technologies that differ in their pattern of environmental impacts are being compared.

Take as an example high pressure cleaners A and B that both use electricity and water in the use stage. Cleaner B also applies detergents in the water stream and thereby provides the cleaning function specified in the functional unit with smaller use of water and energy. The use of detergents also leads to impacts in their production and use stage. An LCA that only focuses on the water and energy use will be in the favour of cleaner B but the results can be misleading if the detergent-related impacts are important.

## Selection of specific LCIA methods and normalisation and weighting sets

The LCIA methods (and any normalisation or weighting factors) are to be identified in the scope definition and this decision is to be documented. Misleading results may intentionally be created by changing the choice of LCIA methods and normalisation or weighting factors after seeing the results of the impact assessment.

If sub-subsequent changes would be made, LCIA factors could be chosen that give the most positive results for the commissioner's own product.

## 15.2.5 Representativeness of data

(No corresponding ISO chapter but referring to a number of chapters)

Representativeness is the ability of the inventory data to describe the emissions and environmental impacts of the system. It depends on how well the inventory data represent the process for which they are collected and how well that process represents the process of the system that is modelled. Good representativeness is particularly important for the most important processes of the system.

Representativeness has three components – technological -, geographical – and time-related representativeness, which interrelate and are all to be considered and met by the used data.

### 15.2.5.1 Technological representativeness

(No corresponding ISO chapter but referring to a number of chapters)

#### Poor or distorted technological representativeness for key processes

The data used to represent the key processes of the system must be representative in terms of their technology to ensure that the data has the sufficient technological accuracy. Different technologies may result in identical products (e.g. diesel fuel), but the processing steps including the raw material bases e.g. may differ completely (e.g. biomass-based synthetic diesel vs. crude-oil based diesel). The use of data that lacks the correct technological representativeness can often be as wrong as using data from a completely different product.

In addition and especially for comparative assertions a balanced representativeness is crucial. This is illustrated in two examples:

- In a comparative LCA study commissioned by company A who wants their food packaging produced from plastic X compared to a competing product produced from metal Y. The consultant performing the study receives specific data for all of company A's own processes and the company supports the procurement of specific data from all of the main suppliers involved in the product chain. For the competing product, company A and its consultant have no specific information and the consultant is obliged to rely on generic data from third party databases for all key processes. The result is an (unintended) distorted technological representativeness that poses a great risk of misleading results.
- In a comparative LCA study of vehicle fuel production technologies, the current very widespread technology A is compared to the planned new technology B, which at this point is still only working in laboratory scale. Using the available data for the two technologies leads to a distorted technological representativeness for the future situation, as the development and maturation levels of the technologies are not the same. Assuming the yields and efficiencies observed today in lab scale to be directly representative for the future commercial scale situation is not reasonable and some sort

of extrapolation is required but must be done with caution to avoid a misleading bias in the technological representativeness. This case is closely linked to time-related representativeness (see Section 15.2.5.3)

### 15.2.5.2 Geographical representativeness

(No corresponding ISO chapter but referring to a number of chapters)

#### **Poor or distorted geographical representativeness**

The data used for the key processes must also be representative in terms of their geographical origin and coverage. The LCA practitioner performing the study must identify key processes and key assumptions that vary according to the geographical location and ensure the proper geographical representativeness for these.

Geographical representativeness and technological representativeness are often related in the sense that poor geographical representativeness means that the applied data represents a different technology (mix) from what is applied in the system.

Similarly as using data from a different technology route, also using data from different regions can lead to completely wrong results, as big differences in the inventories may exist.

### 15.2.5.3 Time-related representativeness

(No corresponding ISO chapter but referring to a number of chapters)

#### **Poor or distorted time-related representativeness for key processes:**

The data used for the key processes must also be representative in terms of their time-related origin (age). Again, there is a close relation to technological representativeness; as technology is developed and changed over time, a poor time-related representativeness often also means a poor technological representativeness. This is especially the case for fast developing technologies, e.g. in ITC systems, renewable energy systems, services, and the like. For basic materials and energy carriers these changes are much slower. Data sets should therefore inform about the validity (“expiry date”) of its inventory.

Two examples:

- In the above comparison of company A’s plastic-based food packaging with the food packaging produced from metal Y, quoted in Section 15.2.5.1, part of the distortion in the representativeness of the applied data resides in a distorted time-related representativeness: The data of company A’s own production and supply chain is quite recent and represents the current state of operation for all its own processes and data for suppliers is also recent. In contrast, the data for the competing food packaging is retrieved from databases or literature and as such typically at some years old, some of it potentially much older. This bias in the time-related representativeness is followed by a further bias in technological representativeness due to the typical development of technology, typically to the advantage of the food packaging from company A.
- In the identification of focus points and design recommendations for ecodesign of a refrigerator to be sold, used, and disposed off in Region X, an LCA is performed to find the hotspots of the life cycle. The refrigerator may be expected to have a lifetime of 15 years. In order to avoid misleading results on the impacts of the end-of-life, the data for the disposal and material recycling processes in Region X should be forecasted or at least taken from the present best available technology (BAT). This is to represent the most probable situation when the refrigerator ends its functional life. Again, the time-related representativeness is closely related to technological representativeness through the development of technology in time.

## 15.2.6 Consistency in comparison of systems and products

(No corresponding ISO chapter but referring to a number of chapters)

### Inconsistent scoping of systems in comparative LCAs

In order to avoid misleading results, it is important that the scoping is done consistently for the different parts of the system, or for the different systems in case of comparative LCAs. In particular in the case of comparative LCAs, inconsistent treatment of any of the scoping aspects covered by Sections 15.2.1-15.2.5 can easily lead to misleading results and conclusions,

- if the compared products A and B do not provide the same functionalities due to an inappropriate definition of the functional unit,
- if different modelling principles are applied in the analysis of the compared products A and B and e.g. marginal technologies used for key processes in the life cycle of product A while average technologies are assumed for the corresponding processes in the life cycle of product B (which is in addition also an example of inconsistent technological representativeness),
- if the system boundaries are drawn in an inconsistent way, or
- if the representativeness (technological, geographical or time-related) of the data differs relevantly for some of the key processes in the life cycle of products A and B.

## 15.3 Misleading interpretation

(No corresponding ISO chapter but referring to a number of chapters)

### Introduction

In the interpretation phase the results of the LCA study are appraised and interpreted in order to answer the questions posed as part of the goal definition or by the intended applications of the study. The outcome of the interpretation are be conclusions or recommendations that are to respect the intentions and restrictions of the goal and scope definition of the study and also take into account the appropriateness of the functional unit and system boundaries in relation to the goal. The interpretation must thus be closely linked to the goal which was defined in the beginning of the study and respect the limitations that the scoping puts on the validity domain of the results.

Misleading interpretation occurs when:

### Interpreting the results beyond what is supported with the chosen scope definition

An example of this form of misleading interpretation is when conclusions for specific cases (e.g. specific technology, specific use scenario, specific country) are generalised to be valid for broader cases (family of technologies, all uses, globally).

An example:

- In a comparative study of diapers the goal may be defined as “Comparison of reusable and single-use diapers in Country X”. In Country X the single-use diapers may be treated together with household waste, i.e. incinerated with recovery of the produced energy, where as the electricity used for washing the reusable diapers may be produced from stronger polluting energy sources. This specific combination may give the single-use diapers a competitive edge over multi-use diapers in Country X from an environmental point of view. If this conclusion was generalised to other countries or even the global scale, the LCA consultant performing the study would disregard

- the fact that the end-of-life of this type of product is crucial in the life cycle perspective,
- that the waste treatment of diapers in Country X is far from the situation in other countries or on a global scale where land-filling of household waste is much more common.

Generalisation of conclusions to other scopes will often be a misleading interpretation.

Another type of misleading interpretation occurs when:

### **Interpreting results beyond what they can support**

As part of the interpretation of comparative studies an analysis of the overall achieved accuracy and uncertainty should be performed, at least qualitatively. In comparative studies, the difference in environmental impacts that is found between the compared alternatives is to be judged against the appraised uncertainty of the results in order to identify whether there is any significant difference.

In the cases where the data does not support a quantitative uncertainty analysis, conclusions about superiority of one alternative over the other should still be justified by a discussion of the qualitative uncertainty of the results relative to the differences found between the alternatives and of any omissions that might change the dominance between the compared alternatives. This is to be done together with an appraisal of the accuracy of the results. An example:

- A comparison of ball point pens shows that one type has less environmental impacts than the other in all examined impact categories, leading to the claim that “Pen xx” is better for the environment than “Pen YY”. The report shows that the differences are small, e.g. less than 5 % in all impact categories examined, and no form for statistical treatment of the data has been performed in order to determine a level of significance and also the accuracy of the respective results has not been judged. The claim is thus not scientifically justified, and it is likely that the interpretation is misleading.

## **15.4 Misleading reporting and communication**

(No corresponding ISO chapter but referring to a number of chapters)

The misleading interpretation of comparisons (e.g. in the above example of single-use and multiple-use diapers) might not necessarily be done by the consultant who performs the study or the commissioner, but be left to the user of the results: This is if the highly specific findings are presented in a way, where the limitations and assumptions are put into annexes and footnotes only and are not clearly stated directly in context of the presentation of conclusions and recommendations.

Reporting and communication equally has to consider any limited technical and LCA methodological understanding of the addressees, e.g. of the general public. Conclusions and recommendations and the reference to limitations and assumption is hence to use the appropriate language and level of technicality for the target audience, ensuring that all targeted audience is appropriately informed about them.



## 15.5 Integrated example of misleading goal and scope definition and interpretation: cups for hot drinks<sup>246</sup>

(No corresponding ISO chapter but referring to a number of chapters)

### Starting point and goal definition

The old cups used for hot drinks in the canteen at a large factory in country X are worn out. Company Y that owns the factory frequently uses claims of environmental sustainability in its marketing. Before purchasing new cups, the company thus wishes to investigate which solution is preferable from an overall environmental perspective.

Company Y considers the following alternative solutions:

A.) Each employee gets personal own ceramic cup, brings it to the canteen takes it back to the work place and washes it by hand when deemed necessary

B.) The canteen buys ceramic cups which stay in the canteen where they are washed by dishwashing machine.

C.) The canteen uses single-use cups made from material Z. The cups are collected after use and treated together with household waste, i.e. transported to incinerator and burned with electricity production from the generated waste heat.

### Misleading functional unit and reference flow

In a first attempt company Y asks a consultant perform a comparison of the environmental impacts of *one ceramic cup* (alternative A and B) and *one single-use cup* (alternative C).

This is an example of misleading definition of “functional unit”: it disregards the functionality of the products that are compared. In accordance with the goal of the company and the intended application of the results an appropriate functional unit might be:

“Cup that can contain 2 dl of hot beverage (tea, coffee, bouillon) three times per day in one year (200 working days) for 1000 employees and serve as a drinking device”.

With this functional unit the relevant reference flows would be 1000 ceramic cups for alternative A and B (assuming that the ceramic cups have the same average lifetime of 1 year for both use scenarios) and  $6 \cdot 10^5$  single-use cups for alternative C, i.e. one ceramic cup versus 600 single use cups.

### Misleading drawing of system boundaries

Based on feedback from an involved supplier, the consultant realizes that in a comparative LCA it must be consistent in the drawing of system boundaries and since there are no impacts in the use stage of the single-use cup it decides to omit the use stage for all three alternatives from the study.

This is an example of leaving out life cycle phases that are important for at least one of the compared alternatives: With the frequent washing of the ceramic cups (three times per day for alternative B and perhaps 1-3 times per day for alternative A depending on the hygiene of the individual employee) and the use of hot water and detergent in the dishwashing, the use stage is probably the most important for these two alternatives.

This would have been revealed by the kind of screening based on simple calculations and easily available data or estimates that should always be carried out as a first iteration when performing an LCA.

---

<sup>246</sup> This example is of course purely illustrative and virtual, including the results and conclusions that must not be misinterpreted as having any factual basis or even detailed analysis underneath.

### **Misleading choice of impact categories**

For simplicity, company Y decides to concentrate on the carbon footprint of the three alternatives and decides to focus the data collection on the use of petrochemical fuels and feedstock in the different stages of the life cycles of the three alternatives.

This narrow choice of impact categories is not in accordance with the goal to investigate the overall environmental impacts of the three alternatives. It causes misleading results in this case since two of the alternatives have potentially important other impacts from the detergents and organic load from the washing of the cups during the use stage in country X, where wastewater is discharged directly to a river even in several of the major cities across the country. These impacts are not revealed when only carbon footprint is assessed and the study may easily result in a wrong recommendation.

Being informed about these limitations, the company decides to also include other impacts of relevance.

### **Poor and distorted technological representativeness for key processes**

Company Y has found an old study of the environmental impacts from the production of ceramic cups containing all the data needed for this part of the LCA of alternatives A and B. The production covered by the study took place in a different part of the world but the cups are of a type similar to alternative A and B. For alternative C, company Y has to contact a major producer of these single-use cups and this producer provides the required information to company Y.

Due to poor time-related and geographical representativeness of the data on the ceramic cups, also the technological representativeness must be expected to be poor. In contrast, the technological, time-related and geographical representativeness is very good for the single-use cups with data from the specific producer and supply chain of the single-use cups. This means that the representativeness of the production data is biased between the alternatives. In effect the recommendations of the study can be expected to be distorted, in this case towards favouring the alternative C.

### **Misleading interpretation**

Based on the results company Y concludes that - contrary to what they expected - the single-use cups are preferable over the ceramic cup alternatives. It turns out that even though a lot of energy resources are used to produce the many single-use cups, the energy recovery from their combustion in the end of life treatment in recently installed municipal incineration plants is rather efficient. Furthermore the canteen's dishwasher is rather old and inefficient, and in country X the electricity is mainly produced from lignite.

Overall the energy account and carbon footprint give no clear preference and the other impacts from the discharge of the untreated dishwashing water in alternatives A and B tip the balance in favour of alternative C.

Company Y concludes the superiority of single use cups and implements it in recommendations to the canteens in its factories around the world to replace ceramic cups and other tableware with single-use tableware.

This is an example of interpreting the results far beyond what is supported with the chosen scope definition. The dominance of alternative C relied among other aspects on:

- The efficient recovery of heat and generation of electricity at the waste incinerators where the cups were combusted after use and the coal-based power plants producing the electricity which is replaced by electricity from the incinerator

- The lack of treatment of wastewater which means that the contents of detergents from washing the ceramic cups is discharged untreated directly into rivers of Country X
- The inefficient dishwasher in the canteen of the factory in Country X.

If these aspects are not representative of the situation in another country, the conclusion from country X will most likely not be valid here.

**Concluding remark**

This example also shows that most errors made by the company and consultant (and the related costs of changing the study and scope of data twice in its course) could have been avoided building on LCA experience. If done properly, the results would have been valid and hence the cost be justified.



# 16 Annex E: Addressing uncertainties in LCA

## 16.1 Introduction and overview

### Introduction

Life cycle assessments are often comparative, i.e. performed in order to analyse differences between products, processes or other systems. The construction and analysis of the systems involves potential sources of uncertainties, not only in the case of future studies, but also in studies describing the present situation. In order to determine whether the apparent differences between the compared alternatives are real (statistically significant), it is necessary to perform an assessment of the uncertainties accompanying the results. The following sections give a brief presentation of some of the concepts and approaches that can be applied for addressing uncertainties in LCA

### Overview

Three main sources of uncertainty have been addressed:

- stochastic uncertainty
- choice uncertainty
- lack of knowledge of the studied system.

The stochastic uncertainties of the inventory data and LCIA methods must be considered jointly with the important choice-related uncertainties in order to determine how they propagate into the final results of the LCA.

The stochastic uncertainty of final results can be assessed in two fundamentally different ways – through an analytical solution or through simulation. Uncertainty calculation is applied to quantify stochastic parameter uncertainties of data.

Monte-Carlo Simulation is an especially suitable method to do so in LCA, as it allows varying many factors in parallel and calculating the overall resulting uncertainty on the system level. When performing Monte Carlo analysis it is recommended to consider the correlation among the various data values and impact factors if it is known.

The outcome of the stochastic uncertainty calculation should not be over-interpreted; it also may have high degree of uncertainty and especially of bias as it is not capturing systematic uncertainty and gaps in modelling and data.

## 16.2 Types and sources of uncertainty in LCA

### Overview

Uncertainties in the results of an LCA originate in

- the data that is used in the inventory analysis to represent the elementary flows for all the processes in the system
- the data that is used in the impact assessment for translating the inventory flows into environmental impact scores
- the assumptions that are made when constructing the system, (related to the representativeness of the processes that are used in the model)

- the choices that are made on central decisions like allocation key, choice impact assessment methodology or on which future developments are considered in future studies

The uncertainty of the data for elementary flows is statistic uncertainty, i.e. of a stochastic nature. The same holds true for impact assessment factors within a given impact assessment methodology, while the uncertainty introduced by the key assumptions and choices is of a different nature in that a number of discrete outcomes are possible.

### **Stochastic data**

The stochastic uncertainty of process data (like emissions and input of resources) and assessment data (like characterisation factors) means that they are adequately described in traditional statistical terms providing

- a measure of the mean,
- a measure of the variation around the mean, and
- information about the type of distribution that the data follows.

Measured data are often assumed to follow a normal distribution or a logarithmic normal distribution (in which case the logarithm of the data value follows a normal distribution). For normal distributed data, the average and the standard deviation are used to describe the mean and the variation around the mean.

### **Choices**

In contrast to the statistic uncertainty, the variation accompanying choices that are made when performing the LCA is of a discrete nature, i.e. several specific options are possible while options in between these are not. In the case of LCAs studying future situations, a number of possible and probable future settings is defined and investigated, and only these are considered relevant, not the potential futures that lie in between.

In the performance of an LCA study, there are also potentially a number of methodological choices including:

- LCI modelling principles
- LCI method approaches (and normalisation basis and weighting set, if included)
- Cut-off decisions and other system boundary settings
- Choice of LCI data sets to represent the background processes
- Choice of impact categories and LCIA methods
- Other assumptions (e.g. use of upper or lower calorific value, modelling of future processes, etc.)

Even within an LCIA methodology there may be choices to make in terms of time perspective or cultural perspective. Due to the discrete nature of the choice-related uncertainties, these are not described by a continuous statistical distribution but rather modelled as separate settings for the LCA (e.g. as distinct scenarios).

Secondly, there are the main choices that have the potential to influence the precision of the final results of the LCA. These can be significant choices are to be identified in a different way than the main contributors: by running the different possible choices as scenarios and comparing the scenario results.

## Ignorance

A third source of uncertainty is the error attributable to ignorance, i.e. the lack of knowledge about the system, leading to omission of data or incorrect assumptions about processes or elementary flows. Ignorance is related to choice uncertainty in the sense that it shows discrete behaviour but since it is not realized, it cannot be dealt with in the way that choices are dealt with. It is not handled by quantitative uncertainty assessment, but may be revealed by a qualified peer review.

## 16.3 Aggregating uncertainties over the life cycle

### Overview

The stochastic uncertainties of the inventory and assessment data must be known together with the important choice-related uncertainties in order to determine how they propagate into the final results of the LCA. For the stochastic uncertainties, the influence on the stochastic uncertainty of final results can be assessed in two fundamentally different ways – through an analytical solution or through simulation. Both require knowledge about distribution type, mean and variation for the process and assessment data.

### Analytical solution

When the inventory results are calculated disregarding the variation of the individual inventory data (i.e. just using the mean values), the result is the true mean value of final results, but this approach fails to give any information about the uncertainty of this mean. The analytical approach to meet this challenge develops an equation describing the distribution (and hence also variation) of the final results as function of the distributions of process data for all processes in the system. The analytical solution becomes a very complex expression for even a simple system but it can be approximated with a Taylor series expressing the error on the results as a function of the error on the process data for each process. Although it can be simplified in this way, the analytical approach requires qualified simplifying assumptions in order to be operational for the types of systems normally modelled in LCAs. Therefore, the simulation approach is normally applied in software used for modelling of systems

### Simulation

Simulation of the error on the total results of an LCA is typically done using a Monte Carlo approach. Each piece of inventory data is varied independently of the other inventory data around its mean following the distribution that is specified for it (type of distribution and measure of variation). A calculation of the inventory results is performed and stored, and the inventory data is varied again at random within the distributions to arrive at a new set of inventory results. The distribution of the calculated inventory results will approach the true distribution of the results when the number of calculations gets sufficiently high (often above 1000), and thus give an estimate of the variation around the mean for the final results.

In Monte Carlo simulation it is a default assumption that all processes and elementary flows are independent and hence vary independently of each other, both within the system and among the systems that are compared in a comparative LCA. This is often not the case as the processes may have a technically based mutual dependency or even be the same process occurring at different places in the system (e.g. for background processes like power production or transportation). Next to positive correlation also negative correlation occurs. Rather than independent variation, these cases may have a high degree of co-variation which will tend to either reduce or increase the variation of the final results, and it must therefore be taken into account when setting up the simulation, which is often not straight forward.

## Choice-related variation

The variation in the final results that is caused by choice-related differences must be handled by separate calculations for each combination of the identified relevant choices. Where the stochastic uncertainties can be handled and aggregated into one set of final results as described above, the choice-related variation thus leads to a number of discrete results that may be presented to the decision maker together with a specification of the underlying choices as possible outcomes of the LCA, dependent on which choices are made. In order to strengthen the decision-making support of the LCA results it is important to reduce the number of choices that are considered to the required minimum.

### A pragmatic approach

Simulation using the Monte Carlo approach relies on the information on the distribution of the individual elementary flows that are provided by the LCA practitioner. It is often a challenge to provide good information about the statistic distribution of all elementary flows for all processes in the system and this influences the quality of the statistic information provided by a Monte Carlo simulation.

Sensitivity analysis is a useful tool to identify where good basic statistic information is most needed. The processes and flows that contribute most to the final results are also the ones with the strongest potential to contribute to the uncertainty of the final results, and particularly for these key figures, it is thus crucial that the statistical information is correct.

In the absence of tools to support a Monte Carlo simulation, an analysis of the uncertainty of the final results may still be performed along this line, using a sensitivity analysis to identify the key processes, key elementary flows and key choices. For each of these, the potential variation is analysed and basically handled as discrete choices (for stochastic uncertainties as realistic worst case and realistic best case values) in a number of what-if calculations. The outcome in some cases allows an indicative answer to the question of the goal definition. In other cases the outcome is inconclusive meaning that a more detailed approach is needed in a new iteration, but then it helps focus the effort on some of the identified key data and assumptions.

The earlier mentioned "reasonably best case" and "reasonably worst case" can be formed in this way and help to quantify approximately the range of results and hence the robustness of the results interpretation.



## 17 Annex F: System boundary template

A system boundary diagram is essential to clarify which life cycle stages and processes have been included in the system model.

### Technical audience

For technical audience it makes sense to have a more formalised diagram. The system boundary template of Figure 35 is also available as MS PowerPoint™ file for free use. It contains graphical elements that represent the ecosphere, the technosphere, the main life cycle stages and sub-stages, sets of product and waste flows that enter or leave the system boundary from or to the rest of the technosphere, respectively, and sets of excluded activity types and processes that need to be explicitly listed in complementation of the diagram. Alternatively also other diagrams can be used (e.g. the one described below, that is also suitable for non-technical audience) as long as it correctly depicts the system boundary, names the first and last process step in case of incomplete life cycle models, lists quantified but not fully modelled product and waste flows, and lists excluded items.

### Non-technical audience

For non-technical audience it is equally useful to have a representation of what is included, while less formalised.

The challenge is that a system boundary diagram ideally should show all of the following: included life cycle stages, systematically excluded activity types and elementary flows, specifically excluded processes and elementary flows, and quantified but not completely modelled product and waste flows. For in-complete life cycles (e.g. cradle-to-gate) in addition the first and/or last included process step is to be identified.

Especially to show a potentially large number of excluded activity types, processes, and flows would overload such a diagram. To provide guidance on a suitable diagram for non-technical audience that is not misleading on what is included / excluded, it is suggested to combine a diagram with lists of excluded items. The description of the diagram shall state that it is schematic and incomplete (unless it would be complete, as possible e.g. in case of a single unit process). It would also refer to the lists of excluded items and state that in principle all relevant activities, processes and elementary flows are included in the life cycle model unless explicitly listed.

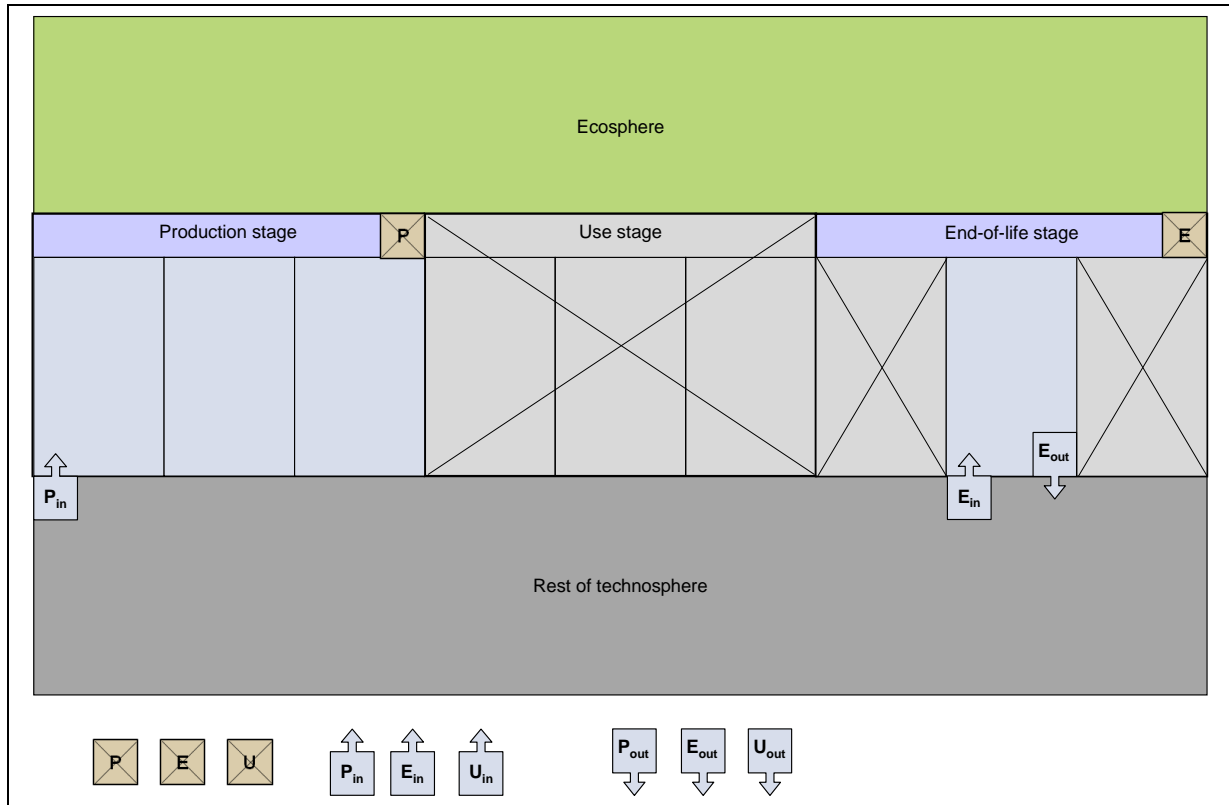

**Figure 35 System boundary diagram template for technical audience.** This example sketches a system (e.g. it could be a partly terminated system data set of an electric heater, excluding use stage but including the main recycling step). The diagram shows that the system includes the production stages up to the production of the final product plus the recycling / recovery, while excluding specific initial waste management steps (e.g. collection) and final depositing. These excluded steps would be listed separately, referring to the boxes  $E_{in}$  and  $E_{out}$ . The system also has at least one product or waste flow in the input ( $P_{in}$ ) that needs to be completed when using the data of that system. Additionally the first and last process step of the end-of-life stage would need to be named to ensure correct use of the data set when completing the system.

# 18 Annex G: Development of this document

## Based on and considering the following documents

The background document has been drafted taking into account amongst others the following existing sources:

Harmonised ISO standards

- ISO 14040: 2006 Environmental management - Life cycle assessment – Principles and framework
- ISO 14044: 2006 Environmental management - Life cycle assessment - Requirements and guidelines

A large number of LCA manuals of business associations, national LCA projects, consultants and research groups as well as scientific LCA publications have been analysed and taken into account. The detailed list is provided more below.

## Drafting

This document was initially drafted by contractors (see list below) with support under the European Commission Joint Research Centre (JRC) contract no. contract no. 383136 F1SC concerning “Development of a technical guidance handbook on Life Cycle Assessment”.

This work has been funded by the European Commission, partially supported through Commission-internal Administrative Arrangements (Nos 070402/2005/414023/G4, 070402/2006/443456/G4, 070307/2007/474521/G4, and 070307/2008/513489/G4) between DG Environment and the Joint Research Centre.

## Invited stakeholder consultations

An earlier draft version of this document has been distributed to more than 60 organisations and groups.

These include the 27 EU Member States, various European Commission (EC) services, National Life Cycle Database Initiatives outside the European Union, business associations as members of the Business Advisory Group, Life Cycle Assessment software and database developers and Life Cycle Impact Assessment method developers as members of the respective Advisory Groups, as well as other relevant institutions.

## Public consultation

A public consultation was carried out on the advanced draft guidance document from June 10, 2009 to August 31, 2009.

This included a public consultation workshop, which took place from June 29 to July 2, 2009, in Brussels.

**Disclaimer:** Involvement in the development or consultation process does not imply an agreement with or endorsement of this document.

## Overview of involved or consulted organisations and individuals

The following organisations and individuals have been consulted or provided comments, inputs and feedback during the invited or public consultations in the development of this document:

### Invited consultation

Internal EU steering committee:

- European Commission services (EC),
- European Environment Agency (EEA),
- European Committee for Standardization (CEN),
- IPP Regular Meeting Representatives of the 27 EU Member States

National database projects and international organisations:

- United Nations Environment Programme, DTIE Department (UNEP-DTIE)
- World Business Council for Sustainable Development (WBCSD)
- Brazilian Institute for Informatics in Science and Technology (IBICT)
- University of Brasilia (UnB)
- China National Institute for Standardization (CNIS)
- Sichuan University, Chengdu, China
- Japan Environmental Management Association for Industry (JEMAI)
- Research Center for Life Cycle Assessment (AIST), Japan
- SIRIM-Berhad, Malaysia
- National Metal and Material Technology Center (MTEC), Focus Center on Life Cycle Assessment and EcoProduct Development, Thailand

Advisory group members

Business advisory group members:

- Alliance for Beverage Cartons and the Environment (ACE)
- Association of Plastics Manufacturers (PlasticsEurope)
- Confederation of European Waste-to-Energy plants (CEWEP)
- European Aluminium Association
- European Automobile Manufacturers' Association (ACEA)
- European Cement Association (CEMBUREAU)
- European Confederation of Iron and Steel Industries (EUROFER)
- European Copper Institute
- European Confederation of woodworking industries (CEI-Bois)
- European Federation of Corrugated Board Manufacturers (FEFCO)
- Industrial Minerals Association Europe (IMA Europe)
- Lead Development Association International (LDAI)
- Sustainable Landfill Foundation (SLF)
- The Voice of the European Gypsum Industry (EUROGYPSUM)
- Tiles and Bricks of Europe (TBE)
- Technical Association of the European Natural Gas Industry (Marcogaz)

**Disclaimer:** Involvement in the development or consultation process does not imply an agreement with or endorsement of this document.

## LCA database and tool advisory group members:

- BRE Building Research Establishment Ltd - Watford (United Kingdom)
- CML Institute of Environmental Science, University of Leiden (The Netherlands)
- CODDE Conception, Developement Durable, Environnement (now: Bureau Veritas) - Paris (France)
- ecoinvent centre – (Switzerland)
- ENEA – Bologna (Italy)
- Forschungszentrum Karlsruhe GmbH - Eggenstein-Leopoldshafen (Germany)
- Green Delta TC GmbH – Berlin (Germany)
- Ifu Institut für Umweltinformatik GmbH – Hamburg (Germany)
- IVL Swedish Environmental Research Institute – Stockholm (Sweden)
- KCL Oy Keskuslaboratorio-Centrallaboratorium Ab – Espoo (Finland)
- LBP, University Stuttgart (Germany)
- LCA Center Denmark c/o FORCE Technology – Lyngby (Denmark)
- LEGEP Software GmbH - Dachau (Germany)
- PE International GmbH – Leinfelden-Echterdingen (Germany)
- PRé Consultants – Amersfoort (The Netherlands)
- Wuppertal Institut für Klima, Umwelt, Energie GmbH – Wuppertal (Germany)

## Life Cycle Impact Assessment advisory group members:

- CIRAIG – Montreal (Canada)
- CML Institute of Environmental Science, University of Leiden (The Netherlands)
- Ecoinvent Life Cycle Systems - Lausanne (Switzerland)
- IVL Swedish Environmental Research Institute – Stockholm (Sweden)
- PRé Consultants – Amersfoort (The Netherlands)
- LCA Center Denmark – Lyngby (Denmark)
- Musashi Institute of Technology (Japan)
- Research Center for Life Cycle Assessment (AIST) (Japan)
- U.S. Environmental Protection Agency (US EPA) (USA)

### Public consultation

Contributors providing written feedback in the public consultation ("General guide on LCA" and "Specific guide for LCI data sets")

## Organisations

- French Environment and Energy Management Agency (ADEME)
- Department for Environment, Food and Rural Affairs of the UK (DEFRA)
- Federal Office for the Environment (FOEN) Switzerland
- 2.-0 LCA Consultants (Denmark)
- Alliance for Beverage Cartons and the Environment (ACE)

**Disclaimer:** Involvement in the development or consultation process does not imply an agreement with or endorsement of this document.

- BASF AG (Germany)
- Confederation of the European Waste-to-Energy plants (CEWEP)
- Chair of Building Physics (LBP), University of Stuttgart (Germany)
- DuPont Life Cycle Group (USA)
- ESU services (Switzerland)
- European Aluminium Association (EAA)
- European Container Glass Federation (FEVE)
- Federal Office for the Environment (FOEN), Switzerland
- GreenDelta TC GmbH (Germany)
- Henkel KG (Germany)
- KCL/VTT (Finland)
- Nestle Research Centre (Switzerland)
- Norwegian University of Science and Technology (NTNU) (Norway)
- Novozymes a/s (Denmark)
- PE International GmbH (Germany)
- PlasticsEurope
- RDC Environment (Belgium)
- Stahlinstitut VDEh (Germany)
- Volkswagen AG, (Germany)

#### As citizen

- Sten-Erik Björling
- Chris Foster (EuGeos, Macclesfield, UK)
- Reinout Heijungs (CML Leiden, The Netherlands)
- Philip McKeown (Unilever, UK)
- Heinz Stichnothe (University of Manchester, UK)
- Songwon Suh (University of Michigan, USA)
- Alexander Voronov (Russia)

#### Participating in consultation workshops (written registration)

<i>SURNAME</i>	<i>Name</i>	<i>Organisation</i>
- COCKBURN	David	ACE
- RETHORE	Olivier	ADEME
- MELANIE	Rimbault	AFNOR
- RASNEUR EUROPE	Anne	AGC    FLAT    GLASS
- VAN MARCKE DE LUMMEN EUROPE	Guy	AGC    FLAT    GLASS
- CREPIAT	Ashley	Airbus

**Disclaimer:** Involvement in the development or consultation process does not imply an agreement with or endorsement of this document.

- TAHARA	Kiyotaka	AIST
- MARTIN	Michelle	ALSTOM Transport
- PAVANELLO	Romeo	Ambiente Italia srl
- JORNS	Axel	APFE – European
Reinforcement Glass Fibre Producers		
- CHIAPPINI	Mauro	ARCELORMITTAL R&D
- LIONEL	CRETEGNY	BAFU
- PIEROBON	Marianna	BASF SE
- DE LATHAUWER	Dieter	Belgian federal public
service, DG Environment		
- GOREY	Brendan	BKG
- ALLBURY	Kim	bre global ltd
- ANDERSON	Jane	bre global ltd
- VITAL	Xavier	Bureau Veritas, CODDE
- MIETH	Stephan	BV Glas e.V.
- RAMM	Kevin	Carbon trust
- XAVIER	Joppin	CELABOR
- JURY	Colin	Centre de Ressources
des Technologies pour l'Environnement (CRTE)		
- FIESCHI	Maurizio	CESISP
- FILARETO	Assunta	CEsiSP (Centro per la
sostenibilità dei prodotti)		
- VISSER	Rene	Corus Staal b.v.
- MAXWELL	Dorothy	Defra & GVSS
- HARRIS	Rocky	Department for
Environment Food and Rural Affairs		
- NOWAK	Maureen	Department for
Environment Food and Rural Affairs		
- LONGO	Sonia	Dipartimento di Ricerche
Energetiche ed Ambientali – University of Palermo		
- DANILA	Ana	EAA
- LEROY	Christian	EAA
- O'CONNELL	Adrian	EBB
- TOMOZEI	Luciana	EBB
- DR. TIKANA	Ladji	ECI
- MARTIN	Jean-Baptiste	Ecoeff
- MORENO RUIZ	Emilia	Ecoeff
- CHAUMET	Benoit	EDF R&D
- EROL	Pinar	EEA

**Disclaimer:** Involvement in the development or consultation process does not imply an agreement with or endorsement of this document.

- Toueix		ELO2
- MASONI	Paolo	ENEA
- AUMONIER	Simon	ERM LTD
- FRISCHKNECHT	Rolf	ESU-services Ltd.
- DRIELSMa	Johannes	Euromines
- SAHNOUNE	Abdelhadi	ExxonMobil
- KELCHTERMANS	Mauritz	ExxonMobil Chemical
- DEFOURNY	Anne	Federation of Enterprises
in Belgium - FEB		
- DE BEAUFORT-LANGEVELD	Angeline	FEFCO
- RIVET	Fabrice	FEVE - European
Container Glass Federation		
- DELLE SELVE	Michael	FEVE AISBL
- KANEMITSU	Hideyuki	FUJITSU
- BARRUETABEÑA	Leire	Gaiker
- DEWULF	Wim	Group T - Leuven
Engineering College		
- BRUNNER	Markus	HeidelbergCement Group
- SCHÖNE	Stefan	HeidelbergCement Group
- HEFER	Ben	Hernic Ferrochrome (Pty)
Ltd		
- TAYAH	Mira	IMA-Europe
- SCHERHAUFER	Silvia	Institute of Waste
Management, Department of Water, Atmosphere and		Environment, University of
Natural Resources and Applied Life Sciences, Vienna		
- WATAYA	Tomohisa	ISSF
- DOBON	Antonio	ITENE
- NAKANO	Katsuyuki	JEMAI
- DIEDERICHS	Stefan	Johann Heinrich von
Thünen-Institut, Federal Research Institute for Rural Areas, Forestry and Fisheries,		
Institute for Wood Technology and Wood Biology		
- BETZEL	Peter	Kreab Gavin Anderson
- FURKEL	Maxime	lexmark int.
- GONZALO PEDRERO	Gema	Ministerio de Medio
Ambiente, Medio Rural y Marino (Ministry of the environment and rural and marine		affairs")
- ARANDA MARTÍN	Desiderio	MITYC
- NURMI	Pauliina	MTT Agrifood Research
Finland		

**Disclaimer:** Involvement in the development or consultation process does not imply an agreement with or endorsement of this document.



- VERSARI	Marco	Novamont Spa
- BAITZ	Martin	PE International GmbH
- BETZ	Michael	PE International GmbH
- GUY	Castelan	PlasticsEurope
- MARECHAL	Freddy	PlasticsEurope
- DEWAELE	Joost	PROCTER & GAMBLE
- VAN HOOF	Gert	PROCTER & GAMBLE
- FLOCH	Emilie	PwC-Ecobilan
- HÉBERT	Jean-Michel	PwC-Ecobilan
- GYLLENRAM Technology, KTH	Rutger	Royal Institute of
- SIRET	Clémence	SAFT
- GOHY	Didier	Service public de Wallonie (one of the three Regions of Belgium), Département du Sol et des Déchets, Direction de la politique des Déchets (Waste policy service)
- WANG	Hongtao	Sichuan University
- KRIGSVOLL	Guri	SINTEF
- SAU SOON	Chen	SIRIM
- VLADIMIROV	Valentin	Sofia University
- SVENDING	Ola	Stora Enso
- MÜLLER	Anja	Sunicon AG
- TARISCIOTTI	Francesco	Tarisciotti
- FREDERIC	Madry	Tractebel
- ROBERTZ	Bénédicte	Umicore
- SONNEMANN	Guido	UNEP
- ANDRIÈS TRANSPORT)	Véronique	UNIFE (ALSTOM)
- MCKEOWN	Philip	Unilever PLC
- DE CAMILLIS d'Annunzio" Pescara-Chieti	Camillo	Università degli Studi "G.
- CASTANHO	Carla	University of Brasilia
- STICHNOTHE (School of Chemical Engineering and Analytical Science)	Heinz	University of Manchester
- PARISI	Maria Laura	University of Siena
- BARE	Jane	US EPA
- GEERKEN	Theo	VITO
- BOSSDORF-ZIMMER	Benjamin	Volkswagen AG
- BOUREIMA	Faycal	Vrije Universiteit Brussel
- MESSAGIE	Maarten	Vrije Universiteit Brussel

**Disclaimer:** Involvement in the development or consultation process does not imply an agreement with or endorsement of this document.

- VARES	Sirje	VTT	
- KUJANPÄÄ Center of Finland	Marjukka	VTT Technical Research	
- SOKKA Centre of Finland	Laura	VTT Technical Research	
- BENGTSSON affiliation)	Dan	(registered	without
- BOLLEN affiliation)	Jan	(registered	without
- BONAFFINI affiliation)	Davide	(registered	without
- BOVY affiliation)	Marcel	(registered	without
- CALDEIRA affiliation)	Carla	(registered	without
- HISCHIER affiliation)	Roland	(registered	without
- WEIDEMA affiliation)	Bo	(registered	without
- RICARD affiliation)	Olivier	(registered	without

#### **Contractors as members of the initial drafting team**

- Michael Hauschild, DTU and LCA Center Denmark
- Stig Olsen, DTU (Denmark)
- Anders Schmidt, FORCE technology (Denmark)

#### **Coordinators and contributors from the Joint Research Centre (JRC, IES)**

- Marc-Andree Wolf (project coordinator)
- Kirana Chomkhamsri
- Miguel Brandão
- Rana Pant
- Fulvio Ardente
- David W. Pennington
- Simone Manfredi
- Camillo de Camillis
- Małgorzata Góralczyk

**Disclaimer:** Involvement in the development or consultation process does not imply an agreement with or endorsement of this document.

## Existing provisions

The guidance document has been drafted starting from the following existing sources:

### Harmonised standards

- ISO 14040:2006 Environmental management - Life cycle assessment – Principles and framework
- ISO 14044:2006 Environmental management - Life cycle assessment - Requirements and guidelines
- CEN/TC 261 SC4 WG1 on “Packaging – LCA” and the CEN/TR 13910 “Packaging - Report on criteria and methodologies for life cycle analysis of packaging (2000)” (under revision).

### Governmental guidance documents

- BSI British Standards Institute (2008): PAS 2050 “Specification for the measurement of the embodied greenhouse gas emissions of products and services” on Carbon footprinting. And: BSI British Standards (with DEFRA and Carbon Trust) (2008). Guide to PAS 2050 - How to assess the carbon footprint of goods and services. ISBN 978-0-580-64636-2.
- AFNOR / ADEME France (2009): General principles for an environmental communication on mass market products. In series: Repository of good practices. BP X 30-323. ISSN 0335-3931. 1st issue September 2009.

### National LCA database manuals

- AusLCI and ALCAS: Guidelines for Data Development for an Australian Life Cycle Inventory Database. Committee Draft of 8th July 2008. ([http://alcas.asn.au/auslci/pmwiki/uploads/AusLCI/AUSLCI\\_Data\\_Guidelines\\_CD\\_July08.doc](http://alcas.asn.au/auslci/pmwiki/uploads/AusLCI/AUSLCI_Data_Guidelines_CD_July08.doc)).
- Danish EPA (editor): Reports of the EDIP guidelines 2003. Environmental Project No. 216.6, 862 2003, 863 2003, 70 2004.
- JEMAI (2002): Japan Environmental Management Association for Industry (JEMAI) data collection manual. 2002.
- Korea: Asia Pacific Economic Cooperation - APEC & Ministry of Commerce, Industry and Energy Republic of Korea (editors): Lee, Kun-Mo & Inaba, Atsushi: Life Cycle Assessment - Best Practices of ISO 14040 Series. February 2004.
- Swiss ecoinvent Centre (2007) - Frischknecht, R., Jungbluth, N. (editors), Althaus, H.-J.; Doka, G.; Dones, R.; Heck, T.; Hellweg, S.; Hischier, R.; Nemecek, T.; Rebitzer, G.; Spielmann, M.; Wernet, G. (authors): Ecoinvent report No. 1: Overview and Methodology for the ecoinvent database v. 2.0. Dübendorf, 2007. ([www.ecoinvent.org](http://www.ecoinvent.org)).
- NREL: U.S. LCI Database Project Development Guidelines (Final draft). Feb. 2004. NREL/SR-33806. (<http://www.nrel.gov/lci/docs/dataguidelinesfinalrpt1-13-04.doc>).

### **Methodological handbooks of industry associations**

- ACE (no year): Guideline on Liquid Packaging Board (LPB) LCI data compilation, version 1.0. Unpublished
- EUROFER (2000): European LCI Database for Coiled Flat Stainless Steel Products. Methodology Report. European Confederation of Iron and Steel Industries, Stainless Producers Group. April 2000. Unpublished.
- worldsteel/IISI (2002, 2005, 2007): Worldwide LCI Database for Industry Steel Products. Final Methodology Report of the International Iron and Steel Institute. 2002. Updated annex "IISI Recycling methodology", 2005. Plus separate methodology report "Geyer, R. & Bren, D.: Life Cycle Greenhouse Gas Emission Assessments of Automotive Materials -The Example of Mild Steel, Advanced High Strength Steel and Aluminium in Body in White Applications" on recycling modelling methods, 2007. ([www.worldsteel.org](http://www.worldsteel.org)).
- FEFCO, GEO, ECO (2006): European Database for Corrugated Board Life Cycle Studies, November 2006. (European Federation of Corrugated Board Manufacturers - FEFCO, European Association of makers of Corrugated Base Papers - GEO, European Containerboard Organisation - ECO). ([www.fefco.org](http://www.fefco.org)).
- IAI (2003): Life Cycle Assessment of Aluminium: Inventory Data for the Worldwide Primary Aluminium Industry, March 2003. ([www.world-aluminium.org](http://www.world-aluminium.org)).
- Boustead I (2005). Eco-Profiles of the European Plastics Industry. Methodology. Report for PlasticsEurope, Last revision March 2005. ([www.plasticseurope.org](http://www.plasticseurope.org)).
- DEKRA Umwelt GmbH (2008). Final draft: PlasticsEurope Eco-profiles and Environmental Declarations - Life Cycle Inventory Methodology and Product Category Rules (PCR) for Uncompounded Polymer Resins and Reactive Polymer Precursors. December 2008. Unpublished.
- Tikana L, Sievers H, Klassert A (2005). Life Cycle Assessment of Copper Products. Deutsches Kupferinstitut (DKI) and European Copper Institute (ECI). Unpublished.

### **Guidance documents in the field of Life Cycle Assessment and other scientific literature**

- Baumann, H. & Tillman, A.-M. 2004: The Hitch Hiker's Guide to LCA. ISBN: 9144023642.
- Beaufort-Langeveld, A. et al. (Eds.): SETAC Code of Life-Cycle Inventory Practice, 2001. Developed by the former SETAC WG on Data Availability and Quality 1998-2001.
- CML: Handbook on Life Cycle Assessment, Operational Guide to the ISO Standards. CML 2002 ([www.leidenuniv.nl/cml/ssp/projects/lca](http://www.leidenuniv.nl/cml/ssp/projects/lca))
- Curran M. A. (2007): Co-Product and Input Allocation Approaches for Creating Life Cycle Inventory Data: A literature Review. International Journal of Life Cycle Assessment (2007) 12:65-78.
- Ecobilan: DEAM<sup>TM</sup> methodical handbook, 2005 ([http://www.ecobilan.com/uk\\_deam.php](http://www.ecobilan.com/uk_deam.php))
- Ekvall, T., Tillman; A.-M.; Molander, S. (2005). Normative ethics and methodology for life cycle assessment. Journal of Cleaner Production 13 (2005) pp 1225-1234.

- Finnveden, G. (2008). A world with CO<sub>2</sub> caps – Electricity production in consequential assessments. Editorial in: *International Journal of Life Cycle Assessment* (2008) 13:365-367.
- Frank C. et al.: SETAC Guidelines for Life Cycle Assessment: A “Code of Practice”, 1993.
- Frischknecht, R. (2007): Cut-off vs. avoided burden in metals’ recycling: in view of environmental sustainability, risk perception and eco-efficiency. Presentation held at: 33rd LCA forum. November 22, 2007, Lausanne, Switzerland.
- Griesshammer R & Hochfeld C. (2009): Position statement on measurement and communication of the product carbon footprint for international standardization and harmonization purposes. ([http://www.bmu.de/files/pdfs/allgemein/application/pdf/memorandum\\_pcf\\_en\\_bf.pdf](http://www.bmu.de/files/pdfs/allgemein/application/pdf/memorandum_pcf_en_bf.pdf), accessed Jan 2010)
- Guinée, J. B. (Ed.) 2002: Handbook on Life Cycle Assessment - Operational Guide to the ISO Standards. Series: Eco-Efficiency in Industry and Science, Vol. 7. 2002, 708 p., Softcover. ISBN: 1-4020-0557-1.
- Hauschild, M.Z. & Wenzel, H. (1998). Environmental assessment of products. Vol. 2 - Scientific background, 565 pp. Chapman & Hall, United Kingdom, Kluwer Academic Publishers, Hingham, MA. USA. ISBN 0412 80810 2.
- Heijungs, R. & Guinee, J. B. (2007). Allocation and ‘what-if’ scenarios in life cycle assessment of waste management systems. *Waste Management* 27 (2007) pp 997-1005.
- Hellweg, S. & Frischknecht, R. 2004: "Evaluation of Long-Term Impacts in LCA." In *Int J LCA* Vol. 9 (5): 339-341.
- IPCC (2006): 2006 IPCC Guidelines for National Greenhouse Gas Inventories. Volume 4. Agriculture, Forestry and Other Land Use. (accessed at <http://www.ipcc-nggip.iges.or.jp/public/2006gl/vol4.html>)
- Jensen, A. A.; Hoffmann L.; Møller B. et al. (1997): Life Cycle Assessment. A guide to approaches, experiences and information sources. Environmental Issues Series No. 6. European Environmental Agency, 1997.
- Kemna, K.; van Elburg, M.; Li, W.; van Holstein, R. (2005). MEEUP Methodology Report. Final report to the European Commission, dated 28.11.2005.
- LBP University of Stuttgart / PE International: GaBi handbook and GaBi modelling principles, 2006 ([www.gabi-software.com](http://www.gabi-software.com))
- Lindfors, L.-G.; Christiansen, K.; Hoffman, L.; Virtanen, Y.; Juntilla, V.; Hanssen, O.-J.; Rønning, A.; Ekvall, T.; and Finnveden, G. (1995). Nordic Guidelines on Life-Cycle Assessment. (Copenhagen: Nordic Council of Ministers).
- Margni, M.; Lesage, P.; Michaud R.; Belley, C.; Clément, E.; Samson, R. (2008): Presentation at LCM2009 on “Extending System Boundaries to Capture Indirect Effects on LCA – An Enlightening Example!” (<http://www.lcm2009.org/presentations/OR19%20-%20Margni.pdf>, accessed online October 2009).
- NN (2007): General programme instructions for an International EPD®system for environmental product declarations, Draft Version 0.3 - dated 2007-11-09.

- NN: Meeting report of the “International Workshop on Quality of LCI Data”; FZK; Karlsruhe, Germany, 2003
- Pehnt M. (2005): Dynamic life cycle assessment (LCA) of renewable energy technologies. *Renewable Energy* 31 (2006) 55-71.
- Reap, J.; Roman, F.; Duncan, S.; Bras, B. (2008). A survey of unresolved problems in life cycle assessment. Part 1: goal and scope and inventory analysis. *Int J LCA* 13(4); June 2008.
- Sanden, B.A. & Karlström, M. (2007). Positive and negative feedback in consequential life-cycle assessment. *Journal of Cleaner Production* 15 (2007) pp 1469-1481.
- UNEP/SETAC Life Cycle Initiative, Life Cycle Inventory programme, First phase 2001-2005:
  - Task Force 2, chapter 4"; Draft version by IVAM, Amsterdam and IKP, Stuttgart.
  - Task force 3: Frankl, P.; Fullana, P.; Kreissig, J.: Communication of life cycle information in the building and energy sectors; Reviewed Final Draft version 4.2. July 2007
  - Task force 3: Lundie, S.; Citroth, A.; Huppel, G.: Inventory methods in LCA: towards consistency and improvement. Final report. June 2007
- Weidema, B. (2003). Market information in life cycle assessment. Environmental Project No. 863 2003. Danish Environmental Protection Agency
- Weidema, B.; Cappellaro, F.; Carlson, R.; Notten, P. Pålsson, A.-C.; Patyk, A.; Regalini, E.; Sacchetto, F.; Scalbi, S. (2004): Procedural guideline for the collection, treatment, and quality documentation of LCA data. Printed by ENEA. ISBN 88-8286-110-4
- Wenzel, H. (1998). Application Dependency of LCA Methodology: Key Variables and Their Mode of Influencing the Method, *International Journal of LCA* 3, 281-288.
- Wenzel, H.; Hauschild M.Z.; and Alting, L. (1997). Environmental assessment of products. Vol. 1 - Methodology, tools and case studies in product development, 544 pp. Chapman & Hall, United Kingdom, Kluwer Academic Publishers, Hingham, MA. USA. ISBN 0 412 80800 5.
- Zamagni, A.; Buttol, P.; Porta, P.L.; Buonamici, R.; Masoni, P., Guinee, J.; Heijungs, R.; Ekvall, T.; Bersani, R.; Bienkowska, A.; Pretato, U. (2008). Critical review of the current research needs and limitations related to ISO-LCA practice. CALCAS project report D7. Published and printed by ENEA, Italy. ISBN 88-8286-166-X

European Commission

EUR 24708 EN – Joint Research Centre – Institute for Environment and Sustainability

Title: International Reference Life Cycle Data System (ILCD) Handbook - General guide for Life Cycle Assessment - Detailed guidance.

Author(s): -

Luxembourg: Publications Office of the European Union

2010 – 398 pp. –21.0 x 29.7 cm

EUR – Scientific and Technical Research series – ISSN 1018-5593

ISBN 978-92-79-19092-6

doi:10.2788/38479

Cite as: European Commission - Joint Research Centre - Institute for Environment and Sustainability: International Reference Life Cycle Data System (ILCD) Handbook - General guide for Life Cycle Assessment - Detailed guidance. First edition March 2010. EUR 24708 EN. Luxembourg. Publications Office of the European Union; 2010.

#### Abstract

Life Cycle Thinking (LCT) and Life Cycle Assessment (LCA) are the scientific approaches behind modern environmental policies and business decision support related to Sustainable Consumption and Production (SCP). The International Reference Life Cycle Data System (ILCD) provides a common basis for consistent, robust and quality-assured life cycle data and studies. Such data and studies support coherent SCP instruments, such as Ecolabelling, Ecodesign, Carbon footprinting, and Green Public Procurement. This guide is a component of the International Reference Life Cycle Data System (ILCD) Handbook. It provides technical guidance for detailed Life Cycle Assessment (LCA) studies and provides the technical basis to derive product-specific criteria, guides, and simplified tools. It is based on and conforms to the ISO 14040 and 14044 standards on LCA. The principle target audience for this guide is the LCA practitioner as well as technical experts in the public and private sector dealing with environmental decision support related to products, resources, and waste management.

### **How to obtain EU publications**

Our priced publications are available from EU Bookshop (<http://bookshop.europa.eu>), where you can place an order with the sales agent of your choice.

The Publications Office has a worldwide network of sales agents. You can obtain their contact details by sending a fax to (352) 29 29-42758.



The mission of the JRC is to provide customer-driven scientific and technical support for the conception, development, implementation and monitoring of EU policies. As a service of the European Commission, the JRC functions as a reference centre of science and technology for the Union. Close to the policy-making process, it serves the common interest of the Member States, while being independent of special interests, whether private or national.



LB-NA-24708-EN-C

